

**COMMONWEALTH OF KENTUCKY
TRANSPORTATION CABINET
FRANKFORT, KY 40622**

MANUAL TITLE: Kentucky Methods Manual

REVISION NO.: 38

DATE REQUESTED: September 4, 2024

REPRINT: _____

REQUESTED BY: Kim Jasper

NEW: _____

NEW PROCEDURES

CHAPTER/ SECTION	EXPLANATION	OLD PAGES TO BE DELETED	NEW PAGES TO BE ADDED
KM-100	<p>The purpose of this printing is to include the following new procedures in the <i>Kentucky Methods Manual</i>. This revision also includes an updated table of contents.</p> <p>Approval Process for Producers of Culvert Pipe</p>	KM 64-115-24 (04/24/24)	KM 64-115-24 (09/04/24)
Produced & Distributed by the Organizational Management Branch			

**COMMONWEALTH OF KENTUCKY
TRANSPORTATION CABINET
FRANKFORT, KY 40622**

MANUAL TITLE: Kentucky Methods Manual

REVISION NO.: 37

DATE REQUESTED: April 24, 2024

REPRINT: _____

REQUESTED BY: Kim Jasper

NEW: _____

NEW PROCEDURES

CHAPTER/ SECTION	EXPLANATION	OLD PAGES TO BE DELETED	NEW PAGES TO BE ADDED
KM-100	<p>The purpose of this printing is to include the following new procedures in the <i>Kentucky Methods Manual</i>. This revision also includes an updated table of contents.</p> <p>Approval Process for Producers of Culvert Pipe</p>	KM 64-115-12	KM 64-115-24
<p>Produced & Distributed by the Organizational Management Branch</p>			

**COMMONWEALTH OF KENTUCKY
TRANSPORTATION CABINET
FRANKFORT, KY 40622**

MANUAL TITLE: Kentucky Methods Manual

REVISION NO.: 36

DATE REQUESTED: March 20, 2024

REPRINT: _____

REQUESTED BY: Kim Jasper

NEW: _____

NEW PROCEDURES

CHAPTER/ SECTION	EXPLANATION	OLD PAGES TO BE DELETED	NEW PAGES TO BE ADDED
KM-200	<p>The purpose of this printing is to include the following new procedures in the <i>Kentucky Methods Manual</i>. This revision also includes an updated table of contents.</p> <p>Test Method for Thermoplastic Pavement Marking Materials</p>	KM 64-268-20	KM 64-268-24
<p>Produced & Distributed by the Organizational Management Branch</p>			

**COMMONWEALTH OF KENTUCKY
TRANSPORTATION CABINET
FRANKFORT, KY 40622**

MANUAL TITLE: Kentucky Methods Manual

REVISION NO.: 35

DATE REQUESTED: February 22, 2023

REPRINT: _____

REQUESTED BY: Kim Jasper

NEW: _____

NEW PROCEDURES

CHAPTER/ SECTION	EXPLANATION	OLD PAGES TO BE DELETED	NEW PAGES TO BE ADDED
KM-200	<p>The purpose of this printing is to include the following new procedures in the <i>Kentucky Methods Manual</i>. This revision also includes an updated table of contents.</p> <p>Evaluation of Retroreflectivity on Intersection Pavement Markings Using Portable Hand-Operated Instruments</p> <p>Evaluation of Retroreflectivity on Pavement Markings Using Portable Hand-Operated Instruments</p>	<p>KM 64-201-08</p> <p>KM 64-202-12</p>	<p>KM 64-201-23</p> <p>KM 64-202-23</p>
Produced & Distributed by the Organizational Management Branch			

**COMMONWEALTH OF KENTUCKY
TRANSPORTATION CABINET
FRANKFORT, KY 40622**

MANUAL TITLE: Kentucky Methods Manual

REVISION NO.: 34

DATE REQUESTED: July 26, 2022

REPRINT: _____

REQUESTED BY: Kim Jasper

NEW: _____

NEW PROCEDURES

CHAPTER/ SECTION	EXPLANATION	OLD PAGES TO BE DELETED	NEW PAGES TO BE ADDED
KM-400	<p>The purpose of this printing is to include the following new procedures in the <i>Kentucky Methods Manual</i>. This revision also includes an updated table of contents.</p> <p>Establishing the Job-Mix Formula of Asphalt Mixtures by the Contractor Method for Verifying a Contractor's Laboratory Mix Design Determination of Cracking Resistance (KYCT) of Bituminous Mixtures</p>	<p>KM-64-421-09 KM-64-443-05 KM-64-450-19</p>	<p>KM 64-421-22 KM 64-443-22 KM-64-450-22</p>
Produced & Distributed by the Organizational Management Branch			

**COMMONWEALTH OF KENTUCKY
TRANSPORTATION CABINET
FRANKFORT, KY 40622**

MANUAL TITLE: Kentucky Methods Manual

REVISION NO.: 33

DATE REQUESTED: November 5, 2021

REPRINT: _____

REQUESTED BY: Kim Jasper

NEW: _____

NEW PROCEDURES

CHAPTER/ SECTION	EXPLANATION	OLD PAGES TO BE DELETED	NEW PAGES TO BE ADDED
KM-300	<p>The purpose of this printing is to include the following new procedure in the <i>Kentucky Methods Manual</i>. This revision also includes an updated table of contents.</p> <p>Acceptance Procedures for Fly Ash for Concrete</p>	KM-64-325-08	KM 64-325-21
<p>Produced & Distributed by the Organizational Management Branch</p>			

**COMMONWEALTH OF KENTUCKY
TRANSPORTATION CABINET
FRANKFORT, KY 40622**

MANUAL TITLE: Kentucky Methods Manual

REVISION NO.: 32

DATE REQUESTED: March 29, 2021

REPRINT: _____

REQUESTED BY: Kim Jasper

NEW: _____

NEW PROCEDURES

CHAPTER/ SECTION	EXPLANATION	OLD PAGES TO BE DELETED	NEW PAGES TO BE ADDED
KM-200	<p>The purpose of this printing is to include the following new procedure in the <i>Kentucky Methods Manual</i>. This revision also includes an updated table of contents.</p> <p>Performance Based Evaluation and Acceptance of Retroreflective Sign Sheeting</p>	KM-64-204-20	KM 64-204-21
<p>Produced & Distributed by the Organizational Management Branch</p>			

**COMMONWEALTH OF KENTUCKY
TRANSPORTATION CABINET
FRANKFORT, KY 40622**

MANUAL TITLE: Kentucky Methods Manual

REVISION NO.: 31

DATE REQUESTED: March 26, 2021

REPRINT: _____

REQUESTED BY: Kim Jasper

NEW: _____

NEW PROCEDURES

CHAPTER/ SECTION	EXPLANATION	OLD PAGES TO BE DELETED	NEW PAGES TO BE ADDED
KM-300	<p>The purpose of this printing is to include the following new procedure in the <i>Kentucky Methods Manual</i>. This revision also includes an updated table of contents.</p> <p>Evaluation of Concrete Cylinder Results</p>	KM 64-314-08	KM 64-314-21
<p>Produced & Distributed by the Organizational Management Branch</p>			

**COMMONWEALTH OF KENTUCKY
TRANSPORTATION CABINET
FRANKFORT, KY 40622**

MANUAL TITLE: Kentucky Methods Manual

REVISION NO.: 30

DATE REQUESTED: May 6, 2020

REPRINT: _____

REQUESTED BY: Kim Jasper

NEW: _____

NEW PROCEDURES

CHAPTER/ SECTION	EXPLANATION	OLD PAGES TO BE DELETED	NEW PAGES TO BE ADDED
KM-200	<p>The purpose of this printing is to include the following new procedure in the <i>Kentucky Methods Manual</i>. This revision also includes an updated table of contents.</p> <p>Performance Based Evaluation and Acceptance of Retroreflective Sign Sheeting</p>		KM 64-204-20
<p>Produced & Distributed by the Organizational Management Branch</p>			

**COMMONWEALTH OF KENTUCKY
TRANSPORTATION CABINET
FRANKFORT, KY 40622**

MANUAL TITLE: Kentucky Methods Manual

REVISION NO.: 29

DATE REQUESTED: April 7, 2020

REPRINT: _____

REQUESTED BY: Kim Jasper

NEW: _____

NEW PROCEDURES

CHAPTER/ SECTION	EXPLANATION	OLD PAGES TO BE DELETED	NEW PAGES TO BE ADDED
KM-200	<p>The purpose of this printing is to include the following new procedure in the <i>Kentucky Methods Manual</i>. This revision also includes an updated table of contents.</p> <p>Performance Based Evaluation and Acceptance of Pavement Markers</p>		KM 64-206-20
<p>Produced & Distributed by the Organizational Management Branch</p>			

**COMMONWEALTH OF KENTUCKY
TRANSPORTATION CABINET
FRANKFORT, KY 40622**

MANUAL TITLE: Kentucky Methods Manual

REVISION NO.: 28

DATE REQUESTED: February 28, 2020

REPRINT: _____

REQUESTED BY: Kim Jasper

NEW: _____

NEW PROCEDURES

CHAPTER/ SECTION	EXPLANATION	OLD PAGES TO BE DELETED	NEW PAGES TO BE ADDED
KM-200	<p>The purpose of this printing is to include the following revised procedures in the <i>Kentucky Methods Manual</i>. This revision also includes an updated table of contents.</p> <p>Test Method For Thermoplastic Pavement Marking Materials</p>	KM 64-268-19	KM 64-268-20
<p>Produced & Distributed by the Organizational Management Branch</p>			

**COMMONWEALTH OF KENTUCKY
TRANSPORTATION CABINET
FRANKFORT, KY 40622**

MANUAL TITLE: Kentucky Methods Manual

REVISION NO.: 27

DATE REQUESTED: September 24, 2019

REPRINT: _____

REQUESTED BY: Kim Jasper

NEW: _____

NEW PROCEDURES

CHAPTER/ SECTION	EXPLANATION	OLD PAGES TO BE DELETED	NEW PAGES TO BE ADDED
KM-200	<p>The purpose of this printing is to include the following revised procedures in the <i>Kentucky Methods Manual</i>. This revision also includes an updated table of contents.</p> <p>Performance Based Evaluation and Acceptance Criteria of Concrete Coatings Systems for Inclusion on the List of Approved Materials</p>		KM 64-269-19
<p>Produced & Distributed by the Organizational Management Branch</p>			

**COMMONWEALTH OF KENTUCKY
TRANSPORTATION CABINET
FRANKFORT, KY 40622**

MANUAL TITLE: Kentucky Methods Manual

REVISION NO.: 26

DATE REQUESTED: September 23, 2019

REPRINT: _____

REQUESTED BY: Kim Jasper

NEW: _____

NEW PROCEDURES

CHAPTER/ SECTION	EXPLANATION	OLD PAGES TO BE DELETED	NEW PAGES TO BE ADDED
KM-200	<p>The purpose of this printing is to include the following revised procedures in the <i>Kentucky Methods Manual</i>. This revision also includes an updated table of contents.</p> <p>Test Method for Thermoplastic Pavement Marking Materials</p>		KM 64-268-19
<p>Produced & Distributed by the Organizational Management Branch</p>			

**COMMONWEALTH OF KENTUCKY
TRANSPORTATION CABINET
FRANKFORT, KY 40622**

MANUAL TITLE: Kentucky Methods Manual

REVISION NO.: 25

DATE REQUESTED: September 3, 2019

REPRINT: _____

REQUESTED BY: Kim Jasper

NEW: _____

NEW PROCEDURES

CHAPTER/ SECTION	EXPLANATION	OLD PAGES TO BE DELETED	NEW PAGES TO BE ADDED
KM-200	<p>The purpose of this printing is to include the following revised procedures in the <i>Kentucky Methods Manual</i>. This revision also includes an updated table of contents.</p> <p>Performance Based Evaluation and Acceptance of Pavement Marking Materials</p>		KM 64-207-19
Produced & Distributed by the Organizational Management Branch			

**COMMONWEALTH OF KENTUCKY
TRANSPORTATION CABINET
FRANKFORT, KY 40622**

MANUAL TITLE: Kentucky Methods Manual

REVISION NO.: 24

DATE REQUESTED: August 20, 2019

REPRINT: _____

REQUESTED BY: Kim Jasper

NEW: _____

NEW PROCEDURES

CHAPTER/ SECTION	EXPLANATION	OLD PAGES TO BE DELETED	NEW PAGES TO BE ADDED
KM-200	<p>The purpose of this printing is to include the following revised procedures in the <i>Kentucky Methods Manual</i>. This revision also includes an updated table of contents.</p> <p>Test Method for Insoluble Residue in Carbonate Aggregates</p>	KM 64-265-19	KM 64-265-19
<p>Produced & Distributed by the Organizational Management Branch</p>			

**COMMONWEALTH OF KENTUCKY
TRANSPORTATION CABINET
FRANKFORT, KY 40622**

MANUAL TITLE: Kentucky Methods Manual

REVISION NO.: 23

DATE REQUESTED: June 17, 2019

REPRINT: _____

REQUESTED BY: Brad Webb

NEW: _____

NEW PROCEDURES

CHAPTER/ SECTION	EXPLANATION	OLD PAGES TO BE DELETED	NEW PAGES TO BE ADDED
	The purpose of this printing is to include the following revised procedures in the <i>Kentucky Methods Manual</i> . This revision also includes an updated table of contents.		
KM-400	Determination of Cracking Resistance (KYCT) of Bituminous Mixtures Non-Tracking Tack Approval for Use	KM 64-450-19 KM 64-451-19	KM 64-450-19 KM 64-451-19
Produced & Distributed by the Organizational Management Branch			

**COMMONWEALTH OF KENTUCKY
TRANSPORTATION CABINET
FRANKFORT, KY 40622**

MANUAL TITLE: Kentucky Methods Manual

REVISION NO.: 22

DATE REQUESTED: January 10, 2019

REPRINT: _____

REQUESTED BY: Kim Jasper

NEW: _____

REVISED PROCEDURE

CHAPTER/ SECTION	EXPLANATION	OLD PAGES TO BE DELETED	NEW PAGES TO BE ADDED
KM-100	<p>The purpose of this printing is to include the following revised procedures in the <i>Kentucky Methods Manual</i>. This revision also includes an updated table of contents.</p> <p>Testing and Acceptance of Steel Reinforcing Bars (Uncoated and Coated)</p>	KM 64-101-08	KM 64-101-19
<p>Produced & Distributed by the Organizational Management Branch</p>			

**COMMONWEALTH OF KENTUCKY
TRANSPORTATION CABINET
FRANKFORT, KY 40622**

MANUAL TITLE: Kentucky Methods Manual

REVISION NO.: 21

DATE REQUESTED: December 14, 2018

REPRINT: _____

REQUESTED BY: Kim Jasper

NEW: _____

REVISED PROCEDURE

CHAPTER/ SECTION	EXPLANATION	OLD PAGES TO BE DELETED	NEW PAGES TO BE ADDED
KM-300	<p>The purpose of this printing is to include the following revised procedures in the <i>Kentucky Methods Manual</i>. This revision also includes an updated table of contents.</p> <p>Measurement of Bridge Deck Reinforcement Cover</p>	KM 64-313-17	KM 64-313-18
<p>Produced & Distributed by the Organizational Management Branch</p>			

**COMMONWEALTH OF KENTUCKY
TRANSPORTATION CABINET
FRANKFORT, KY 40622**

MANUAL TITLE: Kentucky Methods Manual

REVISION NO.: 20

DATE REQUESTED: October 11, 2017

REPRINT: _____

REQUESTED BY: Kim Jasper

NEW: _____

REVISED PROCEDURE

CHAPTER/ SECTION	EXPLANATION	OLD PAGES TO BE DELETED	NEW PAGES TO BE ADDED
KM-300	<p>The purpose of this printing is to include the following revised procedures in the <i>Kentucky Methods Manual</i>. This revision also includes an updated table of contents.</p> <p>Coring Rigid Pavement for Thickness</p>	KM 64-309-08	KM 64-309-17
<p>Produced & Distributed by the Organizational Management Branch</p>			

**COMMONWEALTH OF KENTUCKY
TRANSPORTATION CABINET
FRANKFORT, KY 40622**

MANUAL TITLE: Kentucky Methods Manual

REVISION NO.: 19

DATE REQUESTED: September 11, 2017

REPRINT: _____

REQUESTED BY: Kim Jasper

NEW: _____

REVISED PROCEDURE

CHAPTER/ SECTION	EXPLANATION	OLD PAGES TO BE DELETED	NEW PAGES TO BE ADDED
KM-600	<p>The purpose of this printing is to include the following revised procedures in the <i>Kentucky Methods Manual</i>. This revision also includes an updated table of contents.</p> <p>Sampling of Aggregates for Use as Highway Materials</p>	KM 64-601-16	KM 64-601-17
<p>Produced & Distributed by the Organizational Management Branch</p>			

**COMMONWEALTH OF KENTUCKY
TRANSPORTATION CABINET
FRANKFORT, KY 40622**

MANUAL TITLE: Kentucky Methods Manual

REVISION NO.: 18

DATE REQUESTED: May 31, 2017

REPRINT: _____

REQUESTED BY: Kim Jasper

NEW: _____

REVISED PROCEDURE

CHAPTER/ SECTION	EXPLANATION	OLD PAGES TO BE DELETED	NEW PAGES TO BE ADDED
	The purpose of this printing is to include the following revised procedures in the <i>Kentucky Methods Manual</i> . This revision also includes an updated table of contents.		
KM-400	Kentucky Transportation Cabinet (KYTC) Approved Supplier Certification (ASC) Program for Performance-Graded (PG) Asphalt Binders	KM 64-444-06	KM 64-444-17
	Kentucky Transportation Cabinet (KYTC) Emulsified Asphalts Supplier Certification (EASC) Program	KM 64-445-05	KM 64-445-17
Produced & Distributed by the Organizational Management Branch			

**COMMONWEALTH OF KENTUCKY
TRANSPORTATION CABINET
FRANKFORT, KY 40622**

MANUAL TITLE: Kentucky Methods Manual

REVISION NO.: 17

DATE REQUESTED: April 7, 2017

REPRINT: _____

REQUESTED BY: Kim Jasper

NEW: _____

REVISED PROCEDURE

CHAPTER/ SECTION	EXPLANATION	OLD PAGES TO BE DELETED	NEW PAGES TO BE ADDED
	The purpose of this printing is to include the following revised procedures in the <i>Kentucky Methods Manual</i> . This revision also includes an updated table of contents.		
KM-100	Standard Operating Procedure for Acceptance of Guardrail Systems		KM 64-116-17
KM-600	Specific Gravity and Absorption of Coarse Aggregates		KM 64-607-17
Produced & Distributed by the Organizational Management Branch			

**COMMONWEALTH OF KENTUCKY
TRANSPORTATION CABINET
FRANKFORT, KY 40622**

MANUAL TITLE: Kentucky Methods Manual

REVISION NO.: 16

DATE REQUESTED: February 23, 2017

REPRINT: _____

REQUESTED BY: Kim Jasper

NEW: _____

REVISED PROCEDURE

CHAPTER/ SECTION	EXPLANATION	OLD PAGES TO BE DELETED	NEW PAGES TO BE ADDED
	The purpose of this printing is to include the following revised procedures in the <i>Kentucky Methods Manual</i> . This revision also includes an updated table of contents.		
KM-00	Kentucky Transportation Cabinet Qualification Program For Technicians	KM 64-001-08	KM 64-001-17
KM-300	Qualification Process for Producers of Ready Mix Concrete	KM 64-323-16	KM 64-323-17
Produced & Distributed by the Organizational Management Branch			

**COMMONWEALTH OF KENTUCKY
TRANSPORTATION CABINET
FRANKFORT, KY 40622**

MANUAL TITLE: Kentucky Methods Manual

REVISION NO.: 15

DATE REQUESTED: January 3, 2017

REPRINT: _____

REQUESTED BY: Kim Jasper

NEW: _____

REVISED PROCEDURE

CHAPTER/ SECTION	EXPLANATION	OLD PAGES TO BE DELETED	NEW PAGES TO BE ADDED
KM-300	<p>The purpose of this printing is to include the following revised procedures in the <i>Kentucky Methods Manual</i>. This revision also includes an updated table of contents.</p> <p>Measurement of Bridge Deck Reinforcement Cover</p>	KM 64-313-08	KM 64-313-17
<p>Produced & Distributed by the Organizational Management Branch</p>			

**COMMONWEALTH OF KENTUCKY
TRANSPORTATION CABINET
FRANKFORT, KY 40622**

MANUAL TITLE: Kentucky Methods Manual

REVISION NO.: 14

DATE REQUESTED: November 4, 2016

REPRINT: _____

REQUESTED BY: Kim Jasper

NEW: _____

REVISED PROCEDURE

CHAPTER/ SECTION	EXPLANATION	OLD PAGES TO BE DELETED	NEW PAGES TO BE ADDED
KM-600	The purpose of this printing is to include the following revised procedures in the <i>Kentucky Methods Manual</i> . This revision also includes an updated table of contents.		
	Determination of the Percentage of Shale in Aggregate	KM 64-604-14	KM 64-604-16
	Flat and Elongated Particles in Coarse Aggregates	KM 64-630-16	KM 64-630-16
	Percentage of Crushed Particles in Coarse Aggregate	KM 64-631-16	KM 64-631-16
	Reducing Samples of Aggregate for Testing Purposes		KM 64-632-16
Produced & Distributed by the Organizational Management Branch			

**COMMONWEALTH OF KENTUCKY
TRANSPORTATION CABINET
FRANKFORT, KY 40622**

MANUAL TITLE: Kentucky Methods Manual

REVISION NO.: 13

DATE REQUESTED: September 16, 2016

REPRINT: _____

REQUESTED BY: Kim Jasper

NEW: _____

REVISED PROCEDURE

CHAPTER/ SECTION	EXPLANATION	OLD PAGES TO BE DELETED	NEW PAGES TO BE ADDED
KM-600	<p>The purpose of this printing is to include the following revised procedures in the <i>Kentucky Methods Manual</i>. This revision also includes an updated title page, introduction, and table of contents.</p> <p>Flat and Elongated Particles in Coarse Aggregates</p> <p>Percentage of Crushed Particles in Coarse Aggregate</p>		<p>KM 64-630-16</p> <p>KM 64-631-16</p>
<p>Produced & Distributed by the Organizational Management Branch</p>			

**COMMONWEALTH OF KENTUCKY
TRANSPORTATION CABINET
FRANKFORT, KY 40622**

MANUAL TITLE: Kentucky Methods Manual

REVISION NO.: 12

DATE REQUESTED: August 8, 2016

REPRINT: _____

REQUESTED BY: Kim Jasper

NEW: _____

REVISED PROCEDURE

CHAPTER/ SECTION	EXPLANATION	OLD PAGES TO BE DELETED	NEW PAGES TO BE ADDED
KM-100	<p>The purpose of this printing is to include the following revised procedures in the <i>Kentucky Methods Manual</i>. This revision also includes an updated title page, introduction, and table of contents.</p> <p>Qualification of Steel Reinforcement Tack Welders</p>	KM 64-109-06	KM 64-109-08
<p>Produced & Distributed by the Organizational Management Branch</p>			

**COMMONWEALTH OF KENTUCKY
TRANSPORTATION CABINET
FRANKFORT, KY 40622**

MANUAL TITLE: Kentucky Methods Manual

REVISION NO.: 24

DATE REQUESTED: August 20, 2019

REPRINT: _____

REQUESTED BY: Kim Jasper

NEW: _____

NEW PROCEDURES

CHAPTER/ SECTION	EXPLANATION	OLD PAGES TO BE DELETED	NEW PAGES TO BE ADDED
KM-200	<p>The purpose of this printing is to include the following revised procedures in the <i>Kentucky Methods Manual</i>. This revision also includes an updated table of contents.</p> <p>Test Method for Insoluble Residue in Carbonate Aggregates</p>	KM 64-265-19	KM 64-265-19
<p>Produced & Distributed by the Organizational Management Branch</p>			

**COMMONWEALTH OF KENTUCKY
TRANSPORTATION CABINET
FRANKFORT, KY 40622**

MANUAL TITLE: Kentucky Methods Manual

REVISION NO.: 11

DATE REQUESTED: July 7, 2016

REPRINT: _____

REQUESTED BY: Kim Jasper

NEW: _____

REVISED PROCEDURE

CHAPTER/ SECTION	EXPLANATION	OLD PAGES TO BE DELETED	NEW PAGES TO BE ADDED
KM-300	<p>The purpose of this printing is to include the following revised procedures in the <i>Kentucky Methods Manual</i>. This revision also includes an updated table of contents.</p> <p>Qualification Process for Producers of Ready Mix Concrete</p>	KM 64-323-09	KM 64-323-16
<p>Produced & Distributed by the Organizational Management Branch</p>			

**COMMONWEALTH OF KENTUCKY
TRANSPORTATION CABINET
FRANKFORT, KY 40622**

MANUAL TITLE: Kentucky Methods Manual

REVISION NO.: 10

DATE REQUESTED: June 27, 2016

REPRINT: _____

REQUESTED BY: Kim Jasper

NEW: _____

REVISED PROCEDURE

CHAPTER/ SECTION	EXPLANATION	OLD PAGES TO BE DELETED	NEW PAGES TO BE ADDED
KM-300	<p>The purpose of this printing is to include the following revised procedures in the <i>Kentucky Methods Manual</i>. This revision also includes an updated table of contents.</p> <p>Method for Approval of Using Self Consolidating Concrete (SCC)</p>	KM 64-320-08	KM 64-320-16
<p>Produced & Distributed by the Organizational Management Branch</p>			

**COMMONWEALTH OF KENTUCKY
TRANSPORTATION CABINET
FRANKFORT, KY 40622**

MANUAL TITLE: Kentucky Methods Manual

REVISION NO.: 9

DATE REQUESTED: June 1, 2016

REPRINT: _____

REQUESTED BY: Kim Jasper

NEW: _____

REVISED PROCEDURE

CHAPTER/ SECTION	EXPLANATION	OLD PAGES TO BE DELETED	NEW PAGES TO BE ADDED
	The purpose of this printing is to include the following revised procedures in the <i>Kentucky Methods Manual</i> . This revision also includes an updated table of contents.		
KM-200	Evaluation of Retroreflectivity on Pavement Markings Using Portable Hand-Operated Instruments	KM 64-202-10	KM 64-202-12
KM-200	Evaluation of Retroreflectivity on Permanent Pavement Markings using Mobile 30 Meter Geometry Instruments	KM 64-203-10	KM 64-203-12
KM-300	10-Foot Rolling Straight Edge Test		KM 64-326-12
KM-400	Establishing the Job-Mix Formula of Asphalt Mixtures by the Contractor	KM 64-421-05	KM 64-421-09
KM-400	Requirements for Process-Control Testing and Inspection of Asphalt Mixtures by the Contractor	KM 64-426-12	KM 64-426-15
Produced & Distributed by the Organizational Management Branch			

**COMMONWEALTH OF KENTUCKY
TRANSPORTATION CABINET
FRANKFORT, KY 40622**

MANUAL TITLE: Kentucky Methods Manual

REVISION NO.: 8

DATE REQUESTED: May 20, 2016

REPRINT: _____

REQUESTED BY: Kim Jasper

NEW: _____

REVISED PROCEDURE

CHAPTER/ SECTION	EXPLANATION	OLD PAGES TO BE DELETED	NEW PAGES TO BE ADDED
KM-600	<p>The purpose of this printing is to include the following revised procedure in the <i>Kentucky Methods Manual</i>. This revision also includes an updated table of contents.</p> <p>Sampling of Aggregates for use as Highway Materials</p>		KM 64-601-16
<p>Produced & Distributed by the Organizational Management Branch</p>			

**COMMONWEALTH OF KENTUCKY
TRANSPORTATION CABINET
FRANKFORT, KY 40622**

MANUAL TITLE: Kentucky Methods Manual

REVISION NO.: 7

DATE REQUESTED: August 15, 2014

REPRINT: _____

REQUESTED BY: Brad Webb

NEW: _____

REVISED PROCEDURE

CHAPTER/ SECTION	EXPLANATION	OLD PAGES TO BE DELETED	NEW PAGES TO BE ADDED
KM-600	<p>The purpose of this printing is to include the following revised procedure in the <i>Kentucky Methods Manual</i>. This revision also includes an updated table of contents.</p> <p>Determination of the Percentage of Shale in Aggregate</p>	KM 64-604-08	KM 64-604-14
<p>Produced & Distributed by the Organizational Management Branch</p>			

**COMMONWEALTH OF KENTUCKY
TRANSPORTATION CABINET
FRANKFORT, KY 40622**

MANUAL TITLE: Kentucky Methods Manual

REVISION NO.: 6

DATE REQUESTED: August 15, 2014

REPRINT: _____

REQUESTED BY: Betty Ogden

NEW: _____

REVISED PROCEDURE

CHAPTER/ SECTION	EXPLANATION	OLD PAGES TO BE DELETED	NEW PAGES TO BE ADDED
	The purpose of this printing is to include the following revised procedure in the <i>Kentucky Methods Manual</i> . This revision also includes an updated table of contents.		
KM-100	Sampling Materials by Random Number Sampling	KM 64-113-08	KM 64-113-14
KM-600	Soundness of Aggregate by Use of Sodium Sulfate	KM 64-610-08	KM 64-610-14
	Determination of Coal and Lignite in Aggregates	KM 64-615-08	KM 64-615-14
	Metallic Iron Content in Slag	KM 64-618-08	KM 64-618-14
	Pore Index Value of Aggregate	KM 64-623-08	KM 64-623-14
	Resistance of Concrete to Freeze-Thaw Testing	KM 64-626-08	KM 64-626-14
	Length Change of Hardened Concrete Due to Alkali-Carbonate Reactivity	KM 64-629-08	KM 64-629-14
Produced & Distributed by the Organizational Management Branch			

**COMMONWEALTH OF KENTUCKY
TRANSPORTATION CABINET
FRANKFORT, KY 40622**

MANUAL TITLE: Kentucky Methods Manual

REVISION NO.: 5

DATE REQUESTED: May 22, 2014

REPRINT: _____

REQUESTED BY: Troy Teegarden

NEW: _____

REVISED PROCEDURE

CHAPTER/ SECTION	EXPLANATION	OLD PAGES TO BE DELETED	NEW PAGES TO BE ADDED
KM-100	<p>The purpose of this printing is to include the following revised procedure in the <i>Kentucky Methods Manual</i>. This revision also includes an updated table of contents.</p> <p>Camera/Video Inspection of Pipe With Alternate Methods of Deflection Measurement</p>	KM 64-114-08	KM 64-114-14
<p>Produced & Distributed by the Organizational Management Branch</p>			

**COMMONWEALTH OF KENTUCKY
TRANSPORTATION CABINET
FRANKFORT, KY 40622**

MANUAL TITLE: Kentucky Methods Manual

REVISION NO.: 4

DATE REQUESTED: December 21, 2012

REPRINT: _____

REQUESTED BY: Betty Ogden

NEW: _____

REVISED PROCEDURE

CHAPTER/ SECTION	EXPLANATION	OLD PAGES TO BE DELETED	NEW PAGES TO BE ADDED
KM-100	<p>The purpose of this printing is to include the following revised procedure in the <i>Kentucky Methods Manual</i>. This revision also includes an updated table of contents.</p> <p>Approval Process for Producers of Culvert Pipe</p>	KM-64-115-08	KM-64-115-12
<p>Produced & Distributed by the Organizational Management Branch</p>			

**COMMONWEALTH OF KENTUCKY
TRANSPORTATION CABINET
FRANKFORT, KY 40622**

MANUAL TITLE: Kentucky Methods Manual

REVISION NO.: 3

DATE REQUESTED: August 24, 2012

REPRINT: _____

REQUESTED BY: Brad Webb

NEW: _____

REVISED PROCEDURE

CHAPTER/ SECTION	EXPLANATION	OLD PAGES TO BE DELETED	NEW PAGES TO BE ADDED
KM-400	<p>The purpose of this printing is to include the revised policy, "Requirements for Process-Control Testing and Inspection of Asphalt Mixtures by the Contractor" in the <i>Kentucky Methods Manual</i>. This revision also includes an updated table of contents.</p> <p>Requirements for Process-Control Testing and Inspection of Asphalt Mixtures by the Contractor</p>	KM-64-426-09	KM-64-426-12
<p>Produced & Distributed by the Organizational Management Branch</p>			

KENTUCKY METHODS GUIDANCE MANUAL

<http://transportation.ky.gov/Organizational-Resources/Pages/Policy-Manuals-Library.aspx>

COMMONWEALTH OF KENTUCKY
TRANSPORTATION CABINET
DEPARTMENT OF HIGHWAYS

November 2008



Distributed by
Organizational Management Branch
Office of Human Resource Management



TRANSPORTATION CABINET

Frankfort, Kentucky 40622
www.transportation.ky.gov/

Steven L. Beshear
Governor

Joseph W. Prather
Secretary

OFFICE OF THE SECRETARY 105064
OFFICIAL ORDER

SUBJECT: *Kentucky Methods Manual*

This manual has been prepared to provide information and guidance to personnel of the Kentucky Transportation Cabinet. Its purpose is to establish uniformity in the interpretation and administration of laws, regulations, policies, and procedures applicable to the operations of the Division of Materials and its relationship with other units of the Cabinet.

The policies and procedures set forth herein are hereby approved and declared effective unless officially changed.

All previous instructions, written and oral, relative to or in conflict with this manual are hereby superseded.

Signed and approved this 9th day of December, 2008.

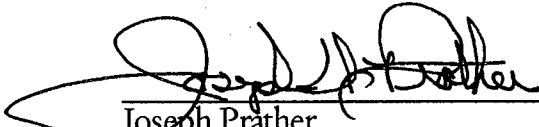
Joseph Prather
Secretary

Approved as to Legal Form

Office of Legal Services



INTRODUCTION

The testing procedures in this manual are utilized for the sampling and testing of materials incorporated into Kentucky Transportation Cabinet projects. ASTM, AASHTO, or other referenced standards also complement these methods. Applicable methods are defined by references in the *Kentucky Standard Specifications for Road and Bridge Construction*, Project Plans, or Special Notes for the appropriate material. The Kentucky Transportation Cabinet's Division of Materials within the Department of Highways develops and maintains the methods described in this manual. The division office in Frankfort serves as the Transportation Cabinet's central laboratory. When a method refers to a testing section, that section is a unit within the division.

The Division of Materials updates this manual annually, both online and in hard copy. Printed versions of the Kentucky Methods that are older than one year may be out-of-date. In an effort to provide the highway construction industry, public, and Transportation Cabinet personnel with current information, the division maintains these methods online (<http://transportation.ky.gov/Organizational-Resources/Pages/Policy-Manuals-Library.aspx>). Any user having difficulty accessing this location may contact his or her local district materials engineer (DME) or the division for assistance.

If you have comments or other suggestions, please contact the division at (502) 564-3160 or the following mailing address:

Kentucky Transportation Cabinet
Division of Materials
1227 Wilkinson Boulevard
Frankfort, KY 40601

To obtain a copy of this manual, contact the Organizational Management Branch, Office of Human Resource Management, at (502) 564-4610.

TABLE OF CONTENTS

KENTUCKY METHODS

GENERAL

KM 64-001-17	KENTUCKY TRANSPORTATION CABINET QUALIFICATION PROGRAM FOR TECHNICIANS
KM 64-002-08	NUCLEAR GAUGES USED FOR DENSITY OF VARIOUS MATERIALS
KM 64-003-10	APPROVAL OF NEW MATERIALS TO BE USED ON TRANSPORTATION PROJECTS IN KENTUCKY

PHYSICAL

KM 64-101-19	TESTING AND ACCEPTANCE OF STEEL REINFORCING BARS (UNCOATED AND COATED)
KM 64-102-08	TEST PROCEDURES FOR THE PLANT INSPECTION OF EPOXY COATED STEEL REINFORCEMENT.
KM 64-103-05	PREPARATION AND TESTING OF WELD SPECIMENS
KM 64-106-05	TEST PROCEDURES FOR EPOXY COATED REINFORCING BAR INSTALLATION MATERIALS
KM 64-107-05	FALLING - HEAD WATER PERMEABILITY OF FILTER FABRIC: DETERMINATION OF PERMEABILITY COEFFICIENT AND FLOW RATE AT A GIVEN CHANGE IN WATER HEAD
KM 64-108-05	QUALIFICATION OF GAS METAL ARC (MIG) WELDERS AND PREPARATION AND TESTING OF MIG WELD SPECIMENS
KM 64-109-08	QUALIFICATION OF STEEL REINFORCEMENT TACK WELDERS
KM 64-110-05	QUALIFICATION OF SHIELDED METAL ARC WELDERS
KM 64-112-05	NUMERICAL LIMITS FOR COMPARING TEST RESULTS (INDEPENDENT ASSURANCE SAMPLING AND TESTING PROGRAM)
KM 64-113-14	SAMPLING MATERIALS BY RANDOM NUMBER SAMPLING
KM 64-114-14	CAMERA/VIDEO INSPECTION OF PIPE WITH ALTERNATE METHODS OF DEFLECTION MEASUREMENT
KM 64-115-24	APPROVAL PROCESS FOR PRODUCERS OF CULVERT PIPE
KM 64-116-17	STANDARD OPERATING PROCEDURE FOR ACCEPTANCE OF GUARDRAIL SYSTEMS

TABLE OF CONTENTS

CHEMISTRY

KM 64-201-23	EVALUATION OF RETROREFLECTIVITY ON INTERSECTION PAVEMENT MARKINGS USING PORTABLE HAND-OPERATED INSTRUMENTS
KM 64-202-23	EVALUATION OF RETROREFLECTIVITY ON PAVEMENT MARKINGS USING PORTABLE HAND-OPERATED INSTRUMENTS
KM 64-203-12	EVALUATION OF RETROREFLECTIVITY ON PERMANENT PAVEMENT MARKINGS USING MOBILE 30 METER GEOMETRY INSTRUMENTS
KM 64-204-21	PERFORMANCE BASED EVALUATION AND ACCEPTANCE OF RETROREFLECTIVE SIGN SHEETING
KM 64-206-20	PERFORMANCE BASED EVALUATION AND ACCEPTANCE OF PAVEMENT MARKERS
KM 64-207-19	PERFORMANCE BASED EVALUATION AND ACCEPTANCE OF PAVEMENT MARKING MATERIALS
KM 64-209-08	PULL - OUT TEST FOR RE-BAR ANCHOR SYSTEMS
KM 64-210-08	CHLORIDE CONTENT (CONCRETE ADMIXTURES)
KM 64-221-08	AGRICULTURAL LIMESTONE
KM 64-222-08	CALCIUM CHLORIDE
KM 64-224-08	CHEMICAL ANALYSIS OF LIMESTONE, FINE AGGREGATE, QUICKLIME AND HYDRATED LIME
KM 64-225-08	SODIUM CHLORIDE
KM 64-226-08	WATER FOR USE WITH CEMENT
KM 64-227-08	WATER - BORNE PRESERVATIVES
KM 64-241-08	FERTILIZER
KM 64-242-08	HERBICIDES
KM 64-243-08	SAMPLING AND TESTING SOILS (CHEMICAL)
KM 64-250-08	ANALYSIS FOR ISOCYANATE CONTENT
KM 64-251-08	HUMIDITY CHAMBER ANALYSIS OF TRAFFIC PAINTS
KM 64-253-08	CHEMICAL ANALYSIS OF FLY ASH AND MICROSILICA
KM 64-254-08	CHEMICAL ANALYSIS OF CEMENT
KM 64-256-08	RESISTANCE TESTING OF STRUCTURAL STEEL COATINGS TO METHYL ETHYL KETONE
KM 64-257-08	ANALYSIS FOR HINDERED AMINE LIGHT STABILIZER (HALS)
KM 64-258-08	MEASUREMENT AND ACCEPTANCE OF FILM THICKNESS OF STRUCTURAL STEEL COATINGS
KM 64-261-08	TEST METHOD FOR ANALYSIS FOR AMINE CONTENT
KM 64-262-08	TEST METHOD FOR THE ANALYSIS OF BASE NUMBER
KM 64-263-08	TEST METHOD FOR ANALYSIS OF CALCIUM SULFONATE
KM 64-264-08	TEST METHOD FOR ANALYSIS OF EPOXY CONTENT
KM 64-265-19	TEST METHOD FOR INSOLUBLE RESIDUE IN CARBONATE AGGREGATES

TABLE OF CONTENTS

KM 64-266-08	PERFORMANCE BASED EVALUATION AND ACCEPTANCE OF STRUCTURAL STEEL COATING SYSTEMS
KM 64-267-10	QUALIFICATIONS OF MONITORING SYSTEMS FOR PAVEMENT MARKINGS APPLICATION VEHICLES
KM 64-268-24	TEST METHOD FOR THERMOPLASTIC PAVEMENT MARKING MATERIALS
KM 64-269-19	PERFORMANCE BASED EVALUATION AND ACCEPTANCE CRITERIA OF CONCRETE COATINGS SYSTEMS FOR INCLUSION ON THE LIST OF APPROVED MATERIALS

CONCRETE & CEMENT

KM 64-301-08	SAMPLING FRESH CONCRETE
KM 64-302-08	SLUMP OF PORTLAND CEMENT CONCRETE
KM 64-303-08	AIR CONTENT OF FRESHLY MIXED CONCRETE BY THE PRESSURE METHOD
KM 64-304-08	AIR CONTENT OF FRESHLY MIXED CONCRETE BY THE VOLUMETRIC METHOD
KM 64-305-08	MAKING AND CURING CONCRETE STRENGTH (COMPRESSIVE) TEST SPECIMENS IN THE FIELD
KM 64-306-08	TEST FOR FREE MOISTURE CONTENT OF CONCRETE AGGREGATES
KM 64-308-08	METHOD OF MEASURING LENGTH OF DRILLED CORES
KM 64-309-17	CORING RIGID PAVEMENT FOR THICKNESS
KM 64-311-08	CONCRETE “TRUCK MIXER” INSPECTION PROCEDURE
KM 64-312-08	CALIBRATION OF CONTINUOUS-TYPE MIXERS (CONCRETE MOBILES)
KM 64-313-18	MEASUREMENT OF BRIDGE DECK REINFORCEMENT COVER
KM 64-314-08	EVALUATION OF CONCRETE CYLINDER RESULTS
KM 64-315-08	CORING BRIDGE DECK OVERLAYS FOR THICKNESS
KM 64-316-08	SAMPLING PORTLAND CEMENT
KM 64-317-08	COMPRESSIVE STRENGTH OF CYLINDRICAL CONCRETE SPECIMENS USING NEOPRENE CAPS
KM 64-318-08	TEMPERATURE OF FRESHLY MIXED CONCRETE
KM 64-320-16	METHOD FOR APPROVAL OF USING SELF CONSOLIDATING CONCRETE (SCC)
KM 64-322-08	ESTIMATING CONCRETE STRENGTH BY THE MATURITY METHOD
KM 64-323-17	QUALIFICATION PROCESS FOR PRODUCERS OF READY MIX CONCRETE
KM 64-324-08	UNIT WEIGHT OF CONCRETE
KM 64-325-21	ACCEPTANCE PROCEDURES FOR FLY ASH FOR CONCRETE
KM 64-326-12	10-FOOT ROLLING STRAIGHT EDGE TEST

TABLE OF CONTENTS

ASPHALT

KM 64-401-05	CALIBRATING AND CHECKING COLD-FEED FLOW ON ASPHALT MIXING PLANTS
KM 64-404-05	SAMPLING LIQUID ASPHALT MATERIALS
KM 64-405-05	EXTRACTION OF BINDER FROM ASPHALT PAVING MIXTURES
KM 64-407-08	SIEVE ANALYSIS OF AGGREGATE FROM ASPHALT MIXING PLANTS
KM 64-409-06	COMPRESSION - DEFLECTION TEST FOR PREFORMED COMPRESSION JOINT SEALS
KM 64-411-09	PREPARING INGREDIENT MATERIALS FOR, AND PERFORMING, A LABORATORY MIX DESIGN OF AN ASPHALT MIXTURE
KM 64-415-08	NON-VOLATILE TEST FOR ASPHALT MASTIC
KM 64-416-08	PLASTIC SET TEST FOR ASPHALT MASTIC
KM 64-420-09	CORING ASPHALT PAVEMENT FOR THICKNESS
KM 64-421-22	ESTABLISHING THE JOB - MIX FORMULA OF ASPHALT MIXTURES BY THE CONTRACTOR
KM 64-422-08	ASPHALT RELEASING AGENT
KM 64-423-08	EFFECT OF WATER ON COHESION OF COMPACTED ASPHALT MIXTURES
KM 64-424-08	METHOD FOR DESIGNING OPEN-GRADED FRICTION COURSE MIXTURES
KM 64-425-05	SAMPLING ASPHALT MIXTURES
KM 64-426-15	REQUIREMENTS FOR PROCESS-CONTROL TESTING AND INSPECTION OF ASPHALT MIXTURES BY THE CONTRACTOR
KM 64-427-05	METHOD FOR DESIGNING ASPHALT MIXTURES CONTAINING RECYCLED - ASPHALT PAVEMENT (RAP)
KM 64-433-08	WET-SIEVE ANALYSIS OF AGGREGATES USED IN ASPHALT MIXTURES
KM 64-434-09	DETERMINATION OF MOISTURE CONTENT IN ASPHALT MIXTURES (RAPID FIELD TEST)
KM 64-435-05	METHOD FOR ACCEPTANCE OF ASPHALT MIXTURES BY MIXTURE PROPERTY ANALYSIS
KM 64-436-08	ASPHALT BINDER CONTENT DETERMINATION OF ASPHALT MIXTURES BY PLANT RECORDATION
KM 64-437-08	DETERMINATION OF ASPHALT BINDER CONTENT OF ASPHALT MIXTURES USING THE NUCLEAR ASPHALT CONTENT GAUGE
KM 64-438-08	ASPHALT BINDER CONTENT DETERMINATION OF ASPHALT MIXTURES BASED ON THE MAXIMUM SPECIFIC GRAVITY
KM 64-439-08	SAMPLING ASPHALT MIXTURES FROM THE PAVING SITE

TABLE OF CONTENTS

KM 64-442-09	METHOD FOR CORING AND DETERMINING PERCENT OF SOLID DENSITY OF IN-PLACE, COMPACTED, ASPHALT MIXTURE COURSES
KM 64-443-22	METHOD FOR VERIFYING A CONTRACTOR'S LABORATORY MIX DESIGN
KM 64-444-17	KYTC APPROVED SUPPLIER CERTIFICATION (ASC) PROGRAM FOR PERFORMANCE-GRADED (PG) ASPHALT BINDERS
KM 64-445-17	KYTC EMULSIFIED ASPHALTS SUPPLIER CERTIFICATION (EASC) PROGRAM
KM 64-446-08	CHEMICAL INTERACTION TESTS FOR TRAFFIC LOOP ENCAPSULANT
KM 64-447-08	CURE TEST FOR TRAFFIC LOOP ENCAPSULANT
KM 64-448-09	EVALUATION OF ASPHALT PAVEMENT WITH SUBSTANDARD PROPERTIES
KM 64-449-05	DETERMINING THE PERMEABILITY OF IN-PLACE HOT-MIX ASPHALT (HMA) USING THE AIR-INDUCED PERMEAMETER (AIP)
KM 64-450-22	DETERMINATION OF CRACKING RESISTANCE (KYCT) OF BITUMINOUS MIXTURES
KM 64-451-19	NON-TRACKING TACK APPROVAL FOR USE

GEOTECHNICAL

KM 64-501-08	DETERMINING THE CALIFORNIA BEARING RATIO OF LABORATORY COMPACTED SOILS AND SOIL - AGGREGATE MIXTURES
KM 64-502-08	CONSOLIDATED, UNDRAINED TRIAXIAL COMPRESSION TEST ON COHESIVE SOILS
KM 64-503-08	MEASUREMENT OF PORE PRESSURE IN SOILS
KM 64-511-08	MOISTURE - DENSITY RELATIONS (PROCTOR DENSITY)
KM 64-512-08	ONE POINT PROCTOR METHOD
KM 64-513-08	DETERMINATION OF SLAKE DURABILITY INDEX
KM 64-514-08	JAR SLAKE TEST
KM 64-519-08	PARTICLE SIZE ANALYSIS OF SOILS (HYDROMETER TEST)
KM 64-520-08	SUBGRADE CHEMICAL STABILIZATION TEST
KM 64-521-08	UNCONSOLIDATED, UNDRAINED COMPRESSIVE STRENGTH OF COHESIVE SOILS IN TRIAXIAL COMPRESSION
KM 64-522-08	UNCONFINED COMPRESSION TEST ON SOIL
KM 64-523-08	UNCONFINED COMPRESSION TEST ON ROCK

AGGREGATES

KM 64-601-17	SAMPLING OF AGGREGATES FOR USE AS HIGHWAY MATERIALS
--------------	---

TABLE OF CONTENTS

KM 64-604-16	DETERMINATION OF THE PERCENTAGE OF SHALE IN AGGREGATE
KM 64-605-08	SPECIFIC GRAVITY AND ABSORPTION OF FINE AGGREGATE
KM 64-606-08	PERCENTAGE OF MATERIAL FINER THAN A NO. 200 SIEVE BY USE OF A PYCNOMETER (WASH TEST)
KM 64-607-17	SPECIFIC GRAVITY AND ABSORPTION OF COARSE AGGREGATES
KM 64-608-08	AGGREGATE PRODUCER QUALITY CONTROL
KM 64-610-14	SOUNDNESS OF AGGREGATE BY USE OF SODIUM SULFATE
KM 64-615-14	DETERMINATION OF COAL AND LIGNITE IN AGGREGATES
KM 64-618-14	METALLIC IRON CONTENT IN SLAG
KM 64-620-08	WET SIEVE ANALYSIS OF FINE AND COARSE AGGREGATE
KM 64-623-14	PORE INDEX VALUE OF AGGREGATE
KM 64-626-14	RESISTANCE OF CONCRETE TO FREEZE-THAW TESTING
KM 64-627-08	PROCEDURE FOR VERIFYING OVEN TEMPERATURE
KM 64-628-08	PROCEDURE FOR VERIFYING MEASURED SIEVES
KM 64-629-14	LENGTH CHANGE OF HARDENED CONCRETE DUE TO ALKALI- CARBONATE REACTIVITY
KM 64-630-16	FLAT AND ELONGATED PARTICLES IN COARSE AGGREGATES
KM 64-631-16	PERCENTAGE OF CRUSHED PARTICLES IN COARSE AGGREGATE
KM 64-632-16	REDUCING SAMPLES OF AGGREGATE FOR TESTING PURPOSES

Kentucky Method 64-001-17
Revised 02/22/17
Supersedes KM 64-001-08
Dated 04/02/08

KENTUCKY TRANSPORTATION CABINET
QUALIFICATION PROGRAM FOR TECHNICIANS

1. SCOPE:
 - 1.1. According to Title 23, Part 637, Code of Federal Regulations (23 CFR 637), FHWA's "Quality Assurance Procedures for Construction", all acceptance and verification sampling and testing must be performed by "qualified personnel".
 - 1.2. As defined in the Quality Assurance Program for Materials Testing and Acceptance, the Kentucky Department of Highways has established a Quality Assurance (QA) program to ensure that materials and workmanship incorporated into any highway construction project are in reasonable conformity with the requirements of the approved plans and specifications, including any approved changes. This QA program allows for the use of validated, contractor-performed, quality control (QC) test results as part of an acceptance decision. It also allows for the use of test results obtained by commercial laboratories in the Independent Assurance (IA) program as well as in acceptance decisions.
2. REFERENCED DOCUMENTS: Kentucky Department of Highways Quality Assurance Program for Materials Testing and Acceptance
3. QUALIFICATION PROGRAM STEERING COMMITTEE (QPSC): The Qualification Program is overseen by a Steering Committee consisting of the following representatives:
 - State Highway Engineer
 - Deputy State Highway Engineer for Project Delivery
 - Director, Division of Construction
 - Director, Division of Materials
 - Director, Division of Employee Support
 - Division of Materials Qualification Coordinator
 - Representative, Federal Highway Administration
 - Representative, Kentucky Concrete Association (KCA)
 - Representative, Kentucky Association of Highway Contractors (KAHC)
 - Representative, Kentucky Crushed Stone Association (KCSA)
 - Representative, Plantmix Asphalt Industry of Kentucky (PAIKY)

4. QUALIFICATION POLICIES:

- 4.1. Required qualifications are primarily: 1) sample and test oriented or 2) demonstration of knowledge or expertise for a specific discipline.
 - 4.1.1. Qualifications required for sampling and testing as part of a QA program. These qualifications are required, as applicable, for the QC effort, acceptance, verification, or IAS program. To qualify, an individual must successfully perform the specific tests and necessary calculations required for each qualification type in the presence of an authorized evaluator. Successful performance is defined as demonstrating the ability to properly perform the key elements for each test method. If the individual fails to demonstrate the ability to perform a test, the individual may be allowed one retest per test method at the evaluator's discretion.
 - 4.1.2. Qualifications required for demonstration of knowledge or expertise associated with items of work. These qualifications are required, as applicable, for project oversight when specific items of work are being performed.
- 4.2. The individual must pass a written examination administered by an authorized evaluator. An individual failing the written examination may request a retest. The individual may be allowed one retest at the evaluator's discretion. The retest must be requested, scheduled and administered within 30 days of the notification of failure. Failure to pass the second written examination shall be considered as failing the entire qualification.
- 4.3. Qualification of an individual is valid for not more than five years. After that time, the individual must qualify again. Under the requirements of the QA program, interim evaluations will be permitted when appropriately justified.
- 4.4. Test questions and other examination data used to administer this qualification program are subject to reuse and are considered confidential and exempt from public records inspection.

5. EXAMINATION METHODS AND POLICIES:

- 5.1. A standard set of examinations for each qualification will be used statewide. With the exception of national qualifications, the examinations will be developed by a committee composed of personnel from some or all of the following: Division of Materials, Division of Construction, and appropriate industry representatives.
- 5.2. In addition, the individual may be required to participate in proficiency sample testing administered by the qualification authority to validate the qualification. The result of the proficiency samples will be evaluated for compliance with acceptable tolerance limits. If the comparison of test results does not comply with the tolerances, an engineering review of the test procedures and equipment shall be performed immediately to determine the source of the discrepancy. Corrective actions must be identified, and incorporated as appropriate, prior to the individual performing additional testing on that test method.

6. **DISQUALIFICATION PROCEDURES:** A qualified individual can be disqualified for any of the following reasons:
- 6.1. Failure to pass requalification requirements and/or provide payment of fees, initial or requalification.
 - 6.2. Found to be guilty of falsifying test results, records, and/or reports or any willful departure from approved policy/procedure. Allegations of falsification or willful departure will be made to the QPSC in writing. The allegations will contain the name, address, and signature of the individual(s) making the allegation. The allegations will be investigated by the QPSC. The accused and the individual(s) making the allegation will be given the opportunity to appear before the QPSC. All involved parties will be notified in writing of the findings by the QPSC. Any warranted actions will be imposed according to the guidance contained herein. Decisions regarding allegations may be appealed in writing to the QPSC which will consider such written appeals and take such action considered appropriate.
 - 6.2.1. First offense would result in a 12-month revocation of qualification status in all qualification types. Prior to reinstatement, the individual shall again successfully complete qualification classes.
 - 6.2.2. Second offense would result in a permanent loss of qualification status in all qualification types.
 - 6.3. Found to be guilty of improperly performing tests, failing to perform tests, or being incapable of performing tests and documented by a qualified technician. The documentation ("Report of Violation" form, copy attached) must include the date(s), time(s), location(s), occurrence(s) of non-conformance, and signature of the qualified technician reporting the incident.
 - 6.3.1. First offense would result in a letter of reprimand from the QPSC.
 - 6.3.2. Second offense would result in a 30-day revocation of qualification status.
 - 6.3.3. Third offense would result in a revocation of qualification status. The individual may obtain qualification again after a six-month period and successfully completing the appropriate qualification class(es).

APPROVED

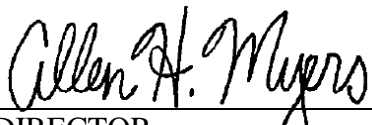

 DIRECTOR
 DIVISION OF MATERIALS

DATE

_____ 02/22/17 _____

Kentucky Method 64-001-17
 Revised 02/22/17
 Supersedes KM 64-001-08
 Dated 04/02/08

**KENTUCKY QUALIFICATION PROGRAM FOR TECHNICIANS
REPORT OF VIOLATION**

The undersigned Kentucky Qualified Technician has witnessed and documented violation(s) of the Technician Qualification Program. These violations are outlined in Section 7 of KM 64-001, Kentucky Transportation Cabinet Qualification Program for Technicians. The qualified technician noted in violation is:

Name

Certification No.

Date(s) of Violation

Time(s) of Violation

Location(s) of Violation

Description of the violation (Attach additional sheets if necessary):

Qualified Technician

Inspector ID Number

Date

Signature

NUCLEAR GAUGES USED FOR DENSITY OF VARIOUS MATERIALS

1. SCOPE: This method is used to determine the in-place density of various materials using the backscatter or direct transmission method. This procedure supplements the manufacturer's instruction manual by outlining procedures for density testing.
2. APPARATUS:
 - 2.1. Nuclear density gauge: An instrument containing two radioactive sources, combined with density and moisture detectors and other basic components, housed in a single unit for the backscatter method or direct transmission. The devices considered in this method are Troxler Model 3411B, Troxler Model 3430, Troxler 3440 and Humbolt 5001EZ.
 - 2.2. A portable reference block: This block is used to establish standard counts and as a repeatable reference for verifying stability of the gauge.
 - 2.3. AC charger for office charging and a DC charger for charging from a cigarette lighter in vehicle for emergency field use. Humbolts do not have chargers.
 - 2.4. Drill rod with puller: Used with a hammer to create the hole required for direct transmission measurements.
 - 2.5. Scraper plate: Functions as a guide for the drill rod and for test-site surface preparation.
 - 2.6. 4-lb. Hammer: To drive the drill rod.
3. CALIBRATION PROCEDURE (Daily Standard Count):
 - 3.1. Perform all calibration requirements daily, or more frequently if transportation, background, or other conditions necessitate. The importance of obtaining a set of accurate standard counts cannot be over-emphasized. The accuracy of measurements made with this instrument is directly related to the accuracy of the standard counts. Refer to the manufacturer's instruction manual for calibration procedures.
 - 3.2. Turn-On/Warm-Up:
 - 3.2.1. Model 3411B: Place the gauge on the reference block. Turn the "PWR/TIME" switch to the "SLOW" position, and allow the gauge to warm up for at least 10 minutes before calibration.
 - 3.2.2. Model 3430: Place the gauge on the reference block. Press the "ON" switch. The gauge will undergo a 300-second self-test. After the self-test is complete, the gauge is ready for calibration.

- 3.2.3. Model 3440: Place the gauge on the reference block. Press the “ON” switch. The gauge will undergo a 300-second self-test. After the self-test is complete, the gauge is ready for calibration.
- 3.2.4. Humboldt 5001EZ: Place the gauge on reference block. Press “PWR” switch. The gauge will undergo a series of self-test routines. After the self-test is complete, the gauge is ready for calibration.
- 3.3. With all models, the source rod is located on the block opposite the metal plate. Ensure the gauge base makes firm contact with the surface of the reference block and is flush against the metal plate.
- 3.4. Remove the lock from the trigger, and ensure the handle is indexed in the standard or safe position.
- 3.5. Obtain the standard counts as follows:
 - 3.5.1. Model 3411B:
 - 3.5.1.1. Press the “SHIFT” key, and while holding it down, press and release the “STANDARD/MEASURE” key.
 - 3.5.1.2. Release the “SHIFT” key. For 4 minutes the density count will accumulate. Notice “ERR” message in upper left-hand corner.
 - 3.5.2. Model 3430:
 - 3.5.2.1. Press the “STD” key. The gauge will display the last standard counts accumulated along with “new std cnt?”
 - 3.5.2.2. Press the “ON/YES” key.
 - 3.5.2.3. Press the “START” key.
 - 3.5.2.4. The count time will start, with the time remaining displayed in seconds, beginning at 240 seconds.
 - 3.5.3. Model 3440:
 - 3.5.3.1. Press the “STD” key. The gauge will display the last standard counts accumulated along with “new std cnt?”
 - 3.5.3.2. Press the “ON/YES” key.
 - 3.5.3.3. Press the “START” key.
 - 3.5.3.4. The count time will start, with the time remaining displayed in seconds, beginning at 240 seconds.

3.5.4. Humboldt 5001EZ:

3.5.4.1. Press the “STD/STAT” key. The gauge will display the last standard counts accumulated along with date and time.

3.5.4.2. Press the F3.

3.5.4.3. The count time will start. After the density and moisture standard will be stored in the registers.

3.6. After obtaining the standard counts, record the counts in the logbook supplied with the gauge.

3.6.1. Model 3411B:

3.6.1.1. Return the source rod to the safe position before viewing the data.

3.6.1.2. The gauge will display the density standard (DS) count after the completion of the count. To obtain the moisture standard (MS) count, press the “MS” key.

3.6.1.3. View the density standard count again by pressing the “DS” key, if necessary. View the counts anytime by pressing the “DS” and “MS” keys. These counts remain in the gauge until it is turned off.

3.6.2. Model 3430: After the standard count is complete, scroll through the menu to display the “DS” and “MS.” These counts remain in the gauge until another standard count is taken, regardless of whether or not the gauge is turned off.

3.6.3. Model 3440: After the standard count is complete, scroll through the menu to display the “DS” and “MS”. These counts remain in the gauge until another standard count is taken, regardless of whether or not the gauge is turned off.

3.6.4. Humboldt 5001EZ: After the standard count is complete and there are no errors in the standard count, the display will show the “DS” and “MS”.

3.7. In general, a sudden shift of more than one percent in the density standard count, or two percent in the moisture standard count, as compared to the average of the previous four sets, would indicate some abnormality in gauge operation or procedure. In this case, repeat the calibration procedure. If problems persist, contact the central office radiation safety officer (RSO).

4. OPERATING THE GAUGE: Use the manufacturer’s instruction manual when operating the Troxler or Humboldt gauges. Note: Time settings for a recorded test shall be Normal (1 minute) or Slow (4 minutes).

4.1. Place the gauge on as smooth a surface as possible (concrete, aggregate, or compacted soil). Depress the handle trigger, and move the rod to the backscatter position. Be certain that the handle clicks into the slot on the index rod. Determine this position by pulling up

and down on the handle without depressing the.

4.2. Density and Moisture Determinations:

4.2.1. Model 3411B:

- 4.2.1.1. Set the “PWR/TIME” switch on “NORM (one minute count),” and press the “START” key. Note that “ERR” appears in the display.
- 4.2.1.2. At the end of the “NORM” time period, “ERR” will disappear. The test is now complete. Return the source rod to the safe position before viewing the data. Read the density count and moisture count by pressing the “DC” and “MC” keys, respectively.

4.2.2. Model 3430:

- 4.2.2.1. Press the “TIME” key.
- 4.2.2.2. Press the “up arrow” or the “down arrow” until the gauge displays “1 min.”
- 4.2.2.3. Press the “ENTER” key.
- 4.2.2.4. Press the “START” key. The gauge will then accumulate counts for one minute, displaying the count time in seconds. The gauge will display a density, moisture, or count value when the count is complete. Return the source rod to the safe position. View all test data by scrolling through the data with the “up arrow” or the “down arrow” on the keyboard.

4.2.3. Model 3440:

- 4.2.3.1. Press the “TIME” key.
- 4.2.3.2. Press the “up arrow” or the “down arrow” until the gauge displays “1 min.”
- 4.2.3.3. Press the “ENTER” key.
- 4.2.3.4. Press the “START” key. The gauge will then accumulate counts for one minute, displaying the count time in seconds. The gauge will display density, moisture, or count value when the count is complete. Return the source rod to the safe position. View all test data by scrolling through the data with the “up arrow” or the “down arrow” on the keyboard.

4.2.4. Humboldt 5001EZ:

- 4.2.4.1. Press the “MEAS” key.

KM 64-002-08

4.2.4.2. The gauge will then accumulate counts for one minute. The gauge will display density and moisture when the count is complete. Return the source rod to the safe position.

- 4.3. The moisture and density backscatter measurement is now complete. If testing soil or aggregate base, another option is a moisture and density direct transmission measurement obtained by punching a hole using the drill rod, guide, and a hammer. Insert the source rod into the prepared hole to the proper depth. The hole for the source rod should always be at least two inches deeper than the depth of measurement. Proceed as directed by Instruction Manual. Remember to set the “DEPTH” switch to the appropriate depth.
- 4.4. The gauge displays computed results in pounds per cubic foot (PCF). The data may now be processed to obtain the desired parameter, provided both the test depth and target density have been entered.
- 4.5. Set the “DEPTH” switch on “BS” (backscatter) and the “MOISTURE CORRECTION” on “+00.” Press the “WD” key, and the value of the wet density will appear in the display. Press the “DD” key, and the value of the dry density will appear. Repeat for “M” (moisture content) and “%M” (percent of moisture). When obtaining the moisture measurement on concrete, this value will be the water equivalency of the hydration of the concrete.
- 4.6. To control the top yellow row of keys press and hold the “SHIFT” key. For instance, for “% of Proctor” press and hold the “SHIFT” key and press the “% PR” key.
- 4.7. The value “z” is a user-defined value for target density. Knowing the correct proctor density for the material that is being tested is critical. Ensure that the proctor density is set in the density gauge. Refer to Model’s Manufacturer Instruction Manual.

5. TEST SITE:

- 5.1. Determine test sites in accordance with [Kentucky Method \(KM\) 64-113, *Sampling Materials by Random Number Sampling*](#), for acceptance purposes. For control strip qualification or other informational testing, the Kentucky Transportation Cabinet (KYTC) may select test sites without utilizing KM 64-113.
- 5.2. In order to obtain optimum accuracy from the gauge, perform site preparation. The method for site preparation varies, depending on the surface and the type of test performed.

6. DIRECT TRANSMISSION PROCEDURE (FOR SOILS):

- 6.1. Using the scraper plate supplied with the gauge, carefully scrape the surface to a smooth condition, removing all dried and loose material. If the scraping action dislodges surface material, remove it; fill the voids with fine material, and lightly tamp the surface.
- 6.2. Place the scraper plate in the middle of the site, and drive the drill rod into the soil using a 4-lb. hammer. Placing one foot on the plate will prevent it from slipping or otherwise damaging the site by allowing the drill rod to move from side to side. Ensure that the rod has been driven 2” deeper than the test depth.

- 6.3. Utilize the drill rod puller for extraction of the drill rod. Place the puller on the drill rod before driving. With one foot remaining on the scraper plate, rotate the drill rod to loosen it, and then remove it up and out of the hole. Ensure no damage to the hole occurs.
- 6.4. Place the gauge over the site so that the source rod aligns with the hole. Depress the trigger, and push the source rod down to the properly indexed position at the desired depth. With the operator facing the scaler module, pull the gauge toward the operator to seat the source rod against the side of the hole. Perform the test at a 6-in. depth.
 - 6.4.1. Model 3411B: the depth selection switch is graduated from “BS” (backscatter) through 12 in. Dial in the appropriate depth with the switch. Gauges are calibrated on 2-in. increments only.
 - 6.4.2. Model 3430: press the “DEPTH” key. Select the correct depth with the “up arrow” or the “down arrow.” When the correct depth is displayed, press the “START/ENTER” key.
 - 6.4.3. Model 3440: press the “DEPTH” key. Select the correct depth with the “up arrow” or the “down arrow.” When the correct depth is displayed, press the “START/ENTER” key.
 - 6.4.4. Humboldt 500EZ: Press the F3 to increase or F4 to decrease the value. When the correct depth is displayed, press the “MEAS” key.

7. BACKSCATTER PROCEDURE (FOR AGGREGATE BASE AND CONCRETE):

- 7.1. Situations may occur in which it is impossible to drive the drill rod into the material without destroying the surface. In this case, use the backscatter procedure.
- 7.2. Under backscatter conditions, site preparation must be more thorough and all voids filled as closely as possible to the same, or similar, density as the compacted material. The gauge must not rock on its base when seated.
- 7.3. When the source rod is indexed into the backscatter position, be careful not to bypass the intended index notch and force the source rod tip on, or into, the material.
- 7.4. Soils and aggregate compaction are based on a dry density; concrete compaction is based on a wet density. Record only the wet density measurement on concrete.
 - 7.4.1. Model 3411B: refer to the manufacturer’s instruction manual.
 - 7.4.2. Model 3430: refer to the manufacturer’s instruction manual.
 - 7.4.3. Model 3440: refer to the manufacturer’s instruction manual.
 - 7.4.4. Humboldt 5001EZ: refer to the manufacturer’s instruction manual.

8. REPORTING:

- 8.1. Record the station number and transverse location of each test location.
- 8.2. Report the density results on the applicable SiteManager Nuclear Density Excel Spreadsheet (DENSACPT.XLS or DENSITY.XLS).

9. PRECAUTIONS:

- 9.1. Ensure all personnel operating nuclear gauges are trained in the principles of nuclear testing and all related safety practices. Operators shall wear personnel monitoring devices such as badges.
- 9.2. Ensure all nuclear gauge users refer to, and observe, the safety precautions in the Division of Construction's Guidance Manual and Manufacturer's Operational Manual for Nuclear Gauges.
- 9.3. Perform all tests at least 30 ft. from other radioactive material.
- 9.4. Perform all tests at least two feet from any vertical projections (retaining walls, ditches, etc.) and at least three inches from the pavement edge or joint.
- 9.5. Keep all personnel without monitoring devices at least 15' from the nuclear gauge.

APPROVED

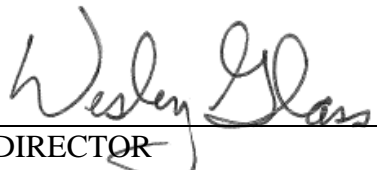

DIRECTOR
DIVISION OF MATERIALS

DATE

02/29/08

Kentucky Method 64-002-08
Revised 02/29/08
Supersedes KM 64-002-03
Dated 02/04/03

APPROVAL OF NEW MATERIALS TO BE USED ON
TRANSPORTATION PROJECTS IN KENTUCKY

1. SCOPE:

- 1.1 With advances in technology comes the arrival of new and innovative products to be used in transportation projects. The Kentucky Transportation Cabinet (KYTC) receives numerous requests for the use of new materials or materials that have been improved or modified.
- 1.2 New products may not meet current specifications or may not have specifications approved by KYTC. If there is not a central approval process for new or modified materials, there is the potential for inferior or potentially dangerous products to be used on Kentucky's highways.
- 1.3 The New Product Review Committee (NPRC) has the duty to review new products to ensure that they are safe, durable and economical for the citizens of the Commonwealth. The NPRC decides what products are approved for use on Kentucky highways but does not make a recommendation that any particular product be used over another competing product.

2. COMMITTEE: The NPRC will be composed of:

Voting members:

Executive Director, Office of Project Delivery & Preservation
Executive Director, Office of Project Development
Director, Division of Construction
Director, Division of Maintenance
Director, Division of Traffic Operations
Director, Division of Materials
Director, Division of Structural Design
Director, Division of Highway Design

Non-Voting Members:

KyPEL Administrator and Chairman of Committee
Representative of Kentucky Association of Highway Contractors
Representative of Plantmix Asphalt Industry of Kentucky
Representative of Kentucky Concrete Pavement Association
Representative of Kentucky Transportation Center

3. PRODUCTS REVIEWED BY THE COMMITTEE :

Any product that is new to the market or a product that has been substantially modified should be reviewed by the New Product Review Committee if it is to be used in the construction or maintenance of Kentucky highways. Products such as reflectors, barriers, asphalt additives, and concrete patching materials will come before the committee if they are not already approved for highway construction and maintenance. Items that are strictly used as equipment for construction or maintenance will not go before the committee.

4. PROCESS:

4.1 The approval process is broken into phases that allow for a product to advance to approval and placement on the List of Approved Materials. The progress of a product is tracked with the Kentucky Product Evaluation List (KyPEL). KyPEL is an online application process that allows the manufacturer or vendor to see the progress of a product or to see comments about the product. The manufacturer or vendor can then update attachments, submit samples of the product, or make clarifications.

4.2 KyPEL is handled by an administrator who has the responsibility of ensuring that products are evaluated fairly and consistently. The administrator assigns a product to a particular phase based on a set of guidelines. It is also the responsibility of the administrator to disseminate information to all parties that must make recommendations concerning products. The administrator must track assignments to ensure that the products do not languish in any one phase for too long.

4.3 The process begins when a manufacturer or vendor accesses KyPEL via the internet at: <http://www.ktc.uky.edu/kytc/kypel/login.php>. The administrator reviews the information that is submitted and follows the guidelines in assigning phases.

4.4 Phases:

4.4.1 Phase I- Product has been submitted and is pending initial review.

During Phase I, it is the responsibility of the administrator to ensure that there is enough information about the product for an initial review to be conducted. Vendors and manufacturers will have up to three months to submit the necessary information to enter into Phase II. If at the end of the second month there is no information on a product to review, the administrator will attempt to make contact with the person responsible for the submittal. If after three months there is no further information to review, the administrator will place the product in Phase XIII.

- 4.4.2 Phase II- The product is under preliminary review by appropriate section(s)/division(s) and awaiting recommendation(s) to the chair from the appropriate section(s)/division(s). Minimal study of available literature is necessary at this stage.

Phase II is begun with the administrator assigning the product to the appropriate section(s)/division(s). The personnel responsible for reviewing the information are to determine if the product falls under a current specification or if specifications do not exist. The appropriate personnel make a recommendation to the committee based on the initial information that has been provided. Personnel are to ensure that their comments are strictly based on whether there is potential for the product to be used in a KYTC project. The administrator must review the comments from the assigned personnel. If the product is not covered under an existing specification, then the administrator assigns the product to Phase III and sends the information to the committee members. If the product falls under existing specifications, then the product is placed in Phase VI.

- 4.4.3 Phase III- Product is under detailed laboratory and/ or literature review by the NPRC.

The administrator receives all comments and recommendations from committee members. If the majority of the committee members decide that a product has potential to be used in KYTC projects, then the material is assigned to Phase IV. If the committee determines that the product is already covered by another specification or does not need to be approved, then the product is assigned to either Phase VI or Phase VIII. If the committee determines that the product does not have the potential to be used in KYTC projects, then the product is not approved and placed into Phase XIII. Committee members will be given 14 days to vote on the product. If the committee feels that additional information is needed, the administrator will make contact with the manufacturer to obtain the necessary information.

- 4.4.4 Phase IV- Product has been approved for experimental use by the New Product Review Committee. The product may be used on a limited basis; however, change orders must be submitted and approved prior to use of the product. The product will be monitored for performance for two years, but the performance period may be changed depending on the type of product and susceptibility to weathering. If the product performs poorly and poses a safety risk, the product may be removed before scheduled replacement.

When a product is entered into Phase IV the product may be used in a construction or maintenance project provided it has been approved prior to use. It is up to the

product manufacturer/ vendor to approach the contractor about using the product. A change order will have to be approved and the administrator must be notified prior to installation. It may be necessary for the administrator and a representative of the manufacturer or vendor to be present during installation. The administrator will attempt to inspect the product periodically to ensure that the product is performing satisfactorily and is not posing a safety risk. At the end of Phase IV, the New Product Review Committee will review the performance of the product. If a product has been in Phase IV for two years and has not been used on a project, then the administrator will take the product back to the committee to determine if the phase should continue or if the evaluation should be terminated.

- 4.4.5 Phase V- The product has been approved for use by the New Products Review Committee. The contractor must have the product approved by the KYTC and the Federal Highway Administration (FHWA) (if applicable) prior to use of the product on a project. Standard Specifications or Special Notes are being developed for this type of material/product.

Prior to entering Phase V, a product has been tested experimentally and the results of the experimental usage have been reviewed by the NPRC. The Committee has approved the product for use on Kentucky highways. The administrator is working with others within KYTC to develop Standard Specifications or Special Notes.

- 4.4.6 Phase VI- Current specifications exist for this type of product. The manufacturer must submit samples and/ or provide required information to have the product approved and placed on the List of Approved Materials (if applicable).

Products that are placed in Phase VI typically will not have been reviewed by the committee. Products that are in Phase VI already have specifications and will be tested to determine if they meet the existing specifications. If the product meets the specifications then it can be placed on the List of Approved Materials.

- 4.4.7 Phase VII- Reserved

- 4.4.8 Phase VIII- Not a product to be evaluated by the New Products Review Committee.

If the product is not to be utilized in highway and bridge construction or maintenance then it does not fall under the review of the committee. If the product is considered to be equipment that will be used in the construction or maintenance of highways or bridges it will not be reviewed by the committee.

- 4.4.9 Phase IX- Reserved

4.4.10 Phase X- Product has been approved and special notes or specifications exist.

4.4.11 Phase XI- Reserved

4.4.12 Phase XII- Reserved

4.4.13 Phase XIII A-G Product not approved for use in Kentucky highway or bridge construction.

5. IMMEDIATE NEED:

If a product is in immediate need, the contractor and/or the KYTC office responsible for installation or use should notify the KyPEL administrator of the need. The request can be submitted by email, fax, or letter. The KyPEL administrator will notify the members of the committee of the urgent need. The product can be approved for a conditional Phase IV if two or more voting committee members agree that the product is needed immediately. The committee will review the product within six months of installation to determine if the product should remain in Phase IV. The product cannot be approved for phases V, VI, X, or XIII until it has been reviewed and approved by the full committee. If the product is not used within three months of the request then the NPRC will decide if the product should remain in Phase IV or be placed into another phase.

APPROVED



EXECUTIVE DIRECTOR
OFFICE OF PROJECT DELIVERY
& PRESERVATION

DATE

03/18/10

Kentucky Method 64-003-10

Dated 03/18/10

TESTING AND ACCEPTANCE OF STEEL REINFORCING BARS (UNCOATED AND COATED)

1. SCOPE:

- 1.1. The Kentucky Transportation Cabinet's (KYTC) acceptance procedure for plain (uncoated) steel reinforcing bars requires product participation in the National Transportation Product Evaluation Program (NTPEP) for Reinforcing Steel. Product acceptance may only occur if manufacturers are included on the Division of Material's (Division) current [List of Approved Materials \(LAM\)](#).

The KYTC's acceptance procedures for epoxy coated steel reinforcing bars requires certification of all bars prior to coating. The epoxy coating shall be applied only by epoxy coaters included on the LAM.

- 1.2. Whoever supplies reinforcing steel to a KYTC project, whether the manufacturer, coater, or fabricator, must provide proper documentation. This shall consist of at a minimum 1) TC 64-122 for each shipment, 2) certified mill test reports for each heat, 3) certifications from the steel and powder manufacturers and from the coater. Certifications shall include a statement of compliance with the applicable specifications and shall be dated and signed by a responsible party.

2. MANUFACTURER'S RESPONSIBILITIES:

- 2.1. Gaining LAM Status: Reinforcing steel manufacturers desiring to be included on the LAM shall adhere to NTPEP requirements and maintain their approved status with KYTC.

- 2.1.1. A certified mill test shall be furnished with each shipment of steel. The certified mill test shall contain the results of all applicable ASTM tests on a per heat basis: that is; nominal weight, yield and tensile strengths, elongation, 180° bend test, height of deformations and phosphorous content.

- 2.1.2. Reinforcing steel shipped directly to the jobsite by the manufacturer shall meet the requirements outlined by NTPEP.

- 2.2. Heat Identification Requirements: The fabricator or manufacturer shall provide a definite means whereby the various heat numbers in each shipment can be positively identified and, if necessary, separated from the remainder of the shipment. Individual bundles of bars shall be identified by tags or other acceptable means and tied into sub-bundles as necessary to provide positive heat identification.

- 2.3. Testing And Acceptance Criteria:

2.3.1. General:

2.3.1.1. All testing shall be performed as stipulated in the NTPEP reinforcing steel program.

2.3.1.2. The failure of any property of any test specimen shall be cause for rejection of the heat. Verification of failing results may be performed provided additional material from the same heat remains. The resampling shall consists of three bars from the heat in question.

2.4. Removal From LAM: Maintaining LAM status will be contingent upon compliance with all requirements contained in this section and section 5.

3. FABRICATOR'S RESPONSIBILITIES:

3.1. Gaining LAM Status: Fabricators desiring to be included on the LAM shall abide by all applicable requirements listed herein.

3.1.1. Purchase reinforcing steel from a manufacturer or epoxy coater on the LAM maintained by the Division.

3.1.2. Identity of heats shall be maintained at all times and documentation shall be provided as required in [section 2.2](#). Coated reinforcing steel shall also be accompanied by copies of all documentation provided by the coater.

3.2. Removal From LAM: Maintaining LAM status will be contingent upon compliance with all requirements contained in this section and [section 5](#).

4. COATER'S RESPONSIBILITIES:

4.1. Gaining LAM Status: Epoxy coaters desiring to be included on the LAM shall abide by all requirements listed herein. The coater must agree to abide by the current edition of [Kentucky Standard Specifications for Road and Bridge Construction](#) (Specifications) (specifically section 811.10) and submit and obtain approval of its Quality Control Program from the Division. For the Quality Control Program to be acceptable, the coater must, as a minimum, comply with the following:

4.1.1. All reinforcing steel for coating shall be from a manufacturer on the LAM maintained by the Division.

4.1.2. Identity of heats shall be maintained at all times as required in [section 2.2](#).

4.1.3. Use only epoxy powder shown on the LAM. A written manufacturer's certification for this resin shall be submitted annually to the Division.

4.1.4. Perform the following quality functions (KM 64-102) and record test results:

- 4.1.4.1. Monitor blast cleaning operations at least every two hours to insure conformance to pictorial standards A Sp 10, B Sp 10, or C Sp 10 of SSPC Vis 1 and to maintain proper etch pattern.
- 4.1.4.2. Insure that bars are coated within 8 hours after blast cleaning.
- 4.1.4.3. Check temperature of bar just prior to coating to insure powder manufacturer's application temperature is met.
- 4.1.4.4. Check daily to insure that the minimum curing time recommended by the powder manufacturer has elapsed prior to the coated bars reaching the water bath.
- 4.1.4.5. Check the coating thickness with a thumb wheel pulloff gauge. The thickness gauge will be calibrated for accuracy at least daily and the results recorded on the quality control report. The thickness will be measured according to ASTM A 775. The coating thickness shall be 7 to 12 mils inclusive. Thickness measurements will be taken as often as necessary, but at least one bar from each 60 minutes of production time shall be documented. If the coating on the bar checked does not meet the thickness requirements, that bar shall be rejected and additional bars (usually adjacent to the original test bar) shall be checked to determine the extent of the problem. Either an insufficient or excessive film thickness will be cause for rejection of the coated bars.
- 4.1.4.6. Check for Continuity of Coating:
 - 4.1.4.6.1. An operational in-line 67.5-V, 80,000 ohms wet-sponge type direct-current holiday (defect) detector with an automated holiday counter shall be provided for each strand of the production line. In-line and hand-held holiday detectors shall be operated and maintained in accordance with the manufacturer's instructions.
 - 4.1.4.6.2. Compare the accuracy of the in-line holiday detector with a hand-held holiday detector at least once a production shift. Holiday counts from both the hand-held and in-line holiday detectors shall be recorded on the inspection form.
 - 4.1.4.6.3. When any bar has more than two holidays per linear foot or a total defective area exceeding 0.25 percent of the surface area per linear foot, the holidays shall be repaired with approved touch-up material. When any bar has more than

five holidays per linear foot or a total defective area exceeding 0.5 percent of the surface area per linear foot, the bar shall be rejected. When any bar is found that requires touch-up or rejection, additional bars (usually adjacent to the problem bar) shall be checked to determine the extent of the problem.

4.1.4.7. Check the flexibility of the coating by bending one bar of each size coated per shift, but with a minimum of two tests per eight hour shift. The bars are to be bent around a pin equal in diameter to the bar size in inches as per ASTM A 775 Table I. Bend the bar at room temperature through an arc of 180° after rebound. The coating should not show any visible cracks.

4.1.5. Submit CRSI (Concrete Reinforced Steel Institute) ECR Plant Certification, the latest audit results and any response to CRSI.

4.2. Removal From LAM: Maintaining LAM status will be contingent upon compliance with all requirements contained in this section and section 5.

5. CONDITIONS FOR REMOVAL FROM LAM:

5.1. The following conditions will result in probation or removal from the LAM:

5.1.1. Failure to comply with the minimum criteria for each approved list.

5.1.2. Frequently recurring instances of check sample failure.

5.1.3. Inclusion of unapproved heats or grades in shipments.

5.1.4. Lack of sufficient heat identification.

5.1.5. Furnishing of non-specification material.

5.1.6. Failure to maintain participation in NTPEP

5.2. Once a manufacturer, fabricator or coater is removed from an approved list, reinstatement may be requested after a period of three months, providing the reason(s) for removal is (are) recognized and corrected.

APPROVED

Allen H. Myers

DIRECTOR
DIVISION OF
MATERIALS

DATE

01/07/19

Kentucky Method 64-101-19

Revised 01/07/19

Supersedes 64-101-08

Dated 05/19/08

Attachments

**FABRICATOR'S HEAT NUMBER IDENTIFICATION OF REINFORCING BARS****SECTION 1: PROJECT INFORMATION**

COUNTY	PROJECT NO.
MANUFACTURER	FABRICATOR
BAR LIST NUMBER(S)	CONTRACTOR
DRAWING NO.	STATION

SECTION 2: HEAT NUMBER & IDENTIFICATION *(The following table itemizes heat number and heat number identification such that each heat number involved may be positively identified and separated, if necessary, at destination.)*

BAR LIST OR ORDER NO.	BAR TYPE PLAIN OR EPOXY	MANUFACTURE (MILL MARK)	BAR SIZE	GRADE	WEIGHT (LBS.)	HEAT NO.

SECTION 3: CERTIFICATION

I certify that all the heats listed above and contained in this shipment meet the requirements of the current Kentucky Method 64-101 and Kentucky Standard Specifications Section 811.02. Manufacturer's certified test results have been furnished to the Division of Materials.

SIGNATURE/AUTHORIZED REPRESENTATIVE	DATE
--	-------------

QUALITY CONTROL REPORT

(COMPANY NAME)

I GENERAL INFORMATION -

COUNTY _____ PROJECT _____
Epoxy Lot No. _____ Date _____
Type Epoxy Used _____ Mfg.'s Cert. of Epoxy Powder _____
Bar Size(s) _____ Pretested Heat No.(s) _____
Rebar Supplier _____ Fabricator _____

II REQUIREMENTS PRIOR AND DURING APPLICATION OF COATING -

Blast Cleaned to Conform to pictorial standards A Sp 10, B Sp 10, or C Sp 10 of
SSPC Vis 1 _____
Bars coated within 8 hours of blast cleaning _____
Bars at epoxy manufacturer's recommended temperature _____ °C (°F.) to _____ °C (°F.)
1) _____ °C (°F.) 2) _____ °C (°F.) 3) _____ °C (°F.)
Curing time from leaving coating chamber until arrival at water bath _____ seconds

III REQUIRED PROPERTIES OF COATED BARS -

Thickness gauge calibration standard _____ mils. Today's reading _____ mil
Coating thickness, one sample from each 30 minutes of production time will be tested, 7 to 12 mil.
Work sheet on page 2 _____

Check coated bars for no contamination, free from holes, cracks, and damaged areas. One bar will be tested from each 30 minutes of production time with a visual scanning of the other bars.

Holidays, maximum of two per 2 per foot, one sample from each 30 minutes of production time shall be tested.
Work sheet on page 2 _____

Bend test will be taken on one bar of each size per 8 hour shift, but with a minimum of two. Bend 120° around required pin 20°C (68°) - 29.4°C (85°F) 1) _____ 2) _____

IV GENERAL REQUIREMENTS AFTER COATING -

All damaged areas repaired within 24 hours _____
Bundles of coated bars tied with protective materials _____
Bundles loaded on trucks with caution and protective dunnage _____

Inspectors Signature

Kentucky Method 64-102-08
Revised 02/20/08
Supersedes KM 64-102-05
Dated 01/04/05

TEST PROCEDURES FOR THE PLANT INSPECTION OF EPOXY COATED STEEL REINFORCEMENT

- I. SCOPE: This method contains procedures for conducting the various tests that are performed during the in-plant inspection of epoxy coated steel reinforcement (deformed and plain bars.)
2. CLEANLINESS OF BARS:
 - 2.1. Apparatus: Pictorial standards A Sp 10, B Sp 10, or C Sp 10 from the Steel Structures Painting Preparation Specification SSPC-SP10.
 - 2.2. Frequency: Every 4 hours minimum.
 - 2.3. Procedure: Compare the color of the surface of the steel bars to either of the pictorial standards.
 - 2.4. Remarks: The cleaned surface shall correspond with either of the pictorial standards, otherwise recleaning will be required. In addition, the surfaces shall be free of all dust and grit.
3. PREHEAT BAR TEMPERATURE:
 - 3.1. Apparatus: Tempilstiks corresponding to the upper and lower temperature of the manufacturer's recommended coating range.
 - 3.2. Frequency: Each time the coating process is started after a delay or shutdown of more than 10 minutes, and any other time deemed necessary.
 - 3.3. Procedure: Touch the tempilstik representing the lower end of the manufacturer's coating range to the bar just prior to its entering the coating chamber; the tempilstik should melt. Touch the tempilstik representing the upper end of the manufacturer's coating range to the bar just prior to its entering the coating chamber; it should not melt.
 - 3.4. Remarks: The bars shall be preheated so that the bar temperature at the entrance to the coating chamber is within the range recommended by the manufacturer of the powdered epoxy resin.
4. COATING THICKNESS:
 - 4.1. Apparatus: The coating thickness will be determined with an instrument conforming to the requirements of ASTM G 12.
 - 4.2. Frequency: Thickness determinations will be made as often as deemed necessary, but at

least one bar from each 60 minutes of production time shall be documented.

- 4.3. Procedures: Calibrate the coating thickness instrument on test blocks or plastic strips that have been previously verified as to thickness. The thickness will be measured according to ASTM A 775 with the following exception: instead of a minimum of five recorded measurements on each side of the bar, a minimum of three recorded measurements will be taken on each side of the bar (a measurement is the average of three individual readings obtained between three consecutive deformations).
- 4.4. Remarks: Either an insufficient or excessive film thickness will be cause for rejection of the coated bars.

5. CONTINUITY OF COATING:

- 5.1. Apparatus: A 67 1/2 volt detector such as the Arct T. Flower Co. No. 806 or the Tinker Razor Co. Model M-1.
- 5.2. Frequency: After curing, all bars shall be checked visually for defects in the coating such as holes, voids, delaminations, contamination and damaged areas. In addition, the entire length of at least one bar once per shift will be checked for "holidays" (pinholes not visually discernible).
- 5.3. Procedure: Wet the sponge until it is damp, but not dripping wet. Connect the wire lead to an uncoated spot on the bar and then move the sponge up and down the bar from one end to the other. The holiday detector will beep when a holiday or bare area is touched.
- 5.4. Remarks: When any bar has more than 2 defects and/or "holidays" per linear foot or a total defective area exceeding 0.25% of the surface area per linear foot, the holidays and/or defects shall be repaired with the touch-up material. When any bar has more than 5 defects and/or holidays per linear foot or a total defective area exceeding 0.5% of the surface area per linear foot, the bar shall be rejected.

6. FLEXIBILITY OF COATING:

- 6.1. Apparatus: A mechanical bender with free moving points of contact. A test mandrel having a diameter equal to the diameter in inches corresponding to the bar size number.
- 6.2. Frequency: One bar of each size per 8-hour shift, but with a minimum of 2 tests per 8-hour shift.
- 6.3. Procedure: The bending tests shall be conducted at a room temperature between 68 °F and 85 °F after the specimens have been exposed to the room temperature for a sufficient time to ensure that they have reached thermal equilibrium. The bend shall be made at a uniform rate and may take up to one minute to complete. The two longitudinal deformations may be placed in a plane perpendicular to the mandrel radius. Deformed bars shall be bent 180 degrees (after rebound) and dowel bars for transfer assemblies shall be bent 60 degrees (after rebound).

- 6.4. Remarks: A satisfactory coating on the bent bars shall not show any visible evidence of cracking.
7. REPORT: The test results, date, project number, and other general information shall be reported on either the Division of Materials or an approved company work sheet for Epoxy Coated Reinforcing Steel.
8. Insure the facility is participating in the Concrete Reinforcing Steel Institute's certification program. Have the facility provide a copy of their last inspection and any remedial work pending.

APPROVED

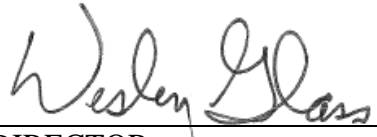

DIRECTOR
DIVISION OF MATERIALS

DATE

02/20/08

Kentucky Method 64-102-08
Revised 02/20/08
Supersedes 64-102-05
Dated 01/04/05

Kentucky Method 64-103-05
Revised 01/04/05
Supersedes KM 64-103-03
Dated 02/07/03

PREPARATION AND TESTING OF WELD SPECIMENS
(Qualifying Shielded Metal Arc Welders)

1. SCOPE: This method covers the procedures used in the preparation and testing of welding specimens submitted to the Division of Materials for the purpose of qualifying shielded metal arc welders by the guided bend test.
2. APPARATUS:
 - 2.1. band saw
 - 2.2. milling machine or shaper
 - 2.3. belt sander
 - 2.4. guided-bend test jig per AWS (American Welding Society) D.1.5 (1.5 inch diameter plunger).
3. PREPARATION OF SPECIMEN: Guided bend test specimens shall be prepared by cutting the test plate to form specimens rectangular in cross section. All cuts will be made perpendicular to the path of welded material with a band saw. One-inch sections will be cut from each side of the test plate and will be discarded. Two test specimens 1.5 inch wide will then be taken from the sides of the test plate. The remaining middle section will be discarded. The back up plate shall be removed flush with the base metal. Flame cutting, milling machine, or shaper may be used for the removal of the major portion of the backing, providing at least 1/8" of its thickness is left to be removed by machining or grinding. The final surface should be smooth with no apparent scratches or gouges. Always grind or machine lengthwise on the specimen. The edges of the test specimen shall be rounded a maximum of 1/8" radius with a file. Air cool and do not water quench. In the finished specimen, the weld area and base metal shall be the same dimensions.
4. TESTING PROCEDURE: Each specimen shall receive a guided bend test in a jig per AWS D.1.5. Any convenient means may be used to move the plunger member with relation to the die member. The specimen shall be placed on the die member of the jig with the weld at midspan. Face bend specimens shall be placed with the face toward the gap. Root bend specimens shall be placed with the root of the weld directed toward the gap. The plunger shall force the specimen into the die until the specimen becomes U-shaped. The fillet weld test specimens shall receive two root bends. The groove weld test specimens shall receive one face and one root bend.

5. TEST RESULTS REQUIRED: The convex surface of the specimen shall be examined for the appearance of cracks or other open discontinuities. Any specimen, in which a crack or other open discontinuity exceeding 1/8 inch measured in any direction is present after the bending, shall be considered as having failed. Cracks occurring on the corners of the specimen during testing shall not be considered.

APPROVED

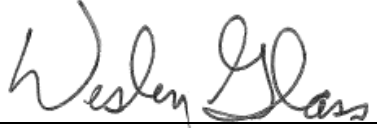

DIRECTOR
DIVISION OF MATERIALS

DATE

01/04/05

Kentucky Method 64-103-05
Revised 01/04/05
Supersedes KM 64-103-03
Dated 02/07/03

Attachment

Groove Weld Test Plate — Welder Qualification

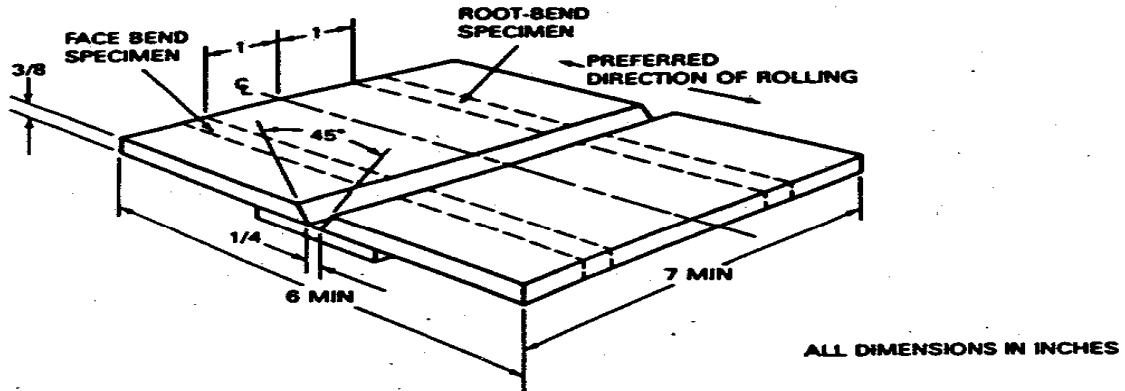

Fillet Weld Root-Bend Test Plate — Welder Qualification

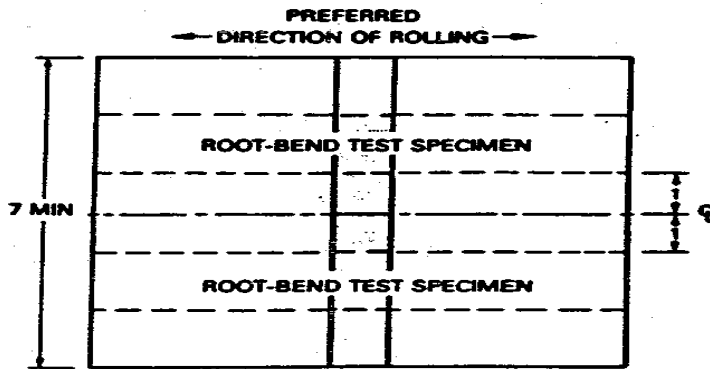

Kentucky Method 64-106-05
Revised 01/04/05
Supersedes KM 64-106-03
Dated 02/11/03

TEST PROCEDURES FOR EPOXY COATED REINFORCING BAR INSTALLATION MATERIALS

1. SCOPE: This method contains procedures for conducting the laboratory acceptance tests for reinforcing bar installation devices such as chairs, bar supports, tie wires, and other metallic accessories.
2. APPARATUS: A tie wire twister and three foot length of #6 (19mm) epoxy coated reinforcing bar.
3. PROCEDURE:
 - 3.1. Chairs, bar supports, etc.: The installation device, while being held firmly in place, shall be capable of having the three foot length of # 6 epoxy coated reinforcing bar pulled across (without any upward or downward force) the support area without suffering any flaking, chipping, or other damage to the coating.
 - 3.2. Tie Wire: The tie wire shall be twisted snugly around two reinforcing bars with a tie wire twister. The coating on the tie wire shall be capable of withstanding the twisting without exposing the base wire around the circumference of the reinforcing bars. The exposure of base wire away from the rebars where only the wires are twisted together will not be cause for rejection.

APPROVED



DIRECTOR
DIVISION OF MATERIALS

DATE

01/04/05

Kentucky Method 64-106-05
Revised 01/04/05
Supersedes KM 64-106-03
Dated 02/11/03

Kentucky Method 64-107-05
Revised 01/04/05
Supersedes KM 64-107-03
Dated 02/11/03

FALLING-HEAD WATER PERMEABILITY OF FILTER FABRIC: DETERMINATION OF PERMEABILITY COEFFICIENT AND FLOW RATE AT A GIVEN CHANGE IN WATER HEAD

1. SCOPE: This procedure provides for (1) determination of coefficient of water permeability for filter fabrics and (2) flow rate of water through a fabric determined by a falling head permeameter test.
2. APPARATUS:
 - 2.1. Falling-head fabric permeameter (50.8 mm. diameter Plexiglas standpipe with a cross-sectional area of 20.27 cm² above a fabric sample placed over a 25.4 mm orifice; the cross-sectional area of flow through the test fabric is 5.07 cm²) (Figure 1).
 - 2.2. Water Supply
 - 2.3. Fabric thickness gauge that meets the requirements outlined in ASTM D1777 71.60 mm diameter pressure foot weighing 454 gms.
 - 2.4. Celsius thermometer
 - 2.5. Stopwatch
 - 2.6. Rubber gaskets to fit flanges in falling-head fabric permeameter.
3. SAMPLE PREPARATION:
 - 3.1. Cut a 76.2 mm x 152.4 mm fabric sample to fit flanges of permeameter.
 - 3.2. Measure thickness of fabric sample according to the procedure outlined in ASTM D1777, record on data sheet (Attachment 1).
 - 3.3. Place fabric layer on bottom flange of permeameter. Attach a rubber gasket of appropriate thickness around fabric.
 - 3.4. Place top section of permeameter over fabric and gasket. Fasten flanges securely with clamps or bolts.
 - 3.5. Fill stand pipe with water.
 - 3.6. Open water release valve for a few seconds to saturate filter fabric. Close valve.
4. TEST PROCEDURE:
 - 4.1. The object of this procedure is to determine the time required for water to travel through

the fabric filter as the height of the water column is reduced from h_o to h_i .

- 4.2. The values recommended for h_o and h_i are 20 cm and 10 cm respectively. This low head level is suggested to provide flow within or close to the laminar range.
- 4.3. An elapse time (t) for the (h_o-h_i) condition should be determined according to the following procedure.
 - 4.3.1. Raise water level in standpipe until it reaches the desired starting height of h_o (20 cm). Use pipette for fine adjustment of pressure head level to exactly h_o .
 - 4.3.2. Record temperature of water in system.
 - 4.3.3. Open water release valve and start stopwatch simultaneously.
 - 4.3.4. Stop stopwatch when water level reaches the desired lower level of h_i (10 cm).
 - 4.3.5. Record time (t) on data sheet.
 - 4.3.6. Repeat above procedures four times.

5. CALCULATIONS: Permeability Coefficient:

The coefficient of permeability, k, is computed using the following equation:

$$k = \left(\frac{aL}{At} \right) \left(\ln \frac{h_o}{h_i} \right)$$

where: a = cross-sectional area of standpipe (cm^2)

L = thickness of fabric sample (cm)

A = cross-sectional area of flow through fabric (cm^2)

T = time in seconds for head of water in standpipe to drop from h_o to h_i

h_o, h_i = heads between which the permeability is determined (20 cm and 10 cm respectively)

For the apparatus described in this test procedure $a = \Pi (1)^2$ and $A = \Pi (0.5)^2$, therefore Equation 1 becomes:

$$k = \left(\frac{4L}{t} \right) \left(\ln \frac{h_o}{h_i} \right)$$

6. FLOW RATE: Flow rate is defined as the flow per unit area through a filter fabric for a given drop in the head of water above the fabric.

The equation for flow rate (FR) follows:

$$FR = \frac{Q}{tA}$$

where: t = time in seconds required for head to drop from h_o to h_i
 Q = volume of flow passing through the fabric
 A = cross-sectional area of flow through fabric (cm²)

By the continuity equation Q = a (h_o - h_i) where a = cross-sectional area of the permeameter standpipe/tank, h_o = original height of water above the fabric (e.g. 20 cm), and h_i = final height water (e.g. 10 cm). For this test procedure a = 20.26 cm² and the area of flow is A = 5.07 cm²

Substituting these values, Equation 3 becomes:

$$FR = \left(\frac{a}{A} \right) \left(\frac{h_o - h_i}{t} \right) = \frac{4(h_o - h_i)}{t}$$

7. **REPORTING RESULTS:** Report k and FR as the average of the five values obtained from this Test Procedure. The calculated values of "k" are corrected to k_{20°C}, the permeability coefficient at 20 °C, using the following equation:

$$k_{20°C} = k \frac{u_t}{u_{20°C}}$$

where: u_t = viscosity of water at temperature of water in system (See Attachment 2),
 u_{20°C} = viscosity of water at 20 °C=10.09 millipoises.

APPROVED

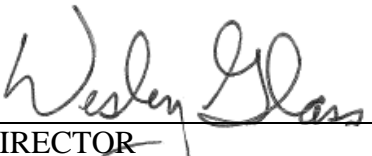

 DIRECTOR
 DIVISION OF MATERIALS

DATE

01/04/05

Kentucky Method 64-107-05
 Revised 01/04/05
 Supersedes KM 64-107-03
 Dated 02/11/03

Attachments

Figure 1
KM 64-107

FIGURE 1 - Falling-Head Fabric Permeameter

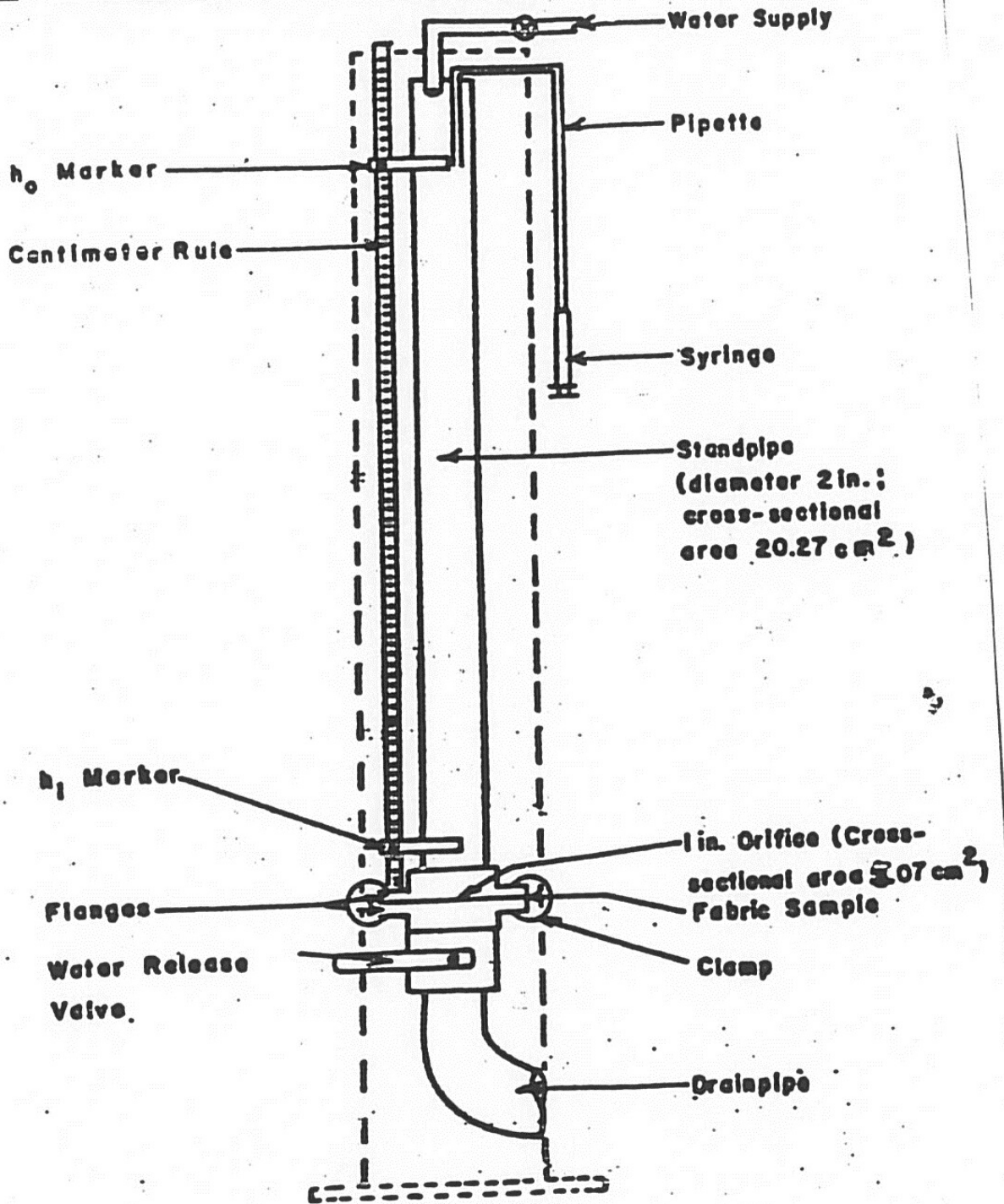

FALLING HEAD PERMEABILITY DATA SHEET
(AASHTO M 288)

County _____ Project _____

Sample I.D. # _____ Date _____

Sample Thickness (L) = _____ in X 2.54 cm/in = _____

Cross-Sectional Areas:

Standpipe (a): $20.27 \text{ cm}^2 = 0.02181 \text{ ft}^2$

Flow through Fabric (b): $5.07 \text{ cm}^2 = 0.00546 \text{ ft}^2$

$(h_0 - h_1) = 20 - 10 = 10 \text{ cm} = 3.94 \text{ in} = 0.328 \text{ ft}$

$\ln (h_0/h_1) = \ln 2 = 0.69$

$Q = a (h_0 - h_1) = 0.02181 (0.328) = 0.007 \text{ ft}^3 = 0.054 \text{ gal.}$

	(sec)		(min)	
1)	_____	=	_____	Temp. (°C) = _____
2)	_____	=	_____	Temp. Correction for Viscosity
3)	_____	=	_____	= (T _c = _____
4)	_____	=	_____	(from chart)
5)	_____	=	_____	
Avg) t =	_____	=	_____	

Coefficient of Water Permeability

$K = \frac{L \text{ (cm)} \times a \text{ (cm}^2)}{A \text{ (cm}^2) \times t \text{ (sec)}} \ln (h_0/h_1) = \frac{L \times 20.27}{5.07 \times t} 0.69 =$

$K = 2.76 \times \frac{L \text{ (cm)}}{t \text{ (sec)}}$

$K = 2.76 \times \text{_____} = \text{_____} \text{ cm/sec}$

Corrected to 20°C
 $k_{20} = k \times T_c = \text{_____} \times \text{_____} = \text{_____} \text{ cm/sec}$

Flow Rate (F.R.) = $\frac{0}{A t \text{ (min)}} = \frac{0.054 \text{ gal}}{0.00546 \text{ ft}^2 \text{ (t(min))}} = \frac{9.89 \text{ gal/ft}^2}{t \text{ (min)}}$

$F.R. = 9.89 \div \text{_____} = \text{_____} \text{ gal./ft}^2 \text{ min.}$

(k (20)) VISCOSITY CORRECTION FACTORS

TEMP. °C	CORRECTION FACTOR (T _c) @ 20°C
18	1.0507
19	1.0248
20	1.0000
21	0.9761
22	0.9532
23	0.9311
24	0.9096
25	0.8892
26	0.8694
27	0.8502
28	0.8318
29	0.8139
30	0.7967
31	0.7801
32	0.7641
33	0.7486
34	0.7334
35	0.7189
36	0.7050
37	0.6912
38	0.6781
39	0.6652
40	0.6527

Kentucky Method 64-108-05
Revised 01/04/05
Supersedes KM 64-108-03
Dated 02/11/03

QUALIFICATION OF GAS METAL ARC (MIG) WELDERS AND PREPARATION AND TESTING OF MIG WELD SPECIMENS

1. SCOPE:

- 1.1. This method, based on modifications of the American Welding Society Structural Code D1.1, current edition, outlines the procedures for qualifying welders for the following positions and types of welds:
 - 1.1.1. 3G: vertical groove
 - 1.1.2. 4G: overhead groove
- 1.2. Qualification in accordance with this method is required prior to performing the following welding operations: grates and frames.
- 1.3. Qualification in accordance with this method has no limitation of thickness that may be welded.

2. LIMITATIONS ON POSITIONS AND TYPES OF WELDING:

- 2.1. Qualification in the 3G position (vertical groove) qualifies a welder for flat, horizontal, and vertical groove and fillet plate welding.
- 2.2. Qualification in the 4G position (overhead groove) qualifies a welder for flat and overhead groove and for flat, horizontal and overhead fillet plate welding.

3. TEST METALS:

- 3.1. The base metal shall be structural steel plates, 1 inch in thickness, conforming to the requirements of ASTM A-36, or ASTM A-36 Modified to include the added requirements of 0.2% copper content. The test specimens shall conform to the dimensions shown in the attachment. Test plates shall be cut to size by means of sawing or shearing only.
- 3.2. The wire size shall be .045" to .063" and it should be equivalent to a 7100 alloy rod or an equivalent flux core wire.

4. AUTHORIZED INSPECTION AND TESTING:

- 4.1. The inspection of welders as they weld test plates in various positions may be performed by any of the following:
 - 4.1.1. Division of Materials (Division) Physical Section personnel.

4.1.2. Welding instructors at approved vocational tech schools

4.1.3. Welding instructors at approved trade schools

4.1.4. Approved commercial testing laboratories

4.2. Testing of Weld Specimens:

4.2.1. Test specimens of welders inspected by the Division will be tested by the Division.

4.2.2. Test specimens of welders inspected by any of the other agencies listed in 4.1 will be tested by the agency performing the welding inspection.

5. WELDING INSPECTOR'S (Anyone Listed in Section 4.1) DUTIES:

5.1. The inspector shall verify that the wire conforms to the requirements of [Section 3.2](#).

5.2. The inspector shall require strict conformance to the procedures, dimensions, positions, and any other requirements of [Section 6](#).

5.3. After air-cooling and removal of slag from the weld metal, the weld specimens shall be inspected for surface defects and irregularities. The inspector shall examine the weld specimens very closely and reject those containing any of the following:

5.3.1. Undercutting.

5.3.2. Lack of fusion at edges of weld.

5.3.3. Lack of penetration and porosity.

5.3.4. Crater cracks.

5.3.5. Cracks in the weld metal.

5.3.6. Base metal cracks adjacent to the welds.

5.4. The inspector shall verify that the welder has marked each test specimen with either paint or metal stencil to identify the position and type of weld.

5.5. All inspectors shall complete form TC 64-753 for each welder taking the qualification test.

5.5.1. Division inspectors submit completed forms and weld specimens in accordance with instructions and examples provided in the [Sampling Manual](#).

5.5.2. Other inspectors shall submit a copy of the TC 64-753 form to the Physical Section, Division of Materials, upon completion of the qualification testing.

6. WELDER QUALIFICATION PROCEDURES: Welders shall be qualified for groove welds (vertical or horizontal positions), depending upon the required type of welding to be performed on

KM 64-108-05

the project.

- 6.1. Groove Weld: In making tests to qualify for groove welds, the test plates shall be welded in the following positions:
 - 6.1.1. 3G-Vertical Groove: The test plates shall be placed in a vertical position and each groove weld shall be made vertically and with a bottom to top placement. See [Attachment No. 1 - Position 3G](#). The entire welding process shall be done with the plates in the vertical position.
 - 6.1.2. 4G-Overhead Groove: The test plates shall be placed so that each groove weld is deposited on the underside of the horizontal plates. See [Attachment No. 1 - Position 4G](#). The entire welding process shall be done with the plates in the overhead position.
- 6.3. The gap, in all cases, shall be filled until the weld metal forms a convex surface slightly above the base metal.
- 6.4. Cleaning between weld passes shall be limited to hand chipping and hand wire brushing. Power chippers or grinders shall not be used during the weld test.

7. PREPARATION AND TESTING OF WELD SPECIMENS:

7.1. Apparatus:

- 7.1.1. band saw.
- 7.1.2. milling machine or shaper.
- 7.1.3. belt sander.
- 7.1.4. guided-bend test jig, per AWS D.1.1 (1.5 inch diameter plunger).

7.2. Preparation Of Specimen For Side Bend:

- 7.2.1. Side bend test specimens shall be prepared by cutting the test plate to form specimens rectangular in cross section. All cuts will be made perpendicular to the path of welded material with a band saw. One inch sections will be cut from each side of the test plate and will be discarded. *Two test specimens 3/8 inches wide will then be taken from the sides of the test plate. The remaining middle section will be discarded. The back up plate shall be removed flush with the base metal. Flame cutting, milling machine, or shaper may be used for the removal of the major portion of the backing, providing at least 1/8" of its thickness is left to be removed by machining or grinding. The final surface should be smooth with no apparent scratches or gouges. Always grind or machine lengthwise on the specimen. The edges of the test specimen shall be rounded a maximum of 1/8" radius with a file. Air cool and do not water quench. In the finished specimen, the weld area and base metal shall be the same dimensions.

* Specimen shall be cut +3/8" to allow for sanding and smoothing the cut surface and saw marks. The finished specimen shall be 3/8" thick by 1" wide with 1/8" maximum radius edges.

7.2.2. Testing Procedure: The Side Bend specimen shall receive a guided bend test in a jig per AWS D.1.1. Any convenient means may be used to move the plunger member with relation to the die member. The specimen shall be placed on the die member of the jig with the weld at midspan. The plunger shall force the specimen into the die until the specimen becomes U-shaped.

7.2.3. Test Results Required: The convex surface of the specimen shall be examined for the appearance of cracks or other open discontinuities. Any specimen in which a crack or other open discontinuity exceeding 1/8" measured in any direction is present after the bending, shall be considered as having failed. Cracks occurring on the corners of the specimen during testing shall not be considered.

8. QUALIFIED STATUS:

- 8.1. If the welder fails to meet the qualification requirements, he may take a re-test provided two test specimens are welded for each specimen that failed. If the re-test specimens do not meet all requirements, the welder must wait 90 days before he can take the test again.
- 8.2. Qualified status shall be limited to two years from the date of completion of testing unless the welder is not engaged in the welding process for which he/she is qualified for a period exceeding 6 months or, in the judgment of the Engineer, there is reason to question the welder's ability.

9. COST OF TESTING:

- 9.1. Division Testing.
 - 9.1.1. The cost of the test plates is always the responsibility of the welder or contractor.
 - 9.1.2. The cost of preparing and testing weld specimens of each welder's first attempt at qualifying will be charged to the project if there is a project.
 - 9.1.3. The cost of preparing and testing weld specimens shall be the responsibility of the welder or contractor if:
 - 9.1.3.1. The welder is taking a re-test.
 - 9.1.3.2. There is no highway project.

9.2. Other Than Division Testing: The welder or contractor shall make their own arrangements with the testing agency.

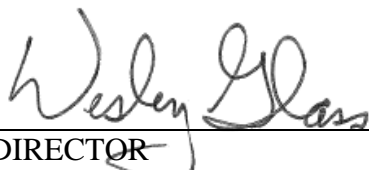
APPROVED 

DIRECTOR
DIVISION OF MATERIALS

DATE 01/04/05

Kentucky Method 64-108-05
Revised 01/04/05
Supersedes KM 64-108-03
Dated 02/11/03

Attachments

DIMENSIONS, JOINT TYPES & POSITIONS FOR TEST PLATES

Groove

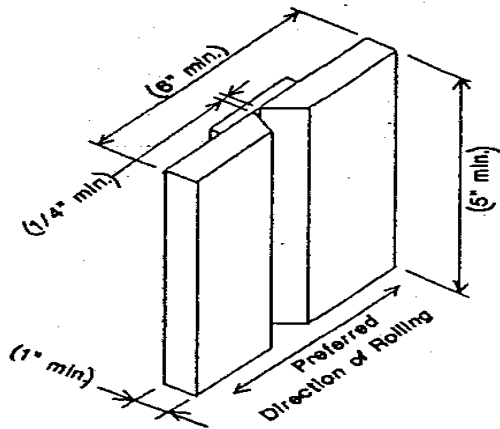

POSITION 3G (Vertical)

1 inch plate, 45 degree single V groove, 1/4 inch root opening, backing 3/8 inch by 1 inch.

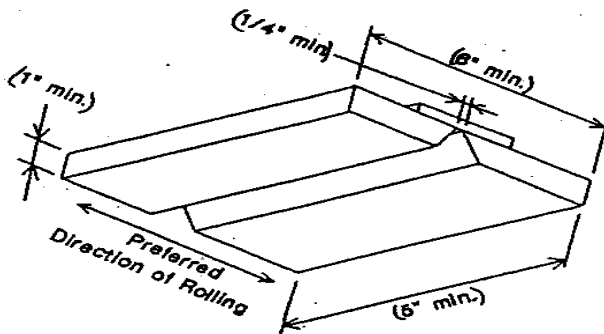

POSITION 4G (Overhead)

1 inch plate, 45 degree single V groove, 1/4 inch root opening, backing 3/8 inch by 1 inch.

ATTACHMENT 1
KM 108

QUALIFICATION OF STEEL REINFORCEMENT TACK WELDERS

1. SCOPE: This method, based on modifications of the AWS (American Welding Society) Bridge Welding Code A5.1, A5.5, A5.18, or D1.4, current edition, outlines the procedures for qualifying tack welders for welding steel reinforcement. Information herein is taken from Section 605 of the [Standard Specifications For Road and Bridge Construction](#).
2. PROCEDURE:
 - 2.1. Use the bar stock and welding equipment that is required for fabrication of the steel at the precast or prestress producer's facility. Acceptable electrodes and welding processes are listed in Section 3.
 - 2.2. Prepare 3 sample tack welds of the following 4 combinations: #4 (13 mm) to #6T (19T mm), #6 (19 mm) to #4T (13T mm), #4 (13 mm) epoxy to #5T (16T mm), and #5 (16 mm) epoxy to #4T (13T mm) where T is the short bar of the welded intersection. Samples do not necessarily need to be cut from a cage but the long bar should be in the vertical position when tack welded, thereby simulating actual welding conditions.
 - 2.3. The bar to be tested shall be approximately 48 inches long. The 'T' cross bar shall be 6-8 inches long. The weld shall join the bars at mid point ± 1 " of each long bar.
 - 2.4. Prepare the bars in the presence of the KYTC inspector. Securely tape the 3 bars of each combination together. The inspector will deliver the test bars (and the appropriate forms) to the Division of Materials for evaluation.
 - 2.5. The Division of Materials' Physical Section will evaluate each bar to determine if the physical properties of the bar have been degraded by the weld. Each bar must meet the minimum requirements for TENSILE and YIELD strength of the bar stock as well as % ELONGATION and BEND. If any bar fails, the 3 bar combination fails. If any combination fails, the welder fails to qualify.
3. ELECTRODES:
 - 3.1. Shielded Metal-arc Process: Use only electrodes with low hydrogen classifications E7015, E7016, E7018, E7028, E9015, E9016, E9018, or E9028 according to AWS A5.1 or A5.5 as applicable.
 - 3.2. Gas Metal-arc Process: Use electrode classification ER70S according to AWS A5.18.
4. QUALIFIED STATUS:
 - 4.1. If the welder fails to qualify, he or she may take a re-test provided double the number of bars are welded for each combination that failed. If any of the re-test bars fail, the welder

must wait 90 days before he or she can take the test again.

4.2. Qualified status shall be limited to two years from the date of completion of testing. If the welder is not engaged in the welding process for which he/she is qualified for a period exceeding 6 months, qualification status may be revoked within that two year period. Or in the judgment of the Engineer there is reason to question the welder's ability, qualification status may be revoked within that two year period.

5. COST OF TESTING:

5.1. The cost of the materials is the responsibility of the welder or fabricator.

5.2. The cost of testing weld specimens shall be the responsibility of the welder or fabricator. Contact the Physical Section in the Division of Materials to schedule testing and to obtain test cost information.

APPROVED

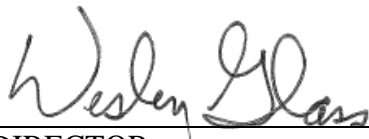

DIRECTOR
DIVISION OF MATERIALS

DATE

03/05/08

Kentucky Method 64-109-08
Revised 03/05/08
Supersedes KM 64-109-06
Dated 10/06/06

Attachment

TACK WELDERS
Section 605.03.04

ID NUMBER _____ Date Sampled _____

INSPECTOR ID _____ INSPECTOR NAME _____

COMPANY NAME _____ LOCATION _____

TYPE OF INSPECTION _____

MATERIAL CODE _____ 7069 _____

Welder SSN _____ Expiration Date _____

Welder Name _____ Previously Approved for KY (Yes) _____ (No) _____

Route or Street _____

City _____ State _____ Zip Code _____

PCN # _____ Project Number _____

Date Received _____ Pass/Fail _____ Date Complete _____

CHECK APPROVED TACK WELDS

4 + 6T _____ 4E + 5T _____

Carbon Equivalent _____ Carbon Equivalent _____

6 + 4T _____ 5E + 4T _____

Carbon Equivalent _____ Carbon Equivalent _____

WELDING PROCESS TYPE: Shielded Metal-Arc _____ Gas Metal-Arc _____

Electrode or Wire Classification _____ Electrode Size _____ Preheat Temperature _____

VISUAL INSPECTION: Appearance _____ Rod Oven Temp °F _____

Undercut _____ Porosity _____

Inspector Observing Welding _____

Title _____ District _____

REMARKS:

COPIES:

QUALIFICATION OF SHIELDED METAL ARC WELDERS

1. SCOPE:

- 1.1. This method, based on modifications of the American Welding Society Bridge Welding Code D1.5, current edition, outlines the procedures for qualifying welders for the following positions and types of welds:
 - 1.1.1. 3F: vertical fillet
 - 1.1.2. 4F: overhead fillet
 - 1.1.3. 2G: horizontal groove
 - 1.1.4. 3G: vertical groove
 - 1.1.5. 4G: overhead groove
- 1.2. Qualification in accordance with this method is required prior to performing the following welding operations:
 - 1.2.1. Splicing steel piles.
 - 1.2.2. Welding grates and frames.
 - 1.2.3. Welding to expansion dams, bearing shoes, beam stiffeners and bridge repair.
 - 1.2.4. Other welding tasks specified or permitted by the Engineer.
- 1.3. Qualification in accordance with this method has a maximum limitation of 3/4 inch plate thickness that may be welded.
- 1.4. Radiographic examination of the test plates is accepted in lieu of a bend test if a private laboratory is performing the test and is qualified for such testing.

2. LIMITATIONS ON POSITIONS AND TYPES OF WELDING:

- 2.1. Qualification in the 3F position (vertical fillet) qualifies a welder for flat, horizontal, and vertical fillet plate welding.
- 2.2. Qualification in the 4F position (overhead fillet) qualifies a welder for flat, horizontal and overhead position fillet plate welding.
- 2.3. Qualification in the 2G position (horizontal groove) qualifies a welder for flat and

horizontal position groove welding and for flat and horizontal position fillet plate welding.

- 2.4. Qualification in the 3G position (vertical groove) qualifies a welder for flat, horizontal, and vertical groove and fillet plate welding.
- 2.5. Qualification in the 4G position (overhead groove) qualifies a welder for flat and overhead groove and for flat, horizontal and overhead fillet plate welding.
- 2.6. Qualification in the 3G and 4G positions (vertical and overhead groove) qualifies a welder for all positions groove and fillet plate welding.

3. TEST METALS:

3.1. The base metal shall be structural steel plates, 3/8 inch in thickness, conforming to the requirements of ASTM A-36, or ASTM A-36 Modified to include the added requirements of 0.2% copper content. The test specimens shall conform to the dimensions shown in [Attachment # 1](#). Test plates shall be cut to size by means of sawing or shearing only.

3.2. Electrodes:

3.2.1. The electrodes (filler metal) shall be AWS classification numbers E 6010, E 6011, or E 7018, as required for the positions, type and polarity of current, and other conditions of intended use.

3.2.2. The electrode size shall be 1/8" to 3/16" inclusive.

4. AUTHORIZED INSPECTION AND TESTING:

4.1. The inspection of welders as they weld test plates in various positions may be performed by any of the following:

4.1.1. Division of Materials (Division) Physical Section personnel.

4.1.2. Welding instructors at approved vocational tech schools.

4.1.3. Welding instructors at approved trade schools.

4.1.4. Approved commercial testing laboratories.

4.2. Testing of Weld Specimens:

4.2.1. Test specimens of welders inspected by the Division's Physical Section will be tested by the Division.

4.2.2. Test specimens of welders inspected by any of the other agencies listed in 4.1 will be tested by the agency performing the welding inspection.

5. WELDING INSPECTOR'S (Anyone Listed in Section 4.1) DUTIES:
 - 5.1. The inspector shall verify that the electrodes conform to the requirements of Section 3.2. The classification number is stamped on each electrode.
 - 5.2. The inspector shall require strict conformance to the procedures, dimensions, positions, and any other requirements of Section 6.
 - 5.3. After air-cooling and removal of slag from the weld metal, the weld specimens shall be inspected for surface defects and irregularities. The inspector shall examine the weld specimens very closely and reject those containing any of the following:
 - 5.3.1. Undercutting.
 - 5.3.2. Lack of fusion at edges of weld.
 - 5.3.3. Lack of penetration and porosity.
 - 5.3.4. Crater cracks.
 - 5.3.5. Cracks in the weld metal.
 - 5.3.6. Base metal cracks adjacent to the welds.
 - 5.4. The inspector shall verify that the welder has marked each test specimen with either paint or metal stencil to identify the position and type of weld.
 - 5.5. All inspectors shall complete form TC 64-753 for each welder taking the qualification test:
 - 5.5.1. Kentucky Transportation Cabinet (KYTC) inspectors submit completed forms and weld specimens in accordance with instructions and examples provided in the Sampling Manual.
 - 5.5.2. Other inspectors shall submit a copy of the TC 64-753 form to the Division, upon completion of the qualification testing.
6. WELDER QUALIFICATION PROCEDURES: Welders shall be qualified for fillet welds (vertical or overhead position) and/or groove welds (horizontal, vertical or overhead position), depending upon the required type of welding to be performed on the project.
 - 6.1. Fillet Welds: In making tests to qualify for fillet welds, test plates shall be welded in the following positions:
 - 6.1.1. 3F-Vertical Fillet: The test plates shall be placed in a vertical position and each fillet weld shall be made vertically and with bottom to top placement. See [Attachment No. 1 - Position 3F](#). The entire welding process shall be done with the plates in the vertical position.

6.1.2. 4F-Overhead Fillet: The test plates shall be placed so that each fillet weld is deposited on the under side of the horizontal surface of the 3/8" x 2" back up plate and against the vertical edges of the base plates. See [Attachment No. 1 - Position 4F](#). The entire welding process shall be done with the plates in the overhead position.

6.2. Groove Weld: In making tests to qualify for groove welds, the test plates shall be welded in the following position.

6.2.1. 2G-Horizontal Groove: The test plates shall be placed in an approximately vertical plane with the welding groove approximately horizontal. See [Attachment No. 1 - 2G](#).

6.2.2. 3G-Vertical Groove: The test plates shall be placed in a vertical position and each groove weld shall be made vertically and with a bottom to top placement. See [Attachment No. 1 - Position 3G](#). The entire welding process shall be done with the plates in the vertical position.

6.2.3 4G - Overhead Groove - The test plates shall be placed so that each groove weld is deposited on the underside of the horizontal plates. See [Attachment No. 1 - Position 4G](#). The entire welding process shall be done with the plates in the overhead position.

6.3 The gap, in all cases, shall be filled until the weld metal forms a convex surface slightly above the base metal. See illustration in [Attachment No. 2](#).

6.4 Cleaning between weld passes shall be limited to hand chipping, hand wire brushing, or powered wire brushes. Power chippers or grinders shall not be used during the weld test.

7. QUALIFIED STATUS:

7.1. If the welder fails to meet the qualification requirements, he may take a re-test provided two test specimens are welded for each specimen that failed. If the re-test specimens do not meet all requirements, the welder must wait 90 days before he can take the test again.

7.2. Qualified status shall be limited to two years from the date of completion of testing unless the welder is not engaged in the welding process for which he/she is qualified for a period exceeding 6 months or, in the judgment of the Engineer, there is reason to question the welder's ability.

8. COST OF TESTING:

8.1. KYTC Testing.

8.1.1. The cost of the test plates is always the responsibility of the welder or contractor.

8.1.2. The cost of preparing and testing weld specimens of each welders first attempt at qualifying will be charged to the project if there is a project.

8.1.3. The cost of preparing and testing weld specimens shall be the responsibility of the welder or contractor if:

8.1.3.1. The welder is taking a re-test.

8.1.3.2. There is no highway project.

8.2. Other Than KYTC Testing: The welder or contractor shall make their own arrangements with the testing agency.

APPROVED

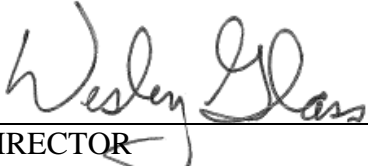

DIRECTOR
DIVISION OF MATERIALS

DATE

01/04/05

Kentucky Method 64-110-05
Revised 01/04/05
Supersedes KM 64-110-03
Dated 02/11/03

Attachments

DIMENSIONS, JOINT TYPES & POSITIONS FOR TEST PLATES

Fillet

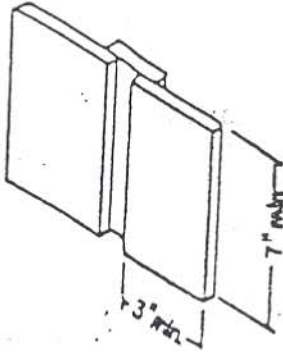

POSITION 3F (Vertical)

3/8 inch plate, 15/16 inch gap between the two pieces of base metal, backing 3/8 inch by 2 inch.

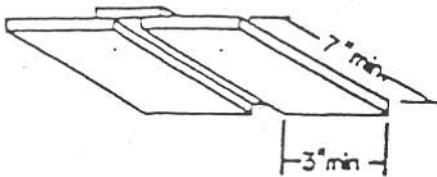

POSITION 4F (Overhead)

3/8 inch plate, 15/16 inch gap between the two pieces of base metal, backing 3/8 inch by 2 inch.

Groove

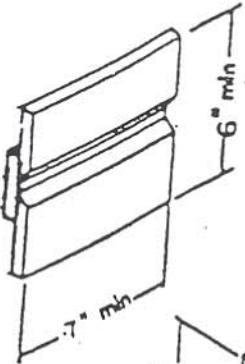

POSITION 2G (horizontal)

3/8 inch plate, 45 degree single V groove, 1/4 inch roof opening, backing 3/8 inch by 1 inch.

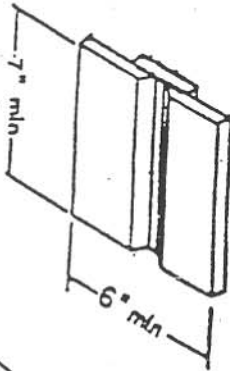

POSITION 3G (vertical)

3/8 inch plate, 45 degree single V groove, 1/4 inch roof opening, backing 3/8 inch by 1 inch.

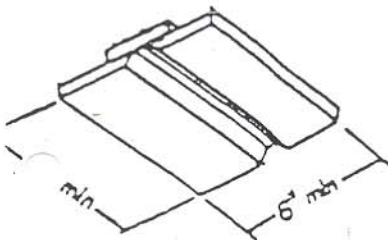

POSITION 4G (overhead)

3/8 inch plate, 45 degree single V groove, 1/4 inch roof opening, backing 3/8 inch by 1 inch.

Attachment No. 1

KM 110

FINISHED WELD SPECIMENS

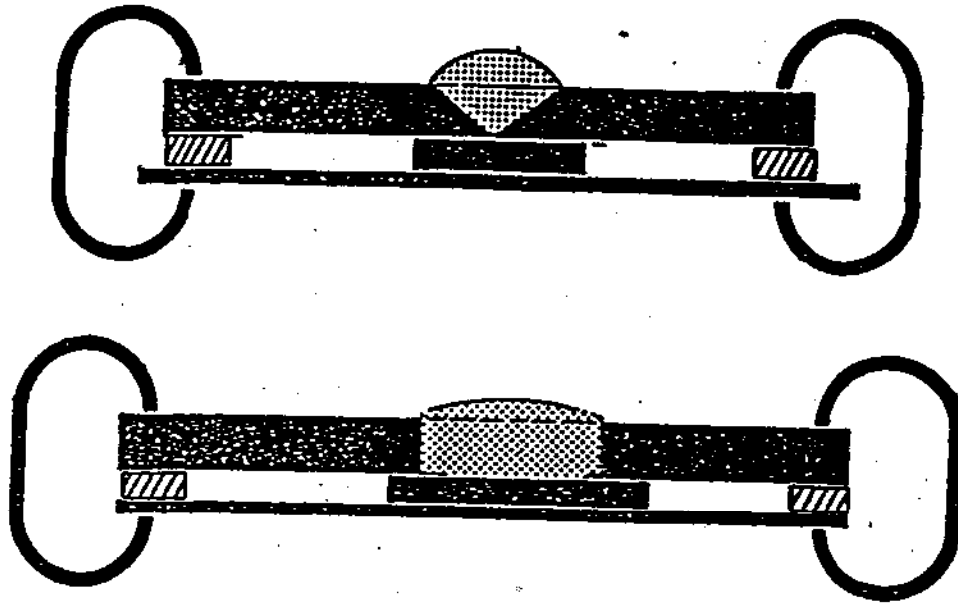

1. Plates should be clamped into position as shown.
2. Welds should be rounded above the top of the plates, as shown, so that machine work will leave smooth surface.

ATTACHMENT No. 2

May 18, 1992

Kentucky Method 64-112-05
Revised 01/31/05
Supersedes KM 64-112-03
Dated 06/20/03

NUMERICAL LIMITS FOR COMPARING TEST RESULTS
(INDEPENDENT ASSURANCE SAMPLING AND TESTING PROGRAM)

1. This method provides numerical limits to use when comparing independent assurance test results, required by the Department of Highways' Independent Assurance Testing Program, to the accompanying comparison tests.
2. General:
 - 2.1. The [attached table](#) designates maximum limits of variability between an individual independent assurance test result and a comparison test result for the various types of material and tests included within this program. Differences between results in excess of those indicated in the table should be investigated for an assignable cause (including additional testing as necessary). Document subsequent findings and/or corrective actions (if any) as part of the independent assurance report.
 - 2.2. The limits in the table are intended for use only when tests are performed as nearly as feasible on the same material, at the same time, and using the same test method or comparable test method permitted for determining acceptance. For valid Independent Assurance Tests, the tests must be performed by different personnel using different test equipment.
 - 2.3. When it is the intent to provide limits in establishing whether erroneous testing procedures, equipment, or both are present, it is necessary to eliminate, insofar as feasible, differences in test results attributable to inherent batch-to-batch or other sources of materials variability and sampling techniques. Therefore, for materials which require sampling, a well-blended quantity sufficient to perform both independent assurance and comparison tests shall be obtained. Test portions shall be obtained by quartering, splitting, or other acceptable procedure to minimize sampling variation. For sieve analysis of aggregates, independent assurance testing should be performed on the identical test portion used for acceptance testing to eliminate any sampling variations.

APPROVED

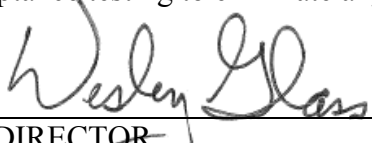

DIRECTOR
DIVISION OF MATERIALS

DATE

01/31/05

Kentucky Method 64-112-05
Revised 01/31/05
Supersedes KM 64-112-03
Dated 6/20/03
Attachment

KM 64-112-05

TABLE

(For Comparing Independent Assurance and Comparison Test Results)

TYPE OF TEST	MATERIAL	MAXIMUM DIFFERENCE BETWEEN TEST RESULTS								
(1) ASPHALT CONTENT DETERMINATION	ASPHALT MIXES	0.5 %								
(2) SIEVE ANALYSIS AND -200 WASH TEST	ASPHALT MIX AGGREGATE	<table style="width: 100%; border: none;"> <tr> <td style="width: 80%;">½-in. and larger Sieves</td> <td style="text-align: right;">5%</td> </tr> <tr> <td>⅜-in., No. 4, No. 8, and No. 16 Sieves</td> <td style="text-align: right;">4%</td> </tr> <tr> <td>No. 30, No. 50, and No. 100 Sieves</td> <td style="text-align: right;">3%</td> </tr> <tr> <td>No. 200 Sieve</td> <td style="text-align: right;">2.0%</td> </tr> </table>	½-in. and larger Sieves	5%	⅜-in., No. 4, No. 8, and No. 16 Sieves	4%	No. 30, No. 50, and No. 100 Sieves	3%	No. 200 Sieve	2.0%
½-in. and larger Sieves	5%									
⅜-in., No. 4, No. 8, and No. 16 Sieves	4%									
No. 30, No. 50, and No. 100 Sieves	3%									
No. 200 Sieve	2.0%									
	DENSE-GRADED AGG. CRUSHED STONE BASE, & CONCRETE AGG.	<table style="width: 100%; border: none;"> <tr> <td style="width: 80%;">Sieves > No. 8</td> <td style="text-align: right;">6%</td> </tr> <tr> <td>Sieves No. 100 Thru No. 16</td> <td style="text-align: right;">4%</td> </tr> <tr> <td>Sieve No. 200 by washing</td> <td style="text-align: right;">1.0%</td> </tr> </table>	Sieves > No. 8	6%	Sieves No. 100 Thru No. 16	4%	Sieve No. 200 by washing	1.0%		
Sieves > No. 8	6%									
Sieves No. 100 Thru No. 16	4%									
Sieve No. 200 by washing	1.0%									
(3) <u>MIXTURE PROPERTIES</u> PERCENT AIR VOIDS AND VOIDS-IN-MINERAL AGGREGATE	ASPHALT MIXES	1.5%								
(4) DENSITY	SOIL, DGA, CSB	4 pcf								
(4a) PROCTOR DENSITY	SOIL	4 pcf								
(5) AIR CONTENT	CEMENT CONCRETE	±0.75%								
(6) SLUMP	CEMENT CONCRETE	±25% of the Maximum Limit								
(7) COMPRESSIVE STRENGTH (CYLINDERS)	CEMENT CONCRETE	The IAS result shall not be less than 85% nor more than 115% of the average compressive strength of the two acceptance cylinders used for comparison.								
(8) TEMPERATURE (CONCRETE)	CEMENT CONCRETE	±3°F								

SAMPLING MATERIALS BY RANDOM NUMBER SAMPLING

1. SCOPE: This method provides a procedure and illustrations, in the form of several examples, for selecting samples using a system of random numbers. To accomplish this selection, choose the random sample so that each unit of material (e.g., cubic yard, square yard, ton, etc.) has the same probability of being selected. Divide each material sampled into lots, and establish a frequency of sampling.
2. PROCEDURE:
 - 2.1. Random numbers can be generated by some calculators by planting a seed number such as date, time of day, etc., expressed as a decimal between 0 and 1. Included in this method are two tables of random numbers which may also be used. Enter the table in a random method, such as a blind placement of a pencil. After choosing the first random number in this manner, choose consecutive numbers, following a column (or row), until the entire table has been used. At that time, repeat the initial process of random entry into the table of numbers. This method will reduce the possibility of using a value from the table more than once. All examples are completed using the tables contained in this method.
 - 2.2. Following are examples related to particular phases of highway construction:
 - 2.2.1. EXAMPLE NO. 1

In this example, select station numbers for Lane Density coring of a 0.75-in. nominal-maximum mixture. Specifications require four Lane Density cores for each 1000 tons of mixture placed. The subplot size is 1000 tons with a frequency of four Lane Density cores per subplot. The subplot of mixture in question will be placed on a 12-ft.-wide lane that is 4545 ft. long. The lift thickness of the 0.75-in. nominal-maximum mixture is 3.0 in. The job starts at Station No. 0+00.

Since four Lane Density cores are required for the entire 4545-ft. length, obtain one core for each 1136.25 ft. of pavement. Use the following steps to determine the station number and offset for each Lane Density core:

 - 2.2.1.1. Refer to the random number table (see p. 5 for example).
 - 2.2.1.2. Enter the table at any point. Select four consecutive numbers from the random number table. Use these numbers for finding the station number of the Lane Density core site in each 1136.25-ft. section.

Multiply each random number by 1136.25 to determine the station number at which to obtain the Lane Density core. After determining the location of the first Lane Density core, for each of the remaining Lane Density cores, add increments of 1136.25 ft., increasing with each Lane Density core, to provide locations throughout the entire subplot length.

SAMPLE NO.	RANDOM NUMBER CALCULATION	STATION NUMBER
1	$0.420 \times 1136.25 = 477.23 + 0.00 = 477$	4 + 77
2	$0.859 \times 1136.25 = 976.04 + 1136.25^* = 2112$	21 + 12
3	$0.011 \times 1136.25 = 12.50 + 2272.50 = 2285$	22 + 85
4	$0.762 \times 1136.25 = 865.82 + 3408.75 = 4275$	42 + 75

*1136.25-ft. increments, as determined by the subplot length, provide resultant numbers throughout the entire subplot length.

According to Subsection 402.03.02 of the *Standard Specifications*, obtain Lane Density cores no closer than six inches from the pavement edge or joint. To select the transverse distance from the pavement edge (left or right), select four additional consecutive numbers from the random number table (see p. 5 for example), and multiply each random number by 11.0 (12-ft. lane width minus the 0.50-ft. offset from each side). For this example, calculate the distance from 0.50 ft. inside of the right edge of the pavement.

SAMPLE NO.	RANDOM NO. CALCULATION	OFFSET FROM RIGHT EDGE
1	$0.062 \times 11.0 + 0.50 =$	1.2 ft.
2	$0.100 \times 11.0 + 0.50 =$	1.6 ft.
3	$0.409 \times 11.0 + 0.50 =$	5.0 ft.
4	$0.784 \times 11.0 + 0.50 =$	9.1 ft.

Therefore, from the calculations above, conform to the Lane Density coring schedule given below for this subplot:

SAMPLE NO.	STATION NUMBER	OFFSET FROM RIGHT EDGE
1	4 + 77	1.2 ft.
2	21 + 12	1.6 ft.
3	22 + 85	5.0 ft.
4	42 + 75	9.1 ft.

With respect to this example, in other cases, the paving length and width will vary, but use the same procedure for obtaining random locations.

2.2.2. EXAMPLE NO. 2

In this example, select trucks to sample for running air content, slump, and concrete cylinders on Class AA Concrete for a bridge deck pour.

The pour will consist of 250 cubic yards of concrete. The trucks will be hauling 10 cubic yards each. The testing frequency is one test for each 50 cubic yards; therefore, there will be at least five tests required. Use the following steps to select the trucks to sample:

2.2.2.1. Refer to the random number table (see p. 5 for example).

2.2.2.2. Select five consecutive numbers from the random number table. Use these numbers to determine which trucks to sample. Multiply each number by 50 (a lot size of 50 cubic yards), and divide the answer by 10 (cubic yards per truck) to determine which trucks to sample.

SAMPLE NUMBER	RANDOM NUMBER	CALCULATED VOLUME (cubic yards)	TRUCK SAMPLED
1	0.007	$x 50 = 0.35 + 0 = 0.35 \div 10 = 0.04^*$	1st
2	0.922	$x 50 = 46.1 + 50^{**} = 96.1 \div 10 = 9.6$	10th
3	0.729	$x 50 = 36.5 + 100 = 136.5 \div 10 = 13.7$	14th
4	0.949	$x 50 = 47.5 + 150 = 197.5 \div 10 = 19.8$	20th
5	0.606	$x 50 = 30.3 + 200 = 230.3 \div 10 = 23.03$	24th

*When the answer contains a decimal, always round upward to the next highest whole number to determine the truck number.

**Add increments of 50 cubic yards (lot size), increasing with each sample, in order to provide sampling throughout the full 250 cubic yards.

2.2.3. EXAMPLE NO. 3

In this example, select the accumulated tonnage of Crushed Stone Base for gradation testing. The frequency for gradation testing of aggregate bases is one test per 2000 tons of material. Plan quantities show 10,000 tons of Crushed Stone Base exist on this project. This quantity will require five gradation tests.

Again, select five consecutive random numbers from the random number table (see p. 5 for example). Use these numbers to determine the accumulated tonnage at which to select the sample.

Multiply each number by 2000 to determine the accumulated tonnage for sampling. Add increments of 2000 tons (lot size), increasing with each sample, in order to provide sampling throughout the full 10,000 tons.

SAMPLE NUMBER	RANDOM NUMBER CALCULATION	ACCUMULATED TONNAGE
1	$0.658 \times 2000 = 1316 + 0 =$	1316
2	$0.747 \times 2000 = 1494 + 2000 =$	3494
3	$0.270 \times 2000 = 540 + 4000 =$	4540
4	$0.715 \times 2000 = 1430 + 6000 =$	7430
5	$0.418 \times 2000 = 836 + 8000 =$	8836

Obtain samples as near the above-listed accumulated tonnages as possible.

- 2.3. The system of selecting random samples can be related to periods of time, number of pieces, tons, etc. The key to randomness, using this method, relies heavily on the manner of entering the table. Do not use the same set of numbers repeatedly.

APPROVED Allen H. Myers
 DIRECTOR
 DIVISION OF MATERIALS

DATE 08/15/14

Kentucky Method 64-113-14
 Revised 08/15/14
 Supersedes KM 64-113-08
 Dated 01/31/05

Attachments

TABLE 1
RANDOM NUMBERS

.600	.504	.248	.230	.996	.462	.422	.054	.224	.121
.116	.227	.802	.349	.241	.956	.079	.632	.126	.677
.098	.726	.507	.607	.963	.410	.572	.777	.237	.851
.147	.867	.802	.416	.370	.377	.775	.256	.348	.148
.644	.067	.001	.158	.702	.148	.667	.217	.421	.149
.310	.531	.520	.560	.888	<i>E.287</i>	.567	.251	.593	.571
.493	.235	.886	.178	.490	<i>X.007</i>	.640	.343	.894	.079
.788	.272	.484	.487	.277	<i>A.922</i>	.435	.716	.924	.304
.652	.523	.317	.601	.705	<i>M.729</i>	.669	.435	.984	.239
.816	.045	.423	.943	.227	<i>#.949</i>	.395	.931	.887	.242
.086	.585	.177	.851	.513	<i>2.606</i>	.911	.253	.669	.328
.689	.755	.027	.183	.024	<i>E.658</i>	.041	.512	.518	.910
.117	.029	.309	.017	.926	<i>X.747</i>	.584	.570	.212	.504
.700	.989	.980	.532	<i>E.640</i>	<i>A.270</i>	.610	.257	.996	.978
.321	.431	.370	.814	<i>X.420</i>	<i>M.715</i>	.548	.148	.953	.450
.515	.775	.759	.438	<i>A.859</i>	<i>#.418</i>	.689	.924	.350	.724
.543	.575	.633	.097	<i>M.011</i>	<i>3.170</i>	.357	.429	.899	.087
.629	.502	.503	.036	<i>#.762</i>	.280	.605	.518	.275	.017
.221	.882	.206	.415	<i>I.776</i>	.548	.520	.417	.253	.808
.751	.446	.189	.776	.465	.936	.970	.467	.371	.077
.553	.160	.464	.309	.298	.304	.613	.512	.816	.270
.384	.778	.284	.435	.246	.319	.078	.695	.152	.637
.969	.740	.102	.093	.055	.155	.225	.782	.226	.250
.085	.125	.750	.900	.991	.887	.993	.183	.096	.542
.667	.355	.784	.803	<i>E.072</i>	.206	.508	.385	.691	.127
.076	.968	.527	.749	<i>X.062</i>	.075	.526	.292	.176	.310
.788	.943	.091	.141	<i>A.100</i>	.040	.750	.870	.249	.345
.165	.422	.601	.095	<i>M.409</i>	.897	.963	.271	.770	.100
.472	.201	.558	.725	<i>#.784</i>	.025	.943	.040	.984	.011
.668	.708	.776	.490	<i>I.270</i>	.868	.658	.954	.916	.955

TABLE 1
RANDOM NUMBERS

.600	.504	.248	.230	.996	.462	.422	.054	.224	.121
.116	.227	.802	.349	.241	.956	.079	.632	.126	.677
.098	.726	.507	.607	.963	.410	.572	.777	.237	.851
.147	.867	.802	.416	.370	.377	.775	.256	.348	.148
.644	.067	.001	.158	.702	.148	.667	.217	.421	.149
.310	.531	.520	.560	.888	.287	.567	.251	.593	.571
.493	.235	.886	.178	.490	.007	.640	.343	.894	.079
.788	.272	.484	.487	.277	.922	.435	.716	.924	.304
.652	.523	.317	.601	.705	.729	.669	.435	.984	.239
.816	.045	.423	.943	.227	.949	.395	.931	.887	.242
.086	.585	.177	.851	.513	.606	.911	.253	.669	.328
.689	.755	.027	.183	.024	.658	.041	.512	.518	.910
.117	.029	.309	.017	.926	.747	.584	.570	.212	.504
.700	.989	.980	.532	.640	.270	.610	.257	.996	.978
.321	.431	.370	.814	.420	.715	.548	.148	.953	.450
.515	.775	.759	.438	.859	.418	.689	.924	.350	.724
.543	.575	.633	.097	.011	.170	.357	.429	.899	.087
.629	.502	.503	.036	.762	.280	.605	.518	.275	.017
.221	.882	.206	.415	.776	.548	.520	.417	.253	.808
.751	.446	.189	.776	.465	.936	.970	.467	.371	.077
.553	.160	.464	.309	.298	.304	.613	.512	.816	.270
.384	.778	.284	.435	.246	.319	.078	.695	.152	.637
.969	.740	.102	.093	.055	.155	.225	.782	.226	.250
.085	.125	.750	.900	.991	.887	.993	.183	.096	.542
.667	.355	.784	.803	.072	.206	.508	.385	.691	.127
.076	.968	.527	.749	.062	.075	.526	.292	.176	.310
.788	.943	.091	.141	.100	.040	.750	.870	.249	.345
.165	.422	.601	.095	.409	.897	.963	.271	.770	.100
.472	.201	.558	.725	.784	.025	.943	.040	.984	.011
.668	.708	.776	.490	.270	.868	.658	.954	.916	.955

TABLE 2
RANDOM NUMBERS

.605	.973	.319	.294	.236	.572	.216	.973	.931	.870
.720	.497	.679	.634	.299	.578	.743	.835	.062	.200
.918	.295	.295	.777	.854	.281	.867	.864	.374	.748
.294	.396	.441	.321	.655	.191	.205	.899	.807	.186
.089	.927	.802	.530	.937	.257	.530	.005	.539	.999
.591	.409	.668	.967	.993	.920	.812	.018	.578	.618
.494	.808	.410	.097	.633	.149	.547	.895	.829	.953
.021	.699	.597	.286	.982	.953	.913	.422	.291	.979
.926	.085	.758	.624	.491	.694	.496	.490	.949	.457
.351	.709	.461	.093	.498	.377	.639	.801	.388	.334
.329	.857	.949	.550	.095	.906	.596	.462	.891	.758
.126	.525	.834	.677	.045	.699	.568	.147	.902	.664
.572	.101	.066	.147	.069	.006	.979	.259	.765	.460
.728	.374	.402	.679	.601	.492	.002	.512	.529	.089
.524	.346	.698	.133	.013	.907	.992	.453	.883	.684
.176	.870	.306	.179	.071	.854	.086	.414	.973	.785
.031	.437	.512	.107	.842	.507	.458	.018	.881	.506
.826	.110	.065	.878	.182	.460	.442	.504	.075	.027
.945	.640	.283	.330	.163	.496	.767	.543	.921	.923
.948	.890	.677	.328	.075	.752	.207	.692	.268	.204
.232	.639	.425	.434	.795	.329	.941	.026	.867	.035
.896	.502	.074	.092	.203	.625	.541	.505	.835	.021
.643	.838	.357	.294	.592	.440	.676	.186	.304	.212
.552	.892	.843	.851	.685	.847	.963	.189	.604	.634
.623	.955	.024	.718	.534	.978	.962	.208	.645	.811
.988	.648	.182	.983	.128	.784	.606	.138	.208	.337
.326	.500	.874	.958	.826	.523	.462	.823	.955	.773
.130	.545	.756	.164	.418	.817	.707	.882	.984	.903
.907	.419	.705	.597	.655	.566	.546	.738	.614	.373
.859	.365	.476	.351	.154	.458	.645	.303	.631	.832

CAMERA/VIDEO INSPECTION OF PIPE WITH ALTERNATE METHODS OF DEFLECTION MEASUREMENT

1. SCOPE: This method provides procedures for camera inspection of pipe and three methods of determining deflection: laser, mandrel testing, and physical measurements.
2. APPARATUS:
 - 2.1. Camera Inspection Equipment: Provide a pipeline inspection camera having the following features:
 - Configured properly in the pipe both vertically and horizontally, and having the ability to pan and tilt to a 90 degree angle with the axis of the pipe and rotate 360 degrees.
 - Low barrel distortion camera.
 - Color image with a minimum standard resolution of 720 x 480 pixels.
 - Equipped with sufficient lighting to provide a clear image of the full circumference of the pipe.
 - Capable of recording the station, milepost, distance along the invert of the pipe, or other indicators of location superimposed on the video.
 - Capable of moving through entire length of pipe.
 - Capable of measuring cracks greater than 0.1” and joint separations greater than 0.5”.
 - Software capable of generating a report that shows each fault along with its location from the inspection entrance and a still frame image of the fault.
 - 2.2. Laser deflection measuring device: For use on Corrugated Metal Pipe, High Density Polyethylene Pipe, and Polyvinyl Chloride Pipe up to 48 inches in diameter, provide a laser deflection measuring device capable of measuring deflection to an accuracy of 0.5% or better and a repeatability of 0.12% or better.
 - 2.3. Mandrel: For use on Corrugated Metal Pipe, High Density Polyethylene Pipe, and Polyvinyl Chloride Pipe, use a mandrel device with an odd number of legs (9 minimum) having a length not less than the outside diameter of the mandrel. The diameter of the mandrel at any point shall not be less than the diameter specified in Section 3.6. Mandrels can be a fixed size or a variable size. The diameter of the mandrel, whether it is fixed or variable size, must be verified with a proving ring or other method as per the manufacturer’s guidelines.
 - 2.4. Physical Measuring Tools: Use contact or non-contact distance instruments.

3. PROCEDURE:

- 3.1. Ensure pipe is clear of water, debris or obstructions. Complete the video inspection and any necessary measurement prior to placing the final surface over any pipe. When paving will not be delayed, take measurements 30 days or more after the completion of earthwork to within 1 foot of the finished subgrade. Notify the Engineer a minimum of 24 hours in advance of inspection And notify the Engineer immediately if distresses or locations of improper installation are logged.
- 3.2. Pipeline Video Inspection for Defects and Distresses:
 - 3.2.1. Begin at the outlet end and proceed through to the inlet at a speed less than or equal to 30 ft/minute. Remove blockages that will prohibit a continuous operation.
 - 3.2.2. Document locations of all observed defects and distresses including cracking, reinforcing steel showing, sags, joint offsets, joint separations, deflections, improper joints/connections, blockages, leaks, rips, tears, buckling, deviation from line and grade, and other anomalies not consistent with a properly installed pipe..
 - 3.2.3. During the video inspection provide a continuous 360 degree pan of every pipe joint.
 - 3.2.4. Identify and measure all cracks greater than 0.1” and joint separations greater than 0.5”.
 - 3.2.5. Video Inspections are conducted from junction to junction which defines a pipe run. A junction is defined as a headwall, drop box inlet, curb box inlet, manhole, buried junction, or other structure that disturbs the continuity of the pipe. Multiple pipe inspections may be conducted from a single set up location, but each pipe run must be on a separate video file and all locations are to be referenced from nearest junction relative to that pipe run.
 - 3.2.6. Record and submit all data as per Section 4.1.
- 3.3. Pipeline Laser Inspection for Deflection:
 - 3.3.1. Calibrate the laser deflection measuring device according the manufacturers specifications. Provide all calibration data and applicable manufacturers recommendations for calibration and use to the Engineer.
 - 3.3.2. Measure the deflection occurring at the point of the projected laser and at a minimum interval of 0.1 feet along the pipe.
 - 3.3.3. All deflection measurements are to be based off of the AASHTO Nominal Diameters. Refer to Section 3.6.
 - 3.3.4. Inspect at a speed that will provide proper data acquisition to effectively measure the maximum deflection. The inspection speed shall be less than or equal to 30 ft/minute.

- 3.3.5. Laser inspections are to be conducted in the same manner as Section 3.2.5.
- 3.3.6 Record and submit all data as per Section 4.2.
- 3.4. Mandrel Testing: Mandrel testing will be used for deflection testing if the video measurements are called into question or if limitations in the laser deflection measuring device are exceeded. Physical measurements as described in Section 3.5 may also be used in lieu of the laser or mandrel methods.
 - 3.4.1. Use proving ring or other method recommended by the mandrel manufacturer to verify mandrel diameter prior to inspection. Provide verification documentation for each size mandrel to the Engineer.
 - 3.4.2. All deflection measurements are to be based off of the AASHTO Nominal Diameters. Refer to Section 3.6.
 - 3.4.3. Begin by using a mandrel set to the 5.0% deflection limit. Place the mandrel in the inlet end of the pipe and pull through to the outlet end. If resistance is met prior to completing the entire run, record the maximum distance achieved from the inlet side, then remove the mandrel and continue the inspection from the outlet end of the pipe toward the inlet end. Record the maximum distance achieved from the outlet side.
 - 3.4.4. If no resistance is met at 5.0% then the inspection is complete. If resistance occurred at 5.0% then repeat 3.4.1 and 3.4.2 with the mandrel set to the 10.0% deflection limit. If the deflection of entire pipe run cannot be verified with the mandrel then immediately notify the Engineer.
 - 3.4.5. Record and submit all data as per Section 4.3.
 - 3.4.6. Care must be taken when using a mandrel in all pipe material types and lining/coating scenarios. Pipe damaged during the mandrel inspection will be video inspected to determine the extent of the damage. If the damaged pipe was video inspected prior to mandrel inspection then a new video inspection is warranted and supersedes the first video inspection. Immediately notify the Engineer of any damages incurred during the mandrel inspection and submit a revised video inspection report.
- 3.5. Physical Measurements: Alternate method for deflection testing when there is available access or the pipe is greater than 48 inches in diameter.
 - 3.5.1. Use a contact or non-contact distance instrument as per Section 2.4.1. A leveling device is recommended for establishing or verifying vertical and horizontal control.
 - 3.5.1. Physical measurements may be taken after installation and compared to the AASHTO Nominal Diameter of the pipe as per Section 3.6. When this method is used, determine the smallest interior diameter of the pipe as measured through the center point of the pipe (D2). Take the D2 measurements at the most deflected portion of the pipe run in question and at intervals no greater than ten (10) feet through the run. Calculate the deflection as follows:

$$\% \text{ Deflection} = [(AASHTO \text{ Nominal Diameter} - D2) / AASHTO \text{ Nominal Diameter}] 100\%$$

Note: The Engineer may require that preset monitoring points be established in the culvert prior to backfilling. For these points the pre-installation measured diameter (D1) is measured and recorded. Deflection may then be calculated from the following formula:

$$\% \text{ Deflection} = [(D1 - D2) / D1] (100\%)$$

3.5.2. Record and submit all data as per Section 4.2.

3.6. AASHTO Nominal Diameters and Maximum Deflection Limits: These deflection limits are the maximum allowable deflection on any axis within the pipe and not just in the XY plane.

Base Pipe Diameter (inches)	AASHTO Nominal Diameter (inches)	Max. Deflection Limit (inches)		
		5.0%	7.5%	10.0%
15	14.76	14.02	13.65	13.28
18	17.72	16.83	16.39	15.95
24	23.62	22.44	21.85	21.26
30	29.53	28.05	27.32	26.58
36	35.43	33.66	32.77	31.89
48	47.24	44.88	43.70	42.52
54	53.15	50.49	49.16	47.84
60	59.06	56.11	54.63	53.15

4. REPORTING: Submit all recorded information to the Engineer on standard forms along with the complete video inspection on DVD in digital format. The forms included in this method shall be used for reporting the inspection information. Ensure all video pipe runs on the DVD have the station, milepost, distance into the drain or other indicators of location superimposed on the video. Submit two copies of the paper inspection report forms (one copy to the Section Engineer and one copy to Central Office Division of Construction), a copy of the DVD and one electronic copy of the report. All inspection reports shall be completed on the attached forms and shall be clearly named and organized in the electronic copy.

4.1. Pipeline Video Inspection Report: The Pipeline Video Inspection Report shall include the “Pipe Video Inspection Summary Report” form, the “Individual Pipe Video Inspection Report” form(s), and the report(s) generated by the inspection software for each pipe run.

4.1.1. Individual Pipe Video Inspection Report form: Complete Project Information, Inspector Information, and Pipe Information. Under Inspection Information record each defect/distress and joint along with its distance from the inspection entrance in feet and in sequence. Attach a copy of the report generated from the inspection software and reference the page number associated with the still image of the joint, distress/defect along with any additional information.

- 4.1.2. Pipe Video Inspection Summary Report form: This page is to be used as the cover sheet for the completed video inspection report. Complete Project Information, Inspector Information, and Pipe Information.
- 4.2. Pipeline Deflection Inspection Report: The Pipeline Deflection Inspection Report shall include the "Pipe Deflection Inspection Summary Report" form, the "Individual Pipe Deflection Inspection Report" form(s), and the report(s) generated by the inspection software for each pipe run. If using physical measurements, as per Section 3.5, then include a copy of all calculations.
 - 4.2.1 Individual Pipe Deflection Inspection Report form: Complete Project Information, and Inspector Information. Under Inspection Information record each joint location along with the beginning and ending locations where the deflection exceeds 5.0%, 7.5%, and 10.0%. Attach a copy of any supportive information generated from the inspection software and reference the page number where more detailed deflection information may be conveyed.
 - 4.2.2. Pipe Deflection Inspection Summary Report form: This page is to be used as the cover sheet for the completed deflection inspection report. Complete Project Information, Inspector Information, and Pipe Information.

Kentucky Transportation Cabinet
 Division of Construction, 3rd Floor
 200 Mero Street
 Frankfort, Kentucky 40622

APPROVED



 DIRECTOR
 DIVISION OF MATERIALS

DATE

05/22/14

Kentucky Method 64-114-14
 Revised 05/22/14
 Supersedes KM 64-114-12
 Dated 06/15/12



INDIVIDUAL PIPE VIDEO INSPECTION REPORT

PROJECT INFORMATION

Contract ID # _____ Item # _____ Date _____
District _____ County _____ Route _____

INSPECTOR INFORMATION

Inspecting Contractor _____
Operator Name _____ Operator Name _____
Operator Name _____ Operator Name _____

PIPE INFORMATION

Inspection Date _____ Installation Date _____ Begin Station _____ End Station _____
Pipe Diameter _____ Pipe Material _____ Pipe Length _____ Inspected Length _____
Pipe Application Type _____ Backfill Material _____ Embankment Height _____
Lining Type _____ Under Pavement _____

INSPECTION INFORMATION

INSPECTION INFORMATION (cont.)

Location	Comment	Page	Location	Comment	Page



PIPE VIDEO INSPECTION SUMMARY REPORT

PROJECT INFORMATION

Contract ID# _____ Item # _____ Date _____
District _____ County _____ Route _____
Inspecting Contractor _____ Operator Name _____
Operator Name _____ Operator Name _____
Inspecting Contractor Signature _____ Date _____

INSPECTOR INFORMATION

PIPE INFORMATION

Beginning Station	Ending Station	Dia.	Material	Length	Type	Under Pavement	Cracks >0.1"	Joint Separations	Other	Pages



INDIVIDUAL PIPE DEFLECTION INSPECTION REPORT

PROJECT INFORMATION

Contract ID# _____ Item # _____ Date _____
 District _____ County _____ Route _____

INSPECTOR INFORMATION

Inspecting Contractor _____ Operator Name _____
 Operator Name _____ Operator Name _____
 Operator Name _____

PIPE INFORMATION

Inspection Date _____ Installation Date _____ Begin Station _____ End Station _____
 Pipe Diameter _____ Pipe Material _____ Pipe Length _____ Inspected Length _____
 Pipe Application Type _____ Backfill Material _____ Embankment Height _____
 Lining Type _____ Under Pavement _____ Calibration Method _____

INSPECTION INFORMATION

INSPECTION INFORMATION (cont.)

INSPECTION INFORMATION		INSPECTION INFORMATION (cont.)	
Location	Comment	Location	Comment



PIPE DEFLECTION INSPECTION SUMMARY REPORT

PROJECT INFORMATION

Contract ID# _____ Item # _____ Date _____
 District _____ County _____ Route _____

INSPECTOR INFORMATION

Inspecting Contractor _____ Date _____
 Operator Name _____ Operator Name _____
 Operator Name _____ Operator Name _____
 Inspecting Contractor Signature _____ Date _____

PIPE INFORMATION

Beginning Station	Ending Station	Date	Dia.	Material	Length	Type	Under Pavement	> 5%	> 7.5%	> 10%	Pages

APPROVAL PROCESS FOR PRODUCERS OF CULVERT PIPE

1. SCOPE:
 - 1.1. This method covers the requirements for the qualification of culvert producing facilities. It is intended to provide standards for quality control (QC) plans at all culvert producing facilities (concrete, metal and plastic) to assure that adequate measures are taken during production to consistently produce high quality drainage products.
 - 1.2. This method does not purport to address all of the safety concerns, if any, associated with its use. It is the responsibility of the user of this method to establish appropriate safety and health practices and determine the applicability of regulatory limitations prior to use.
2. BASIC REQUIREMENTS:
 - 2.1. Qualified production plants must have an in house QC plan approved by the Kentucky Transportation Cabinet (KYTC).
 - 2.2. The plant must have or have ready access to an approved testing facility.
 - 2.3. The plant must have a QC technician approved by the KYTC or qualified by an agency approved by the KYTC.
 - 2.4. Manufacturers of thermoplastic pipe must participate in the National Transportation Product Evaluation Program (NTPEP) for Thermoplastic Pipe (THP).
3. QC PLAN: Detail how the producer proposes controlling the equipment, materials and production methods to insure that the specified products are obtained. Indicate the personnel responsible for production and QC at the site. Designate a contact person at each plant. Include the following specific information in the QC plan:
 - 3.1. Identify the physical location of the plant in relation to highways and towns.
 - 3.2. Detail the method of identification of each lot of material during manufacture, storage and shipment.
 - 3.3. Detail the method of sampling and testing raw materials and the finished product. Include lot sizes and types of tests performed as well as a description of equipment and calibrations performed on the testing equipment.

- 3.4. Include a plan for dealing with QC sample failures. Detail how the producer will initiate an immediate investigation into all sample failures and how corrective action will be implemented to resolve the problem. This must also include the test used for this evaluation and the person(s) responsible for making the determination.
 - 3.5. Specify a loading and shipping control plan, which includes a description of the methods by which the products are to be loaded and shipped for use by the KYTC. Include safeguards against loading non-specification material. The plan must also include methods of insuring that all products are accurately identified.
4. APPROVED TESTING FACILITIES: The program requires all tests to be conducted at facilities approved by the KYTC. Each producer may establish and maintain its own laboratory for the performance of QC testing, or the KYTC will consider a producer's request to utilize an approved independent laboratory. The equipment required for an approved laboratory shall be sufficient to perform the required tests referenced in the applicable AASHTO standards that detail the manufacture of the products. Records on instrument calibration must be maintained at the laboratory. The KYTC may require a demonstration of the equipment and procedures.
5. QC TECHNICIAN: All samples must be taken and tested by QC technicians approved by the KYTC or qualified by an agency approved by the KYTC. Identify the QC technicians that are responsible at each plant. The designated QC technicians will be responsible for the overall QC at the plant. The KYTC may require a demonstration of the equipment and procedures used by the technician.
6. ANNUAL GUARANTEE AND REGISTRATION: Submit an Annual Guarantee stating that the pipe conforms to the requirements of all applicable AASHTO and ASTM standards and the current Kentucky Specifications for Road and Bridge Construction (Specifications). Identify all brand markings for pipe produced at all locations. Include with the "Annual Guarantee", calibration sheets for all applicable equipment, and a list of personnel with the required certifications. Submit the "Annual Guarantee" for the next calendar year's production by December 31st of each calendar year.
7. PLANT APPROVAL PROCESS:
 - 7.1. Submit a written request for approval to: Director, KYTC Division of Materials (Division) 1227 Wilkinson Boulevard, Frankfort, KY 40601-1226. The written request must identify the type and diameters of pipe that will be produced. Two copies of the producer's written QC plan must be submitted with the request for approval. Submit a copy of the annual guarantee with the request.
 - 7.2. Submit documentation detailing the information necessary in order to complete a profile analysis in accordance with AASHTO LRFD Bridge Design specifications to the Director of KYTC Division of Structural Design.
 - 7.3. After review and approval of the producer's submittal, KYTC personnel will schedule an on site inspection. The on site inspection will verify that the producer's QC plan is in

effect and is being followed and that at least one qualified technician is on site and will be present when material is being produced under this program. The testing facilities and equipment are subject to inspection. If either the producer's QC plan or laboratory does not meet KYTC requirements, the producer will be informed of the deficiencies in writing. Once the deficiencies have been addressed, the producer may again submit a request for approval in writing to the Director of the Division of Materials.

8. **QUALIFICATION FOR PARTICIPATION IN THE QC/QA PROGRAM:** If the KYTC has approved the producer's written QC plan and the on site inspection confirms that the initial program requirements have been met, the KYTC will issue a letter qualifying the plant for participation in the program for one year. At the end of the year, and each subsequent year, the KYTC may conduct another on site inspection after receipt of the annual guarantee and registration, and if all requirements are continuing to be met, the plant will be requalified for participation in the program for that year. Random inspections and materials sampling may be conducted at any time by the KYTC to verify compliance with the program requirements. Failure to perform all of the program requirements may result in a producer being removed from the program.
9. **SAMPLING AND TESTING PROCEDURES:**
 - 9.1. **Producer's QC:** The producer's QC samples are intended for use by the producer to monitor the quality of material being produced and shipped.
 - 9.1.1. **Specifications:** The producer is to perform all sampling and testing in accordance with the current Specifications.
 - 9.1.2. **Comparison Testing:** Samples of materials and pipe taken by KYTC personnel during plant visits may be split with half of the sample being tested by the producer and half of the sample tested by KYTC.
 - 9.2. **Specific Requirements For Corrugated Metal Pipe (CMP):**
 - 9.2.1. **Pre-Production Testing:**
 - 9.2.1.1. The steel producer will identify the coils as production heats. Each coil of steel shall be clearly stamped and heat identifiable.
 - 9.2.1.2. Perform material evaluations on all materials used for the production of KYTC pipe. The incoming material evaluations shall consist of a physical verification of gauge and heat reports of coil stock.
 - 9.2.1.3. Each lot or heat of material incorporated in the finished products will require a material evaluation.

9.2.2. Production:

- 9.2.2.1. Perform random evaluations of corrugation depth and width at least twice for each production shift.
- 9.2.2.2. At start up and at least once during each shift evaluate the lock seam for retaining offset and lap. Welded seam pipe will be continuously evaluated on the line for weld defects.
- 9.2.2.3. Conduct continuous visual inspections on the exterior of the pipe for deficiencies in the formation of the corrugations and the seam.
- 9.2.2.4. Inspect recorruagated ends for open seams and rough or sharp edges.
- 9.2.2.5. If the pipe is to be bituminous coated, monitor coating temperatures and check the pipe for appropriate coating thickness.

9.2.3. Post Production:

- 9.2.3.1. Remove all barbs and protrusions from the recorruagated ends of the pipe.
- 9.2.3.2. Visually inspect pipe for coating (zinc or aluminum) integrity. Repair any damaged or peeling coating by cleaning the area (with a wire brush or disc sander) and brush applying zinc rich primer. The zinc rich primer shall contain at least 60% metallic zinc in the dried film. Polymer coated pipe requires inspection for coating integrity and repairs to damaged areas is to be in accordance with AASHTO M245.
- 9.2.3.3. Care shall be taken in storage so that the pipe is not bent or punctured by forklifts or other equipment in the storage yard.
- 9.2.3.4. Spray paint a symbol on the outside ends of a color approved by the Division to facilitate identification of the producer. For coated pipe the symbol shall be applied so that it is clearly visible at the job site.
- 9.2.3.5. Perform a final visual inspection on the finished pipe prior to shipment.
- 9.2.3.6. Scan and email all pipe certifications to the Physical section at time of shipment in addition to sending the certifications with the shipment.

9.3. Specific Requirements For Reinforced Concrete Pipe (RCP):

9.3.1. Pre-Production Testing:

- 9.3.1.1. All of the ingredient materials in RCP will be sampled and evaluated for the appropriate properties as referenced in the Specifications and detailed in Site Manager.
- 9.3.1.2. Perform material evaluations on all materials used for the production of KYTC pipe. The incoming material evaluations shall consist of a check of the cement, aggregate and steel reinforcement certifications for RCP.
- 9.3.1.3. Each lot or heat of material incorporated in the finished products will require a material evaluation.
- 9.3.1.4. Producer will notify the Concrete section prior to producing any special design pipe. Special design means any pipe that requires Department approval.

9.3.2. Production:

- 9.3.2.1. Check the steel reinforcement placement on the first piece produced of each different size or class prior to concreting. Insure specified concrete cover will be achieved.
- 9.3.2.2. Conduct thorough visual inspections after form removal for honeycombing, slumping, and general finish.

9.3.3. Post Production:

- 9.3.3.1. Check for correct markings indicating class, date cast, and producer name and location mark.
- 9.3.3.2. Randomly select two joints of pipe from a lot (date) or group of lots (dates) for each size and class of each 500 joints (200 if diameter is 50 inches or greater) produced. At least one joint should be selected from the youngest (or next to youngest) when several of the lots being tested are less than seven days old.
- 9.3.3.3. Check the selected joints for dimensional conformity.
- 9.3.3.4. Use either a three-edge bearing test or compressive strength cores from the selected joints for acceptance. If thickness of the wall is less than 4 inches a three-edge bearing test will be required.

- 9.3.3.4.1. When performing the three-edge bearing test on the selected joints of pipe, apply the D-load required to produce a 0.01-inch crack to one joint. Continue applying D-load to produce the required ultimate load. If required ultimate load is achieved prior to the 0.01 inch crack, release the load and allow shipment.
 - 9.3.3.4.2. Apply the D-load required to produce a 0.01-inch crack to the second joint. If the load required to produce the 0.01-inch crack is exceeded by 5% and the 0.01-inch crack has not occurred, release the load and allow shipment of that joint of pipe. If the required ultimate load is applied without a 0.01 inch crack, release the load and allow shipment.
 - 9.3.3.5. Test one sample of each class or mix design produced every three months for absorption.
 - 9.3.3.6. Perform a final visual inspection on the finished pipe prior to shipment.
 - 9.3.3.7. Scan and email all pipe certifications to the Physical section at time of shipment in addition to sending the certifications with the shipment.
- 9.4. Specific Requirements For High Density Polyethylene Pipe (HDPE) and Polypropylene Pipe (PP):
- 9.4.1. Pre-Production Testing:
 - 9.4.1.1. A lot is defined as a shipment or shipments (railcar or truckload) of resin which has been certified by the supplier or producer.
 - 9.4.1.2. Perform material evaluations on all materials used for the production of KYTC pipe. The incoming material evaluations shall consist of a minimum density and melt index test on each lot of polyethylene resin for HDPE and PP.
 - 9.4.2. Production:
 - 9.4.2.1. Perform the unit weight test a minimum of one (1) time per shift on all 4 inch diameter pipe and larger. This would be per diameter, per machine, per shift.

9.4.2.2. Measure wall thickness for uniformity at the same frequency as the unit weight.

9.4.2.3. Conduct continuous visual inspections on the exterior and interior wall for bonding, blowouts, etc. during production.

9.4.3. Post Production:

9.4.3.1. Conduct a brittleness test a minimum of one (1) time per shift in accordance with the requirements specified in AASHTO M 252, M 294 or M330, whichever is applicable to the pipe being tested.

9.4.3.2. Perform a melt index and density test on the finished product when a piece is rejected because of defects that are suspected of being related to material properties. Grind the rejected pipe and perform the test on the ground material as a verification test or as a step in problem resolution. These tests may not have to be performed if it is determined that the defects are caused by mechanical problems in production.

9.4.3.3. Perform a final visual inspection on the finished pipe prior to shipment.

9.4.3.4. Scan and email all pipe certifications to the Physical section at time of shipment in addition to sending the certifications with the shipment.

9.5. Specific Requirements For Polyvinyl Chloride Pipe (PVC):

9.5.1. Pre-Production Testing:

9.5.1.1. A lot is defined as a shipment or shipments (railcar or truckload) of resin which has been certified by the supplier or producer.

9.5.1.2. Perform material evaluations on all materials used for the production of KYTC pipe. The incoming material evaluations shall consist of a tensile strength and modulus of elasticity, a flexural yield strength, an impact strength and a deflection temperature on each lot of PVC resin for PVC pipe.

9.5.2. Production:

9.5.2.1. Diameter and wall thickness measurements shall be performed a minimum of one (1) time per shift.

9.5.2.2. Pipe flattening, impact strength and pipe stiffness shall be performed a minimum of one (1) time per shift.

9.5.3. Post Production:

9.5.3.1. If failures are encountered during production an “acetone immersion” test shall be performed.

9.5.3.2. A final visual inspection shall be performed on the finished pipe prior to shipment.

9.5.3.3. Scan and email all pipe certifications to the Physical section at time of shipment in addition to sending the certifications with the shipment.

10. TEST FAILURE RESOLUTION: Tests performed on materials prior to production, during production, and post production will be required to meet all of the applicable specifications and references found in the Specifications. Segregate and identify any material or products that do not comply with Specifications.

11. SAMPLE IDENTIFICATION AND RECORD KEEPING:

11.1. Identify producer’s QC samples with consecutive numbers. (QC1, QC2, etc.) Number the samples consecutively for the entire calendar year.

11.2. Retain QC and quality assurance data for at least two years. Make all data available to the KYTC for review upon request.

11.3. Include lot identification on all QC test reports.

11.4. Test reports do not have to be filed for specific projects.

12. KYTC QUALITY ASSURANCE SAMPLES: The KYTC’s QA samples are intended to verify the performance of the producer’s QC plan.

12.1. The KYTC may sample incoming material during plant visits for testing and evaluation. The material sampled does not have to be material that is to be incorporated into pipe produced for the KYTC.

12.2. The KYTC may sample pipe during plant visits for testing. These samples may be split with the producer performing the same tests for comparison.

12.3. KYTC samples taken from projects or maintenance yards may also be tested.

12.4. Pipe may be rejected at any point during this process if it fails to meet the minimum standards established in the current specifications.

13. QC/QA COMPARISON:

13.1. Sample Comparison: The producer's QC test results and the corresponding KYTC QA test results will be compared to verify the performance of the sampling and testing procedures and results. If the results of the QA tests are not in reasonable agreement with the results of the corresponding QC tests, an investigation will be made to determine the source of the difference. The investigation will include a review of the sampling and testing procedures and the testing equipment. The results of the investigation will be recorded and made available to the producer.

13.2. Resolution Procedures:

13.2.1. Comparison Testing/Rejection: In the event that the above referenced investigation does not resolve the difference and the results of the next QA sample are not in agreement with the corresponding QC sample, a resolution system will be employed. The resolution system will require that two additional samples be taken. The samples are to be taken by KYTC personnel and are to be shared with the producer for testing at the producer's lab. The average test results of the two QA samples are to be within the appropriate specification limits and the comparison of the two averages is to be within five percent of each other. If these results are not within the appropriate specification limits and the comparison of the average test results is not within five percent, the material will be rejected. If rejected, the material is to be disposed of in a manner approved by the KYTC.

13.2.2. Comparison Testing/Acceptance: If the test results of the comparison tests indicate that the material is within the specification requirements, but the comparison of the QC samples and the QA samples are not within five percent, the material will be accepted for use. However, the producer, with the assistance of the KYTC, must determine the cause of the differences in test results.

13.2.2.1. If the cause is determined to be improper sampling or testing procedures by the producer or the KYTC, the appropriate qualified QA or QC technician will be notified. If the problem continues, the technician's qualification may be revoked.

13.2.2.2. If the cause is determined to be in the producer's testing equipment or handling of the material, the producer is to take corrective action. If the problem continues, the producer's approval to provide material to the KYTC may be revoked.

13.2.2.3. If the cause is determined to be in the KYTC's testing equipment, the KYTC will take corrective action.

14. PROJECT ACCEPTANCE OF PIPE: Send a Statement of Product Certification with each shipment of culvert to each project. Include specific lot identification and production dates. Examples of these Product Certification forms are attached. The Statement of Certification should state that the manufacturing process followed all applicable AASHTO or ASTM standards, is Build America/Buy America compliant, and that the culvert is from an approved producer. Include the physical location of the plant and the signature of the producer's QC technician from that specific location.

15. DISQUALIFICATION OF PRODUCERS: Producers that are qualified under these requirements may be disqualified and not permitted to supply pipe to KYTC projects if the following occurs:
 - 15.1. During any two (2) inspections by KYTC personnel, the production facility is not following the approved QC plan.
 - 15.2. The producer has falsified QC records.
 - 15.3. Production records indicate that the facility is accepting materials that do not meet the minimum specification requirements.
 - 15.4. The producer supplies products (to more than one project) that do not meet the minimum specification requirements and fails to notify the KYTC and take the appropriate corrective actions.

APPROVED

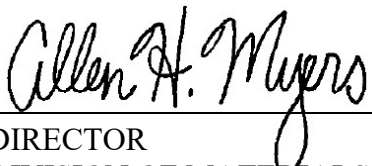

DIRECTOR
DIVISION OF MATERIALS

DATE

09/04/24

Kentucky Method 64-115-24
Revised 09/04/24
Supersedes KM 64-115-24
Dated 04/24/24
Attachments

**REINFORCED CONCRETE PIPE PRODUCER'S
CERTIFICATE OF COMPLIANCE**

**TO: KENTUCKY TRANSPORTATION CABINET (KYTC)
KENTUCKY DEPARTMENT OF HIGHWAYS (KYDOH)
DIVISION OF MATERIALS**

CONTRACTOR _____

COUNTY _____ DATE _____

PROJECT NO _____

- PIPE DATA -

TYPE-CLASS	DIAMETER	NUMBER OF JOINTS	PRODUCTION DATES

THIS IS TO CERTIFY THAT ALL MATERIALS IN THIS SHIPMENT COMPLY IN ALL RESPECTS TO THE APPLICABLE REQUIREMENTS OF SECTION 810 OF THE CURRENT STANDARD SPECIFICATIONS AND ARE FROM A PRODUCER ON THE APPROVED LIST.

COPIES OF INGREDIENT MATERIALS SAMPLED AND APPROVED ARE ON FILE AND AVAILABLE AT ANY TIME IN OUR PLANT OFFICE.

PRODUCER

LOCATION

QC TECHNICIAN

***CORRUGATED METAL PIPE
PRODUCER'S CERTIFICATE OF COMPLIANCE***

**TO: KENTUCKY TRANSPORTATION CABINET (KYTC)
KENTUCKY DEPARTMENT OF HIGHWAYS (KYDOH)
DIVISION OF MATERIALS**

CONTRACTOR: _____ **DATE:** _____

PROJECT NO.: _____ **COUNTY:** _____

QUANTITY	DESCRIPTION OF MATERIALS	FABRICATION LOTS OR HEATS

THIS IS TO CERTIFY THAT ALL MATERIALS IN THIS SHIPMENT COMPLY IN ALL RESPECTS TO THE APPLICABLE REQUIREMENTS OF SECTION 810 OF THE CURRENT STANDARD SPECIFICATIONS AND ARE FROM A PRODUCER ON THE APPROVED LIST. THIS PRODUCT ADHERES TO FEDERAL AND STATE REQUIREMENTS FOR MANUFACTURING WITHIN THE UNITED STATES AND IS BUY AMERICA COMPLIANT. PRODUCT CONTAINS TEN (10) PERCENT POST-CONSUMER WASTE OR RECOVERED MATERIAL.

COPIES OF CERTIFIED MILL TEST REPORTS, SHOWING COMPLIANCE IN FULL TO THE APPLICABLE SPECIFICATION BY NUMERICAL TEST RESULTS, FOR EACH HEAT, LOT AND GAUGE INCLUDED IN THIS SHIPMENT ARE ON FILE AND AVAILABLE IN OUR PLANT OFFICE.

PRODUCER

LOCATION

QC TECHNICIAN

***THERMOPLASTIC (HDPE/PVC) PIPE
PRODUCER'S CERTIFICATE OF COMPLIANCE***

**TO: KENTUCKY TRANSPORTATION CABINET (KYTC)
KENTUCKY DEPARTMENT OF HIGHWAYS (KYDOH)
DIVISION OF MATERIALS**

CONTRACTOR: _____ **DATE:** _____

PROJECT NO.: _____ **COUNTY:** _____

TYPE	DIAMETER (INCHES)	QUANTITY (LINEAR FEET)	LOT NUMBER

THIS IS TO CERTIFY THAT ALL MATERIALS IN THIS SHIPMENT COMPLY IN ALL RESPECTS TO THE APPLICABLE REQUIREMENTS OF SECTION 810 OF THE CURRENT STANDARD SPECIFICATIONS AND ARE FROM A PRODUCER ON THE APPROVED LIST. THIS PRODUCT ADHERES TO FEDERAL AND STATE REQUIREMENTS FOR MANUFACTURING WITHIN THE UNITED STATES AND IS BUILD AMERICA/BUY AMERICA COMPLIANT.

PRODUCER

LOCATION

QC TECHNICIAN

STANDARD OPERATING PROCEDURE FOR
ACCEPTANCE OF GUARDRAIL SYSTEMS

1. SCOPE:

- 1.1. This standard operating procedure presents and outline of the responsibilities of fabricators intending to provide guardrail elements for use on Kentucky department of Highways (Department) projects and the duties of Department personnel assigned to perform the required inspection. Section 814 of the Kentucky Standard Specifications for Road and Bridge Construction (Specifications) shall govern.
- 1.2. It is the joint function of the Division of Materials (Division), the District Materials Engineer (DME) and project personnel (Engineer) to inspect and verify that guardrail elements delivered to projects meet specification requirement.

2. ACCEPTANCE:

- 2.1. Each fabricator must qualify with the Division to supply guardrail beam elements under the following acceptance procedure. To be considered under the procedure, the fabricator must submit a written request to the Division stating a desire to participate in the quality control and guarantee program. To qualify for the quality control and guarantee program, the fabricator must comply with all of the following requirements.
 - 2.1.1. Furnish the Division a notarized annual guarantee that all guardrail beam elements furnished to Department projects will comply with specifications. An “Annual Certification and Guarantee” is attached for completion and submittal to the Division. The guarantee shall be sworn to for the fabricator by a person having legal authority to bind the company.
 - 2.1.2. Submit to the Division in writing, an acceptable quality control plan for manufacturing guardrail elements. Include any updates to QC Plan with Annual Certification and Guarantee. The QC Plan may consist of a report prepared by the fabricator which documents for each specific product, method identification of heats, coating lots, etc., that are maintained by the fabricator as a quality control program. Inspectors from the Division may make periodic visits to the manufacturing plants to verify the quality control procedures of that plant. This will include checking inspection reports for dates and shifts to confirm that quality control tests and checks are being run as well as checking current production and inspection procedures. The Division reserves the right to withhold approval of any procedures judged to be inadequate for acceptable quality control.
 - 2.1.3. Furnish a certified mill test and coating report for every heat number and coating lot representing material to be shipped to a Department project by the following procedure: Fabricator will furnish shipping report for with corresponding certified mill test reports along with the shipment.

- 2.1.4. Marking of beam element shall be in accordance with the appropriate section of AASHTO M 180 and the manufacturer's name or brand and heat number shall be legible after galvanizing and remain legible for a minimum of five years.
 - 2.2. Participation in the Department's quality control and guarantee program does not negate the Department's authority to take random samples from the fabricator's or contractor's stock, and to sample and test random samples from the projects.
3. PROJECT ACCEPTANCE:
 - 3.1. Project personnel will accept guardrail and accessories as follows:
 - 3.1.1. Check to insure that the guardrail is from an approved fabricator.
 - 3.1.2. Obtain the shipping report form with corresponding certified mill test reports.
 - 3.1.3. Check the certified mill test report information for accuracy and conformance to applicable specifications.
 - 3.1.4. Make a visual inspection of each delivery of the rail for white rust and other surface defects during installation.
 - 3.1.5. Perform field verification tests for coating thickness and weight using Guardrail Galvanizing Thickness Worksheet (attached) (ref: ASTM A 123 Table 2).
 - 3.2. Any failure occurring on a sample will require further investigation to determine the acceptability of the rail. If there is evidence of any misrepresentation by the fabricator, the material in question will be either rejected and the fabricator removed from the list of approved fabricators or will be placed on three (3) months probation, at the discretion of the Division. Samples for tests or measurements may be taken at any time deemed desirable by the Department.
4. INSTRUCTIONS FOR MEASURING GUARDRAIL BEAM GAUGE THICKNESS: Guardrail beam gauge thickness shall be measured with a micrometer capable of reading to 0.001 inch (0.025 mm). A minimum of three readings shall be taken in each location, measured and averaged to determine a thickness for that location. This measurement shall be performed at three locations, top and bottom, for a section of rail. This check will be performed by representatives of the Department in the manufacturer's plant during visits to their plant or at the project site during field inspection. The thickness shall conform to the requirements of Table II of AASHTO M 180.
5. INSTRUCTIONS FOR MEASURING ZINC COATING THICKNESS: Coating thickness measurements are taken in accordance with ASTM E 376. Place the rubber magnet housing on the coated surface with the gauge held parallel to the surface. The scale ring of the gauge is then slowly turned forward to bring the magnetic tip into contact with and perpendicular to the coating surface. The scale ring is then slowly turned by hand until the spring tension on the magnet just overcomes the attractive force between the magnet and substrate of the coated surface. At this point, the magnetic tip breaks loose from the coated surface and the inspector stops rotating the scale ring and takes a reading. The break in contact is shown by an indicator and can also be felt and heard. Since the strength of the magnetic attraction related to the thickness of the coating

between the magnet and substrate, the spring tension required to equal this force is measureable. The scale ring is calibrated in units of coating thickness (1 mil = 0.001 inch).

6. INSTRUCTIONS FOR MEASURING WEIGHT OF ZINC COATING:

- 6.1. The thickness of the coating shall be determined as described in the previous section. A minimum of five readings shall be taken at three different spots on each side of the element. The spots shall be located at each end (no closer than three inches) and the middle of a full length section. Reading shall be taken on each side of the element directly opposite from each other at each spot. The weight of zinc coating in oz/ft² is obtained by dividing the average value in mils by 1.7 (or compare to Table 2, ASTM A 123). The average of these 10 readings at each individual spot shall meet the minimum requirements of AASHTO M 180, Table 2 for a single spot test and the average of all three spots shall meet the requirements of M 180, Table 2 for a triple spot test.
- 6.2. The minimum frequency for verifying coating weight shall be one test each for posts, terminal sections, metal spacer blocks (if allowed) and rail for each 3000 lf of guardrail system per source. If the guardrail shows any signs of white rust, submit a four foot section for the Division for testing, regardless or quantity.
- 6.3. The referee test for coating weight will be the stripping method which is performed at the Division. This requires cutting samples from the rail and submitting them for test to the Division. Referee testing is required when the zinc coating weight fails to meet the minimum requirements.

7. ACCEPTANCE PROCEDURES FOR NON-SPECIFICATION GUARDRAIL:

- 7.1. It is intended that all guardrail used in Department work shall meet the requirements of the applicable specifications. However, when guardrail is incorporated into the project that fails to meet specifications the material may be accepted with a reduction in pay provided that the failure is marginal and will not cause poor performance. When the failure falls outside the limits of the reduction chart the guardrail shall be removed and replaced unless the Engineer determines that the guardrail can remain in place at a 100% reduction rate. The payment reduction will be calculated on the bid price in place. Guardrail that fails and has not been incorporated into work will be rejected and shall not be used on the project or any other Department project. The properties that will be tested will be gauge thickness and zinc coating thickness/weight and visual inspection for white rust. Gauge thickness must meet the specification requirement. The referee test for zinc coating weight will be the stripping method performed at the Division. Referee samples will be taken when failures are experienced by the Engineer. Referee sample size shall be 3 in. x 14 in. when cut with a torch or 2 in. x 14 in. piece when cut smoothly with a saw.

ZINC COATING WEIGHT PAYMENT REDUCTION

Zinc Coating (oz/ft ²)	≥4.0	<4.0-3.6	<3.6-3.2	<3.2-2.8	<2.8
*Reduction Rate	0%	5%	15%	25%	**

*The payment reduction will be calculated on the bid price in place.

**Guardrail shall be removed and replaced unless the Engineer determines the guardrail and remain in place at a 100% reduction rate.

- 7.2. Thickness samples shall be taken as described on the Guardrail Galvanizing Thickness Worksheet. The procedure will normally consist of a triple spot test.
- 7.3. A visual inspection of the rail for white rust will be performed by the Engineer, preferably prior to erecting the rail. Removing the white rust is possible with concurrence of the Engineer. The Engineer will determine which of three payments apply for white rust damage: 1) Accept with no deduction, 2) Accept with a ten percent deduction, or 3) Reject with not payment-remove and replace.

APPROVED

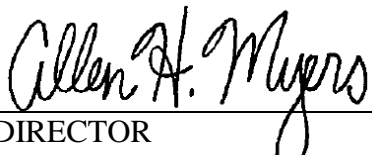

DIRECTOR
DIVISION OF MATERIALS

DATE

04/07/17

Kentucky Method 64-116-17

Dated 04/07/17

Attachments

YEARLY CERTIFICATION AND GUARANTEE FOR GUARDRAIL
KENTUCKY DEPARTMENT OF HIGHWAYS

_____ guarantees that all
(Company Name)

_____ furnished to
(Type of Material)

Kentucky Department of Highways projects in the forthcoming twelve (12) months will be in accordance with and fully comply to the requirements of Section 814 of the Kentucky Standard Specifications for Road and Bridge Construction (Specifications) and will be replaced without cost to the purchaser and Commonwealth of Kentucky when found not in conformity with any of the specifications. We certify that we accept full responsibility for determining the governing specifications for each order and further certify that all materials will meet the specifications and details which apply to each other.

Very truly yours,

(Company Name)

(Company Official's Signature)

(Date)

(Company Official's Name)

(Notary Public) (Date)

**GUARDRAIL GALV. THICKNESS WORKSHEET
TABLE 2, TYPE 2**

SPOT 1

1. _____
2. _____
3. _____
4. _____
5. _____

Front

TOTAL _____ +5=
AVG. _____

SPOT 2

1. _____
2. _____
3. _____
4. _____
5. _____

Back

TOTAL _____ +5=
AVG. _____

SPOT 3

1. _____
2. _____
3. _____
4. _____
5. _____

Back

TOTAL _____ +5=
AVG. _____

SPOT 1

1. _____
2. _____
3. _____
4. _____
5. _____

Back

TOTAL _____ +5=
AVG. _____

SPOT 2

1. _____
2. _____
3. _____
4. _____
5. _____

Back

TOTAL _____ +5=
AVG. _____

SPOT 3

1. _____
2. _____
3. _____
4. _____
5. _____

Back

TOTAL _____ +5=
AVG. _____

FRONT _____
BACK _____
TOTAL _____ +1.7=
*AVG. _____

FRONT _____
BACK _____
TOTAL _____ +1.7=
**AVG. _____

FRONT _____
BACK _____
TOTAL _____ +1.7=
***AVG. _____

* Min. for single spot 3.6 oz/ft²

Sum of oz/ft² of spot 1, 2 & 3

TOTAL _____ +3 =
AVG. _____

Minimum check limit triple spot test average 4.00 oz/ft²

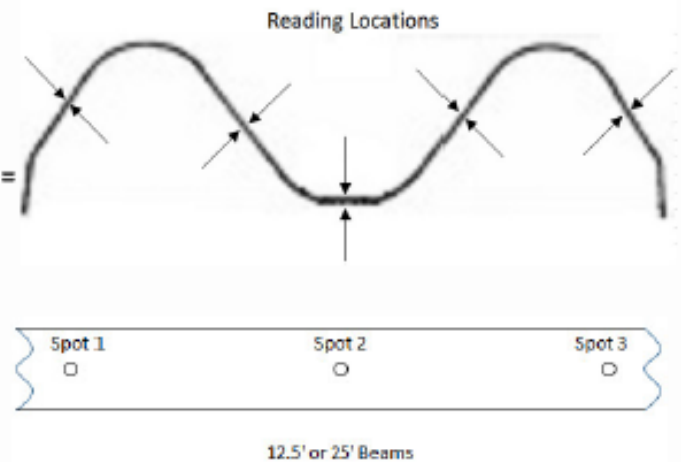

Gage Type _____ Serial/State# _____ Date _____

EVALUATION OF RETROREFLECTIVITY ON INTERSECTION PAVEMENT MARKINGS USING PORTABLE HAND-OPERATED INSTRUMENTS

1. SCOPE:
 - 1.1. This method covers the evaluation of retroreflectivity on pavement markings using portable hand-operated instruments.
 - 1.2. It is intended to provide standards of intersection pavement markings to assure that adequate retroreflectivity for the driver is provided by newly applied markings.
 - 1.3. Thermoplastic intersection pavement markings will be evaluated in a period of not less than 15 to no more than 45 days after the date the materials are applied.
2. TERMINOLOGY: Retroreflectivity: a standard of measure for pavement markings. The units for these readings are millicandelas per square meter per lux (mcd/m²/lx).
3. SUMMARY OF SPECIFICATION:
 - 3.1. Perform a visual inspection and bond checks for each marking.
 - 3.2. Perform retroreflectivity tests at each intersection on at least 2 markings.
 - 3.3. For the purpose of evaluating retroreflectivity, each marking will be considered separately with 2 readings taken on each marking evaluated. Readings will not be taken on portions of the marking that are in the wheel track or where build up of road debris such as oil, grease, etc. would provide readings not representative of the quality of the work.
4. PERFORMANCE REQUIREMENTS:
 - 4.1. Retroreflectivity: The pavement marking will be evaluated for acceptance within the time period detailed in section 1.3.
 - 4.2. If all four readings taken in an intersection meet or exceed the required minimum retroreflectivity values established for the materials that are being measured, the intersection markings that are being evaluated will be accepted.
 - 4.3. If any of the readings taken in an intersection are below the required minimum retroreflectivity values established for the materials that are being measured, additional readings will be taken within the intersection that is being evaluated.
 - 4.4. Taking additional readings: At the discretion of the engineer, additional readings may be taken to assess which markings within an intersection need to be replaced or repaired.

5. REPORTING:

5.1. Include the following in the inspection report:

5.1.1. Printout of the readings taken with the hand-operated instrument (which should show date and time of test and zero reading and calibration). The readings shall be printed from either the on-board printout on the hand-operated instrument or an on-site printer linked directly to the hand-operated instrument.

5.1.2. Date and time of application of the pavement marking from the Contractors Daily Report.

5.1.3. Location (County, intersection, marking tested and any special information).

5.2. Readings shall be recorded in millicandelas per square meter per lux (mcd/m²/lx).

5.3. Measurement shall be reported for each intersection of markings per day.

APPROVED

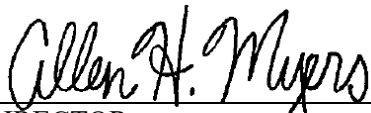

DIRECTOR
DIVISION OF MATERIALS

DATE

02/22/23

Kentucky Method 64-201-23

Dated 02/22/23

Supersedes KM 64-201-08

Dated 02/04/08

EVALUATION OF RETROREFLECTIVITY ON PAVEMENT MARKINGS USING PORTABLE HAND-OPERATED INSTRUMENTS

1. SCOPE:

- 1.1. This method covers the evaluation of retroreflectivity on pavement markings using portable hand-operated 30-meter geometry instruments.
- 1.2. It is intended to provide standards of horizontal pavement markings to assure that adequate retroreflectivity for the driver is provided by newly applied markings.
- 1.3. Waterborne and durable waterborne pavement markings will be evaluated in a period of not less than 30 to no more than 60 days after the date the materials are applied.
- 1.4. Durable pavement markings such as Thermoplastic, Permanent Pavement Tapes, and Epoxies will be evaluated in a period of time not less than 150 days to no more than 210 days after the date the materials are applied.

2. TERMINOLOGY:

- 2.1. Section: a portion of striping completed for a single color per line width by one striping crew in one shift.
- 2.2. Segment: a portion equal to one fifth (or more) of a section.
- 2.3. Zone: a location in each segment where one begins taking retroreflectivity readings.
- 2.4. Retroreflectivity: a standard of measure for pavement markings. The units for these readings are millicandelas per square meter per lux ($\text{mcd}/\text{m}^2/\text{lx}$).
- 2.5. Crew: a group of two or more people identified by the striper and the driver of the striper applying pavement markings.
- 2.6. Shift: a period of time whereby a single crew works continuously stopping only for legally required breaks

3. SUMMARY OF SPECIFICATION:

- 3.1. For the purpose of evaluating retroreflectivity, each section will be evaluated separately. Divide each section into segments containing a zone (as shown in [Figure 1A](#), [Figure 1B](#), [Figure 1C](#), and as described in Step 3.2). Establish five segments to collect readings to represent a day's striping if the total day's striping is >30 miles. Establish three segments to collect readings to represent a day's striping if the total day's striping is >10 miles and <30 miles. If the total day's striping is <10 miles the day will be considered one segment.

Figure 1A. Striping Day (> 30 miles)

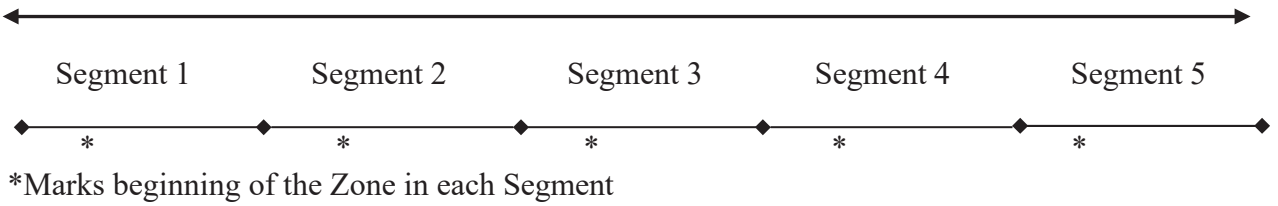

Figure 1B. Striping Day (> 10 miles and < 30 miles)

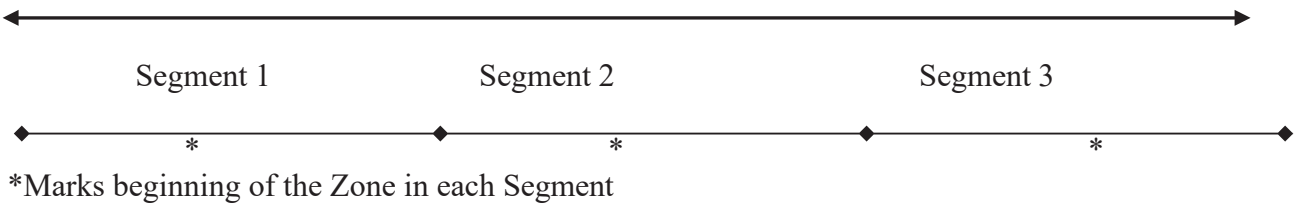
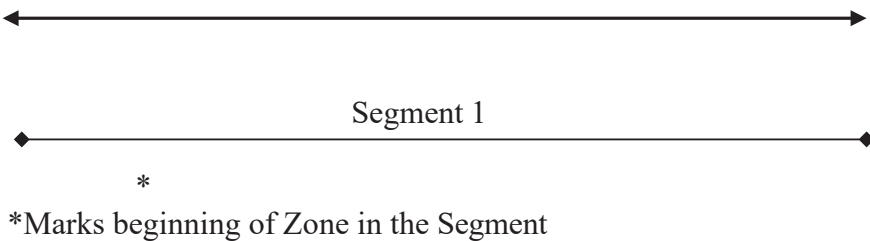

Figure 1C. Striping Day (< 10 miles)



3.2. As stated in Step 3.1, divide the number of miles striped in a day to establish the length of each segment. In the first segment, randomly generate a milepoint (to the nearest tenth of a mile) to begin taking readings in the first zone. The distance from the beginning of the segment to the beginning of the zone (distance a^*), in the first zone, will be used to establish the location of each successive zone within successive segments (See Figure 2)

Figure 2.



NOTE: a^* =distance each time, from beginning of each segment, to beginning of zone.

- 3.3. Mark the beginning and ending point of each zone with spray paint. Make sure the calibration transfer is not more than one week old. Perform a daily calibration on the hand-operated instrument according to the manufacturer's instructions. Print the calibration readings at the beginning of each days work. Recalibrate the instrument every 2 hours when taking continuous readings or before taking readings if the instrument has not been used for 30 minutes or more. Print the calibration readings each time these operations are performed.
- 3.4. Take 20 readings in each of the zones in the direction the striper applied the traffic markings. Take the first reading exactly at the beginning of the zone. Take subsequent readings at approximately 15-foot intervals (5 paces). If any portion of the zone is unsafe for taking readings, move forward to the first point which can be inspected safely and begin the zone there. Do not move the zone simply for convenience. A change in the starting point of one zone should not change the starting points of any subsequent zones. Also, if a valid reading is not attainable at a location within the zone due to a pothole, grass, occasional tracking, etc., move forward in the zone to the first available location for a valid reading, then resume the subsequent readings within that zone in the incremental procedure described above. However, readings will be taken in areas with substantial amounts of tracking.
- 3.5. For readings taken on centerlines, take alternating readings between solid lines or on the combination of solid and skip lines.
- 3.6. When a zone contains only skip lines for evaluation, measure each skip line at two evenly spaced locations on the line. Continue measuring within the established zone in this manner until 20 readings are obtained.
- 3.7. When a zone contains multiple line types of the same color and width, i.e. edgeline and lane line, obtain measurements representative of the quantities of line types.

4. PERFORMANCE REQUIREMENTS:

- 4.1. Retroreflectivity: The pavement marking will be evaluated for acceptance within the time period detailed in [sections 1.3 and 1.4](#).
- 4.2. If 80% (16 or more) of the readings in a zone meet or exceed the required minimum retroreflectivity values established for the materials that are being measured, the segment that is being evaluated will be accepted.
- 4.3. If less than 80% (less than 16) of the readings in a zone meet the required minimum retroreflectivity values established for the materials that are being measured, additional readings will be taken within the segment that is being evaluated.
- 4.4. Taking additional readings - Randomly establish two (2) new zones within the segment in question using the procedure detailed in section 3.2. Obtain readings for each of these zones as described in 3.2 –3.4. These readings will be combined with the initial readings for evaluation of the segment. If less than 80% of the 60 readings (20 in each of three zones) taken within a segment meet the minimum retroreflectivity requirements established

for the materials that are being measured, the segment is not accepted. Alternatively, if 13 or more of the first 20 readings taken within a segment fail to meet the minimum retroreflectivity requirements established for the materials that are being measured, the segment is not accepted and additional testing within that segment is not required.

4.5. If three of five segments are not accepted on a section of striping that is \geq 30 miles in length, the entire section of striping will not be accepted. If one segment is not accepted on a section of striping that is <30 miles in length, the entire section of striping will not be accepted.

5. REPORTING:

5.1. Include the following in the inspection report:

5.1.1. Printout of the readings taken with the hand-operated instrument (which should show date and time of test and zero reading and calibration). The readings shall be printed from either the on-board printer of the hand-operated instrument or an on-site printer linked directly to the hand operated instrument.

5.1.2. Date and time of application of the pavement marking from the Contractors Daily Striping Report

5.1.3. Location (County, route, milepoint, intersection, direction of travel, color of line, line type and any special information)

5.2. Record readings in millicandelas per square meter per lux (mcd/m²/lx).

5.3. Report measurements for each section of striping per color per line width per shift.

APPROVED Allen A. Myers
DIRECTOR
DIVISION OF MATERIALS

DATE 02/22/23

Kentucky Method 64-202-23
Revised 02/22/23
Supersedes KM 64-202-12
Dated 01/20/12

EVALUATION OF RETROREFLECTIVITY ON PERMANENT PAVEMENT MARKINGS USING MOBILE 30 METER GEOMETRY INSTRUMENTS

1. SCOPE:

- 1.1. This method covers the evaluation of retroreflectivity on permanent pavement markings using mobile 30-meter geometry instruments.
- 1.2. It is intended to provide standards of horizontal pavement markings to assure that adequate retroreflectivity for the driver is provided by newly applied markings.
- 1.3. Waterborne and durable waterborne pavement markings will be evaluated in a period of not less than 30 to no more than 60 days after the date the materials are applied.
- 1.4. Durable pavement markings such as Thermoplastic, Permanent Pavement Tapes, and Epoxies will be evaluated in a period of time not less than 150 days to no more than 210 days after the date the materials are applied.

2. TERMINOLOGY:

- 2.1. Section: a portion of striping completed for a single color per line width by one striping crew in one shift.
- 2.2. Segment: a portion equal to one-tenth of a mile of a section.
- 2.3. Retroreflectivity: a standard of measure for pavement markings. The units for these readings are millicandelas per square meter per lux ($\text{mcd}/\text{m}^2/\text{lx}$).
- 2.4. Crew: a group of two or more people identified by the striping crew and the driver of the striping crew applying pavement markings.
- 2.5. Shift: a period of time whereby a single crew works continuously stopping only for legally required breaks.

3. SUMMARY OF SPECIFICATION:

- 3.1. For the purpose of evaluating retroreflectivity, data obtained through evaluation according to KM 64-203 will be collected and evaluated separately for each section.
- 3.2. Calibrate the mobile instrument. Record calibration measurements at the beginning of the day's work. Recalibrate the instrument as necessary when taking readings. Provide the calibration measurements in the retroreflectivity report, each time these operations are performed.

3.3. The Department will provide the Contractor operating the mobile retroreflectometer with routes for evaluation. The routes evaluated will represent at least 50% of the segments completed in a section of striping. Data shall be collected in the direction the striper applied the traffic markings.

4. PERFORMANCE REQUIREMENTS:

4.1. Retroreflectivity: The pavement marking will be evaluated for acceptance within the time periods detailed in [sections 1.3. and 1.4.](#)

4.2. If 80% or more of the segments evaluated in a section meet or exceed the required minimum retroreflectivity values established for the materials that are being measured, the section will be accepted.

4.3. If less than 80% of the segments evaluated in a section meet the required minimum retroreflectivity values established for the materials that are being measured, the section will not be accepted.

5. REPORTING:

5.1. Include the following in the inspection report:

5.1.1. Calibration information for the mobile retroreflectometer.

5.1.2. Average of the readings taken for each segment evaluated by the mobile retroreflectometer (which should show date of test, total number of segments, passing segments, % passing segments, failing segments and % failing segments).

5.1.3. Date of application of the pavement marking.

5.1.4. Location (District, county, route, starting milepoint, ending milepoint, line type, direction of travel, color of line, and any special information).

5.2. Readings shall be recorded in millicandelas per square meter per lux ($\text{mcd}/\text{m}^2/\text{lx}$).

5.3. Measurement shall be reported for each section of striping per color per line width per shift.

APPROVED

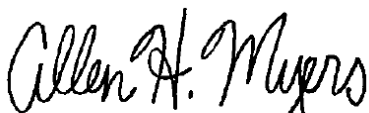

DIRECTOR
DIVISION OF MATERIALS

DATE

01/24/12

Kentucky Method 64-203-12

Revised 01/20/12

Supersedes KM 64-203-10

Dated 01/15/10

KM 64-203-12

PERFORMANCE BASED EVALUATION AND ACCEPTANCE
OF RETROREFLECTIVE SIGN SHEETING

1. SCOPE: This method outlines the process for submission of permanent and temporary retroreflective sign sheeting for approval by the Department for use on signs (regulatory, warning and guide), delineators, and channelization devices.
2. SUBMISSION:
 - 2.1. Permanent Retroreflective Sign Sheeting Submission Process:

Permanent Sign Sheeting shall be evaluated for three (3) years of performance data on the Virginia test deck of the National Transportation Product Evaluation Program (NTPEP) for Sign Sheeting Material. All permanent sign sheeting products submitted for the Department's approval must have a NTPEP Virginia Test Deck submittal year no earlier than four (4) years from the date of product submission.
 - 2.2. Temporary Retroreflective Sign Sheeting Submission Process:
 - 2.2.1 Barricade and Construction Sign Sheeting shall be evaluated for twelve (12) months of performance data on the NTPEP Virginia Test Deck for Sign Sheeting Material. Barricade and Construction Sign Sheeting submitted for the Department's approval must have a NTPEP Virginia Test Deck submittal year no earlier than two (2) years from the date of product submission.
 - 2.2.2 Roll Up Sign Sheeting shall be evaluated for twelve (12) months of performance data on NTPEP's Minnesota test deck for Roll Up Signing Material. Roll Up Sign Sheeting submitted for the Department's approval must have a NTPEP Minnesota Test Deck submittal year no earlier than two (2) years from the date of product submission.
3. APPROVAL PROCESS: A submitted sign sheeting material will be approved for use with each appropriate type and color if the material meets the minimum established performance criteria as defined by ASTM D4956 Standard Specification for Retroreflective Sheeting for Traffic Control. Retroreflective ratio minimums for multi-colored signs (herein referred to as a "sign sheeting system") must meet the criteria described in Section 2A-08, Table 2A-3, of the current Manual on Uniform Traffic Control Devices (MUTCD). All retroreflective values are assessed at a 0.2° observation angle and a -4.0° entrance angle. Additionally, all sign sheeting material in the sign sheeting system must be from the same manufacturer and be identified by a product name.

3.1. Permanent Sign Sheeting

NOTE: Types III, IV and IX permanent sign sheeting are being phased out. New products will not be added to these categories on the Department's List of Approved Materials (LAM) in the future.

3.1.1. Type XI: Retroreflective sign sheeting utilizing non-metallic microprismatic retroreflective elements as the retroreflective material to provide very high-intensity retroreflectivity at short road distances that meets the minimum performance criteria established by the Department.

3.1.2. Type XI sign sheeting allows for the following colors on the LAM: blue, brown, fluorescent yellow, fluorescent yellow-green, green, red, white and yellow.

3.2. Construction Sign Sheeting

3.2.1. Types IV, VIII, IX, and XI: Retroreflective sign sheeting utilizing non-metallic microprismatic retroreflective elements as the retroreflective material to provide very high-intensity retroreflectivity at short road distances that meets the minimum performance criteria established by the Department.

3.2.2. Types IV, VIII, IX and XI sign sheeting allows for the following color on the LAM: fluorescent orange.

3.3. Roll-Up Sign Sheeting

3.3.1. Type VI: Retroreflective sign sheeting used without adhesive that utilizes vinyl microprismatic retroreflective material to provide elastomeric high-intensity retroreflectivity that meets the minimum performance acceptance criteria established by the Department. Type VI sign sheeting materials are acceptable for use as temporary highway signing.

3.3.2. Type VI sign sheeting allows for the following color on the LAM: fluorescent orange.

3.4. Delineators

3.4.1. Type XI: Retroreflective sign sheeting utilizing non-metallic microprismatic retroreflective elements as the retroreflective material to provide very high-intensity retroreflectivity at short road distances that meets the minimum performance acceptance criteria established by the Department.

3.4.2. Type XI sign sheeting allows for the following colors on the LAM for delineator applications: fluorescent yellow, red, and white.

3.5. Barricade Sign Sheeting

3.5.1. Type III: Retroreflective sign sheeting utilizing encapsulated glass beads as the retroreflective material to provide high-intensity retroreflectivity that meets the minimum performance acceptance criteria established by the Department.

3.5.2. Type IV: Retroreflective sign sheeting utilizing non-metallic microprismatic retroreflective elements as the retroreflective material to provide high-intensity retroreflectivity that meets the minimum performance acceptance criteria established by the Department.

3.6. Drums, Cones and Tubular Markers

3.6.1. Types III, IV, VIII, IX, and XI: Retroreflective sign sheeting utilizing non-metallic microprismatic retroreflective elements as the retroreflective material to provide very high-intensity retroreflectivity at short road distances that meets the minimum performance acceptance criteria established by the Department.

3.6.2. Types III, IV, VIII, IX, and XI sign sheeting allows for the following colors on the LAM for drum, cone, and tubular marker applications: fluorescent orange, orange, and white.

4. REMOVAL PROCESS: Sign sheeting materials may be removed from the LAM based on any of the following requirements. Sign sheeting systems removed from the LAM shall not be eligible for re-submission for three (3) calendar years from the date of removal.

4.1. Verification Testing: Rejection of any three (3) lots of any product within a single calendar year shall constitute grounds for removal.

Appropriate properties shall be verified for compliance in accordance with criteria set forth by ASTM D4956 and Section 2A.08 of the MUTCD. The manufacturer shall be notified in writing of every product rejection.

4.2. Requalification Review

4.2.1. Permanent Retroreflective Sign Sheeting

4.2.1.1. Failure to re-submit a product to NTPEP every six (6) years for compliance with the established acceptance criteria shall constitute grounds for removal.

4.2.1.2. Product data that is more than four (4) years old shall not be used to verify compliance.

4.2.1.3. If data from the NTPEP Virginia Test deck is not complete by year six (6) of a product's tenure on the LAM, but submission for re-approval has been completed, the material may remain on the LAM up to year nine (9) after the original approval.

4.2.1.4. If re-approval submission of a product has been completed but the NTPEP Virginia Test Deck data is not complete by year nine (9), then the product shall be removed from the list at year nine (9).

4.2.1.5. If re-approval submission has been completed to NTPEP's Virginia Test Deck but the data does not comply with ASTM D 4956 and Section 2A.08 of the MUTCD, then the product shall be removed from the list at year nine (9).

4.2.2. Temporary Retroreflective Sign Sheeting

4.2.2.1. Failure to re-submit a product to NTPEP every three (3) years for compliance with the established acceptance criteria shall constitute grounds for removal.

4.2.2.2. Product data that is more than two (2) years old shall not be used to verify compliance.

4.2.2.3. If data from the appropriate test deck is not complete by year two (2) of a product's tenure on the LAM, but submission for re-approval has been completed, the material may remain on the LAM up to year four (4) after the original approval.

4.2.2.4. If re-approval submission of a product has been completed, but the test deck data is not complete by the end of year three (3), then the product shall be removed from the list by year four (4).

4.2.2.5. If re-approval submission has been completed to the appropriate test deck but the data does not comply with ASTM D 4956 and Section 2A.08 of the MUTCD, then the product shall be removed from the list at year four (4).

4.3. Field Performance Evaluation: Failure of the sign sheeting material to remain applied or failure of the sign sheeting material to provide suitable retroreflectivity, color and luminance may constitute grounds for removal.

APPROVED

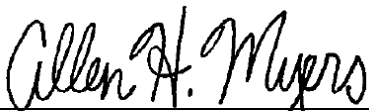

DIRECTOR
DIVISION OF MATERIALS

DATE

03/29/21

Kentucky Method 64-204-21
Revised 03/29/21
Supersedes KM 64-204-20
Dated 05/06/20

PERFORMANCE BASED EVALUATION AND ACCEPTANCE
OF PAVEMENT MARKERS

1. **SCOPE:** This method outlines the process for submission of non-plowable and plowable pavement markers for use on new construction or maintenance projects as deemed appropriate by the Department.
2. **SUBMISSION:**
 - 2.1. **Snow Plowable Raised Pavement Markers** – Type IV lenses for use in Type V iron castings or lenses installed in grooves as inlaid markers with a bitumen adhesive base (as applicable) will be evaluated as a system through the National Transportation Evaluation Program (NTPEP) on the Ohio test deck.
 - 2.2. **Non-Plowable Raised Pavement Markers** – Type IVA Surface mounted lenses and bituminous adhesive shall be evaluated as a system for temporary use in work zones through the National Transportation Product Evaluation Program (NTPEP) on the Georgia test deck for a period of twelve months.
3. **APPROVAL PROCESS:** A submitted product will be given approval for each appropriate category that meets the minimum established performance criteria.

3.1. Snow Plowable Raised Pavement Markers

3.1.1. Dimensions

3.1.1.1. Retroreflective Marker – Shall have a maximum width of 102mm (4 in.), a flat base within 1.3mm (0.05in.) with an angle between the face of the markers and the base no greater than 45°

3.1.1.2. Iron Holder – Shall have a maximum height of 10.9mm (0.43in.) above the road surface, with deflecting ramps angled not more than 6° to the surface of the road.

3.1.2. Compressive Strength – Shall support a load of 6,000 lbf without breakage or significant deformation of the marker.

3.1.3. Lens Impact Strength – Shall show no radial cracks or delamination.

3.1.4. Resistance to Temperature Cycling – Shall show no radial cracks or delamination.

3.1.5. Color – Conform to ASTM D 4383.

3.1.6. Temperature Cycling – Shall have no detectable radial cracks or delamination.

3.1.7. Coefficient of Luminous Intensity – Shall conform to the following minimums

	Entrance Angle	Observation Angle	White (mcd/lx)	Yellow (mcd/lx)	Red (mcd/lx)
12 Mo. Evaluation	0°	0.2°	279	167	70
12 Mo. Evaluation	+20°/-20°	0.2°	112	67	28
	Entrance Angle	Observation Angle	White (cd/fc)	Yellow (cd/fc)	Red (cd/fc)
12 Mo. Evaluation	0°	0.2°	3.0	1.8	0.75
12 Mo. Evaluation	+20°/-20°	0.2°	1.2	0.72	0.30

3.1.8. Rockwell C Hardness – Shall obtain an average between 51-55 HRC1.

3.1.9. Field Evaluation of Marker Cases and Lens Surfaces – Shall have the following minimum ratings after 12 months of evaluation:

	Casting	Lens	Nighttime Visibility
Asphalt	5	3	3
Concrete	5	3	3

3.2. Non-Plowable Raised Pavement Markers

3.2.1. Dimensions

3.2.1.1. Maximum height of 20.3 mm (0.80 in)

3.2.1.2. Maximum width of 130mm (5.1 in.) with the angle between the face of the marker and the base no greater than 45°

3.2.1.3. Marker front shall have no protuberance of more than 1mm (0.04 in)

3.2.1.4. Base shall be flat within 1.3 mm (0.05 in)

3.2.2. Compressive Strength – Shall support a load of 6,000 lbs without breakage or significant deformation of the marker.

3.2.3. Flexural Strength – Shall withstand 8914 N (2000 lbf) without breakage

3.2.4. Lens Impact strength – Shall show no radial cracks, delamination, or indentation.

3.2.5. Resistance to Temperature Cycling – Shall show no radial cracks or delamination.

3.2.6. Color – Shall conform to ASTM D 4280

3.2.7. Abrasion Resistance - Shall conform to the following minimum coefficient of luminous intensity after abrasion:

	Entrance Angle	Observation Angle	White (cd/fc)	Yellow (cd/fc)	Red (cd/fc)
12 Mo. Evaluation	0°	0.2°	1.5	0.9	0.38
12 Mo. Evaluation	+20°/-20°	0.2°	0.6	0.36	0.15

3.2.8. Coefficient of Luminous Intensity– Shall conform to the following minimums:

	Entrance Angle	Observation Angle	White (cd/fc)	Yellow (cd/fc)	Red (cd/fc)
12 Mo. Evaluation	0°	0.2°	3.0	1.8	0.75
12 Mo. Evaluation	+20°/-20°	0.2°	1.2	0.72	0.30

3.2.9. Adhesive Bond Strength –99% of the markers must remain bonded to the pavement at the end of the 24 month evaluation cycle.

3.2.10. Field evaluation of the lens surfaces – shall conform to the following table at 12 months:

	Lens Surface
Asphalt	100% rate 5
Concrete	100% rate 5

4. REMOVAL PROCESS: Raised Pavement Markers may be removed from the Department’s List of Approved Materials based on any of the following requirements.

- 4.1. Requalification Testing: Any product on the Department’s List of Approved Materials may be removed from this list after five years unless they are submitted to NTPEP for re-evaluation and meet the criteria detailed above.
- 4.2. Field Performance Evaluation: Failure of the raised pavement marker to maintain retroreflectivity or adhesion may result in removal from the Department’s List of Approved Materials.
- 4.3. Material Warranty: Failure of the manufacture to provide replacement material for any material under warranty may result in removal from the Department’s List of Approved Materials.

APPROVED Allen H. Myers
 DIRECTOR
 DIVISION OF MATERIALS

DATE 04/07/20

Kentucky Method 64-444-17
 Dated 04/07/20

PERFORMANCE BASED EVALUATION AND ACCEPTANCE
OF PAVEMENT MARKING MATERIALS

1. SCOPE: This method outlines the process for submission of pavement marking materials for approval for use on new construction or maintenance projects as deemed appropriate by the Department.
2. SUBMISSION: Data shall be evaluated as follows every four (4) years. Data that is more than eight (8) years old at the time of review shall not be evaluated.
 - 2.1 Category I - Preformed Thermoplastics Submission Process:

Preformed Thermoplastics shall be evaluated for performance through the National Transportation Product Evaluation Program (NTPEP) for Pavement Marking Materials. The Pennsylvania asphalt test deck shall be used for evaluation.
 - 2.2 Category II - Construction Zone Non-Removable (Foil Back) and Removable Temporary Tape Submission Process:

Temporary Tapes shall be evaluated for performance through the National Transportation Product Evaluation Program (NTPEP) for Pavement Marking Materials. The Pennsylvania asphalt and concrete test deck shall be used for evaluation.
 - 2.3 Category III – Durable Preformed Pavement Markings Type I Tape Submission Process:

Type I Tape shall be evaluated for performance through the National Transportation Product Evaluation Program (NTPEP) for Pavement Markings Materials. The Pennsylvania concrete test deck shall be used for evaluation.
3. APPROVAL PROCESS: A submitted product will be given approval for each appropriate category that meets the minimum established performance criteria.
 - 3.1 Category I
 - 3.1.1 White Retroreflectivity: 300 mcd/m²/lux minimum after five (5) months (skip) and 200 mcd/m²/lux after 12 months (skip).
 - 3.1.2 Yellow Retroreflectivity: 225 mcd/m²/lux minimum after five (5) months (skip) and 100 mcd/m²/lux after 12 months (skip).
 - 3.1.3 Durability: Rating of 9 after 12 months (skip and wheel).
 - 3.1.4 Color: Chromaticity coordinates reported for a period of 12 months shall fall within the chromaticity boundaries described by the four corner points established by the coordinated adopted by ASTM D-6628 for each month they are reported.

3.1.5 Luminance: Y Tristimulus coordinates reported for a period of 12 months shall conform to requirements found in ASTM D-6628.

3.1.6 Applied Thickness: Product must be applied at a minimum 125 mils.

3.2 Category II

3.2.1 Construction Zone Non-Removable (Foil Back) Temporary Tape

3.2.1.1 Average Retroreflectivity – Transverse

3.2.1.1.1 White Retroreflectivity: 300 mcd/m²/lux average minimum initially (skip and left wheel) and 300 mcd/m²/lux average minimum at six months (skip).

3.2.1.1.2 Yellow Retroreflectivity: 225 mcd/m²/lux average minimum initially (skip and left wheel) and 225 mcd/m²/lux average minimum at six months (skip).

3.2.1.2 Average Retroreflectivity – Longitudinal

3.2.1.2.1 White Retroreflectivity: 300 mcd/m²/lux average minimum initially (skip) and 300 mcd/m²/lux average minimum at six months (skip).

3.2.1.2.2 Yellow Retroreflectivity: 225 mcd/m²/lux average minimum initially (skip) and 225 mcd/m²/lux average minimum at six months (skip).

3.2.1.3 Color: The chromaticity coordinates reported for the evaluation period shall fall in the chromaticity boundaries described by the four corner points established by the coordinates adopted by ASTM D-6628 for each month they are reported.

3.2.2 Construction Zone Removable Temporary Tape

3.2.2.1 Average Retroreflectivity – Transverse

3.2.2.1.1 White Retroreflectivity: 300 mcd/m²/lux average minimum initially (skip and left wheel) and 300 mcd/m²/lux average minimum at six months (skip).

3.2.2.1.2 Yellow Retroreflectivity: 225 mcd/m²/lux average minimum initially (skip and left wheel) and 225 mcd/m²/lux average minimum at six months (skip).

3.2.2.2 Average Retroreflectivity – Longitudinal

3.2.2.2.1 White Retroreflectivity: 300 mcd/m²/lux average minimum initially (skip) and 300 mcd/m²/lux average minimum at six months (skip).

3.2.2.2.2 Yellow Retroreflectivity: 225 mcd/m²/lux average minimum initially (skip) and 225 mcd/m²/lux average minimum at six months (skip).

3.2.2.3 Internal Tape Strength: During each month of evaluation, the longitudinal and transverse stripes shall retain a subjective rating from 1 to 5 when removed by hand without the use of heat, grinder or other equipment from asphalt or concrete.

3.2.2.4 Adhesive Bond Strength: During each month of evaluation, the longitudinal and transverse stripes shall retain a subjective rating from 1 to 5 when the material is removed by hand without the use of heat, grinder or other equipment from asphalt and a subjective rating from 1 to 7 when the material is removed by hand without the use of heat, grinder or other equipment from concrete.

3.2.2.5 Color: Chromaticity coordinates reported for a period of 12 months shall fall within the chromaticity boundaries described by the four corner points established by the coordinated adopted by ASTM D-6628 for each month they are reported.

3.2.2.6 Luminance: Y Tristimulus coordinates reported for a period of 12 months shall conform to requirements found in ASTM D-6628.

3.3 Category III

3.3.1 White Retroreflectivity: 500 mcd/m²/lux average minimum initially (skip and wheel) and 100 mcd/m²/lux average minimum at 24 months (skip).

3.3.2 Yellow Retroreflectivity : 500 mcd/m²/lux average minimum initially(skip and left wheel) and 100 mcd/m²/lux average minimum at 24 months (skip).

3.3.3 Durability: Retain a rating of 10 on both the skip and the wheel during the initial evaluation and retain a rating of 8 or higher on both the skip and the wheel at 24 months.

3.3.4 Color: Chromaticity coordinates reported for a period of 12 months shall fall within the chromaticity boundaries described by the four corner points established by the coordinated adopted by ASTM D-6628 for each month they are reported.

3.3.5 Luminance: Y Tristimulus coordinates reported for a period of 12 months shall conform to requirements found in ASTM D-6628.

3.3.6 Applied Thickness: Product must be applied at a minimum 90 mils on the test deck for qualification. Products will be approved at the actual mils applied on the NTPEP test deck and must supply that product to the Commonwealth of Kentucky.

4. REMOVAL PROCESS: Pavement marking materials may be removed from the Department's List of Approved Materials based on any of the following requirements.
- 4.1 Requalification Testing: All products will be removed from this list after eight (8) years unless they are submitted to NTPEP for re-evaluation and meet the criteria detailed above.
 - 4.2 Field Performance Evaluation: Failure of the pavement marking materials to be suitably applied within the recommendations of the manufacturer or failure of the material to maintain retroreflectivity, color or adhesion.
 - 4.3 Material Warranty: Failure of the manufacture to provide replacement material for any material under warranty.

APPROVED

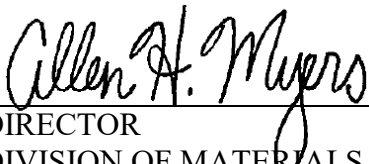

DIRECTOR
DIVISION OF MATERIALS

DATE

08/23/19

Kentucky Method 64-207-19
Dated 08/23/19

PULL-OUT TEST FOR RE-BAR ANCHOR SYSTEMS

1. SCOPE:

- 1.1. This test method outlines the procedure for determining the laboratory pull-out strength of non-epoxy grout adhesives by measuring the force required to pull a bonded rebar from a concrete block. Non-epoxy grout adhesives are classified according to cure time; Category I cures in one hour and Category II cures in 24 hours.
- 1.2. This test method also outlines the procedure for determining the pull-out strength of rebars at the job site.

2. APPARATUS-MATERIALS:

- 2.1. Tinius Olsen Hydraulic Tension Testing Machine, which is calibrated periodically in accordance with the latest revision of AASHTO T67 Verification of Testing Machines.
- 2.2. Three #5 epoxy coated rebar measuring 24 inches, or longer in length.
- 2.3. Three hardened concrete test blocks measuring 10"x10"x10" and with $f'_c = 4000$ psi at 28 days.
- 2.4. Hook-Bolt Testing Equipment consisting of hydraulic ram and pump and associated hardware.
- 2.5. Load cell indicator with a minimum capacity of 36,000 pounds.

3. LABORATORY PROCEDURES:

- 3.1. A dowel hole shall be drilled into the center of each concrete test block, measuring 6 inches in depth and 3/4 of an inch in diameter.
- 3.2. The dowel holes shall be cleaned of all drill or coring dust with water and/or air injected under pressure and then permitted to air dry.
- 3.3. Fill the dowel holes with the adhesive in accordance with the manufacturer's instructions.
- 3.4. Insert the rebar to the bottom of the dowel hole and twist 1/4 turn.
- 3.5. An excess amount of adhesive must be clearly visible as an extruded ring of material surrounding the steel bar at the surface of the concrete.
- 3.6. Allow the adhesive to cure for one hour and 24 hours respectively for Category I and II materials.

- 3.7. Place the load cell in the Tinius Olsen test apparatus and calibrate the load cell at 19,000 pounds test load.
- 3.8. Install the raised base over the rebar and lower to the surface of the concrete block. Then place the hydraulic ram over the rebar until it rests on the raised base.
- 3.9. Next, install a steel plate, the load cell, and another steel plate. Finally, install the wedge chuck on the rebar leaving approximately one inch clearance between the chuck and ram. This will provide space for the chuck to be removed after the test load is released.
- 3.10. After checking to see that all items are in the proper position, raise the ram by activating the hand pump until contact is made by the ram with the wedge chuck.
- 3.11. Apply a tensile load of 19,000 pounds to the rebar. The rebar shall withstand the applied load with zero slippage.
- 3.12. Slowly release the proof load and remove the test equipment in reverse order used for installation.

4. FIELD PROCEDURES:

- 4.1. The rebars to be tested for pull-out strength shall be randomly selected.
- 4.2. The surface of the concrete around the rebar shall be reasonably flat to permit proper support for the raised base used to support the hydraulic ram.
- 4.3. Repeat steps 3.8 through 3.10. If necessary, separate the rebar by sawing or flame cutting. Apply a tensile load as indicated below to the rebar. The rebar shall withstand the applied load with zero slippage.

REBAR SIZE (#)	PROOF LOAD (Pounds)
3	7,000
4	12,000
5	19,000
6	27,000
7	36,000

- 4.5. Repeat step 3.12.

5. REPORT:

5.1. Amount of slippage, if any.

5.2. Concrete breakage, if any.

5.3. Pull-out strength in pounds.

APPROVED

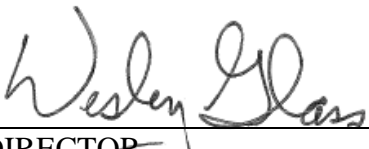

DIRECTOR
DIVISION OF MATERIALS

DATE

04/18/08

Kentucky Method 64-209-08
Revised 04/18/08
Supersedes KM 64-209-02
Dated 12/26/02

Kentucky Method 64-210-08
Revised 03/07/08
Supersedes KM 64-210-02
Dated 12/26/02

CHLORIDE CONTENT (CONCRETE ADMIXTURES)

1. SCOPE: This method is used to determine the chloride content of admixtures used in concrete.
2. APPARATUS AND MATERIALS:
 - 2.1. pH Meter and chloride-ion selective electrode.
 - 2.2. HNO₃, 1:6
 - 2.3. Standard 0.01N AgNO₃: Standardize with 20 ml of 0.01N NaCl Solution.
 - 2.4. Standard 0.01N NaCl: Dry reagent grade NaCl in an oven at 105 °C. Cool and weigh out 0.5844 grams. Dissolve in distilled water, and transfer to a 1 liter volumetric flask. Dilute to 1 liter with distilled water, and mix well.
3. PROCEDURE:
 - 3.1. Weigh a 1 - 2 gram sample into a 250 ml beaker, and dilute to 150 ml with distilled water. Add a few drops of HNO₃. Titrate with standard AgNO₃ solution, recording volumes added and millivolt readings. Enough AgNO₃ solution should be added to cause a readable change in millivolts. The endpoint is determined by finding the biggest deviation in millivolt readings.
 - 3.2. Alternate Method - Weigh a 1 - 2 gram sample into a 250 ml beaker, and dilute to 150 ml with distilled water. Add a few drops of HNO₃. Set the Fisher Electrometer Model 380 to 0 millivolt using distilled water. Titrate the sample to 0 millivolt.

4. CALCULATIONS:

$$\frac{35.453 \times \text{ml} \times N \text{ AgNO}_3}{10 \times \text{Sample Wt.}} = \% \text{ Chloride}$$

5. REPORT: Percent chloride present in sample.

APPROVED



DIRECTOR
DIVISION OF MATERIALS

DATE

03/07/08

Kentucky Method 64-210-08
Revised 03/07/08
Supersedes KM 64-210-02
Dated 12/26/02

Kentucky Method 64-221-08
Revised 05/09/08
Supersedes KM 64-221-03
Dated 01/16/03

AGRICULTURAL LIMESTONE

1. SCOPE: This method outlines the procedure for testing either agricultural limestone, or limestone ground to pass a No. 100 sieve.
2. APPARATUS – MATERIALS:
 - 2.1. No. 10, No. 50 Sieves.
 - 2.2. Hydrochloric Acid.
 - 2.3. Sodium Hydroxide.
 - 2.4. Phenolphthalein.
3. PROCEDURE:
 - 3.1. Sample Preparation: The sample is usually received in a quart can, or in a bag. If the sample is not dry, it must be dried before any tests are performed. This may be done by splitting the sample and drying in an oven at 110 °C for 1 - 1½ hours. When the sample is dry, let it cool to room temperature.
 - 3.2. Sieve Analysis: Perform sieve analysis in accordance with AASHTO T27 Sieve Analysis of Fine and Coarse Aggregates.
 - 3.3. Calcium Carbonate Equivalent: Grind sample to pass No. 50 sieve, and mix thoroughly. Place 1 gram ground sample in 250 ml Erlenmeyer flask. Add 50 ml of 0.5 N HCl (standard solution), and boil gently for 5 minutes. Cool, and titrate excess acid with 0.25 N NaOH (standard solution) using phenolphthalein.

4. CALCULATIONS:

$$\frac{5(V_1N_1 - V_2N_2)}{W_1} = \% \text{ CaCO}_3 \text{ Equivalent}$$

V₁ = Volume of HCl

V₂ = Volume of NaOH

N₁ = Normality of HCl

N₂ = Normality of NaOH

W₁ = Sample weight

5. REPORT:

5.1. % Passing 2000 μm (No. 10) Sieve, to the Whole Number [100 mesh only]

5.2. % Passing 300 μm (No. 50) Sieve, to the Whole Number [100 mesh only]

5.3. CaCO_3 Equivalent

APPROVED 

DIRECTOR
DIVISION OF MATERIALS

DATE 05/09/08

Kentucky Method 64-221-08

Revised 05/09/08

Supersedes KM 64-221-03

Dated 01/16/03

CALCIUM CHLORIDE

1. SCOPE: This test method covers calcium chloride to be used for road conditioning purposes. Unless otherwise specified, calcium chloride may be furnished in either of two types.

Type 1 Regular flake calcium chloride.
Type 2 Concentrated flake, pellet, or other granular forms.
2. APPARATUS AND MATERIALS:
 - 2.1. Sieve sizes 3/8", No. 4 and No. 30.
 - 2.2. Hydrochloric Acid.
 - 2.3. Ammonium Hydroxide.
 - 2.4. Ammonium Chloride (20 gm/liter).
 - 2.5. Ammonium Oxalate (saturated sol.).
 - 2.6. Methyl Red Indicator.
3. SAMPLE: Sample in accordance with the [Cabinet's Sampling Manual on Calcium and Sodium Chloride](#). Calcium chloride samples are received in quart metal containers. Care must be taken to keep the container covered at all times, except when portions are being removed for tests.
4. PROCEDURES:
 - 4.1. The sieves used in this determination are the 3/8", No. 4, No. 30 and Pan stacked in that order. Weigh 100 grams to 0.1 gm as rapidly as accuracy will permit, and pour onto the 3/8" sieve. Shake the entire stack and pan for one minute using a circular motion with frequent tapping. Weigh the fraction to 0.1 gm. Starting with the pan, and record as percent passing the No. 30 sieve. To this amount, add the fraction retained on the No. 30 sieve as the percent passing the No. 4 sieve. Repeat procedure until each fraction is weighed and recorded. Any moisture that may have formed on the sieves should be removed so that the sieve will be dry and clean for the next determination.
 - 4.2. Chemical Analysis:
 - 4.2.1. Total Calcium:
 - 4.2.1.1. Weigh accurately in a weighing bottle a sample of approximately 5 gm., and dissolve in distilled water. Add a drop or two of HCl to clear up solution, and dilute to 500 ml in a volumetric flask. Mix

thoroughly. Pipette a 25 ml. Aliquot, and transfer to a 400 ml beaker. Add 3 drops of methyl red, and make slightly alkaline by adding NH₄OH (1:1). Add 20 ml of saturated NH₄CL solution. Dilute to a volume of 100 to 150 ml. Heat to boiling, and carefully add 40 ml of hot (NH₄)₂C₂O₄ solution while stirring. Continue boiling for 3 to 5 minutes with occasional stirring to prevent bumping.

4.2.1.2. Remove from hot plate, and let settle for at least 30 minutes. Filter on No. 42 filter paper, taking care not to fill funnel more than ¾ full at any time. Wash precipitate with cold water. From this point, calcium may be determined either gravimetrically or volumetrically.

4.2.2. Gravimetric: Place paper and precipitate in a pre-weighed porcelain crucible, and char on hot plate. Ignite sample in a muffle furnace at 950 °C for at least one hour. Cool in dessicator, and re-weigh.

4.2.3. Volumetric: Return precipitate and filter paper to original beaker. Add 25 ml of H₂SO₄ (1:4) and macerate the filter paper with a glass rod. Dilute to 100-150 ml, and heat to about 80° C. While still hot, titrate to a faint pink with 0.1 N KmnO₄.

4.2.4. Calculations:

Gravimetric = Wt. of Ash x 791.68 = %CaCl₂

Volumetric:

$$\frac{mL\ of\ 0.1\ N\ KMnO_4 \times 11.1}{Wt.\ of\ Original\ Sample} = \%CaCl_2$$

5. CALCULATIONS: Calculations as indicated in Procedures.
6. PRECAUTIONS: Handle Calcium Oxalate precipitate in the same manner as in [Agricultural Limestone Procedure](#).
7. REPORT: % Calcium Chloride.

APPROVED

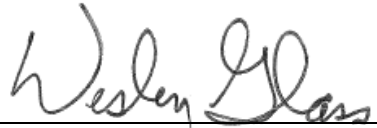

DIRECTOR
DIVISION OF MATERIALS

DATE

05/09/08

Kentucky Method 64-222-08
Revised 05/09/08

Kentucky Method 64-224-08
Revised 03/13/08
Supersedes KM 64-224-03
Dated 01/16/03

CHEMICAL ANALYSIS OF LIMESTONE, FINE AGGREGATE,
QUICKLIME AND HYDRATED LIME

1. SCOPE: This test method covers aggregate intended for use in various highway construction projects. Chemical analysis of aggregates are required only when specified on plans, proposals, bidding invitations, or by special provisions covering any particular material or projects. This method is a modification of ASTM C-25 for the chemical testing of limestone, fine aggregate, quicklime and hydrated lime by x-ray spectroscopy.
2. APPARATUS AND MATERIALS:
 - 2.1. Wet Chemical: All wet chemical analysis will be performed in accordance with ASTM C-25 current edition.
 - 2.1.1. 30ml Porcelain crucible
 - 2.1.2. Balance: capable of accurately weighing to 0.0001g
 - 2.1.3 Oven: maintained at 110°C
 - 2.1.3. Muffle furnace: maintained at 950°C
 - 2.1.4. Dessicator
 - 2.2. X-Ray Fluorescence:
 - 2.2.1. Philips MagiX PRO Wavelength Dispersive X-Ray Fluorescence Spectrometer
 - 2.2.2. SuperQ software
 - 2.2.3. Philips Perl'x 3 fused bead machine
 - 2.2.4. Platinum dish and crucible set
 - 2.2.5. Lithium Bromide (LiBr) – 10% solution non-wetting agent
 - 2.2.6. 67% Lithium Tetraborate ($\text{Li}_2\text{B}_4\text{O}_7$):33% Lithium Metaborate (LiBO_2) flux
 - 2.2.7. Lithium Tetraborate ($\text{Li}_2\text{B}_4\text{O}_7$) flux
 - 2.2.8. 27mm Steel sample cup and insert

3. PROCEDURE:

3.1. Prepare moisture free sample.

3.1.1. Prepare porcelain crucibles by igniting in a muffle furnace at 950°C to constant weight. Cool and store crucibles in a desiccator to avoid absorption of moisture

3.1.2 Weigh approximately 2 grams of sample into a prepared porcelain crucible.

3.1.3. Dry the sample to a constant weight in an oven at 110°C.

3.1.4. Cool the sample to room temperature in a desiccator to avoid absorption of moisture. DO NOT DISCARD the sample.

3.2. Determine loss on ignition (LOI) by weight percent.

3.2.1. Weigh approximately 1 gram of original sample into a prepared porcelain crucible. Record the sample weight to the nearest 0.0001g.

3.2.2. Ignite sample to a constant weight in a muffle furnace at 950°C and cool in a desiccator.

3.2.3. Re-weigh the cooled sample. DO NOT DISCARD the sample. Record the ignited sample weight to the nearest 0.0001g.

3.2.4. Calculate the loss on ignition (LOI) in accordance with [Section 4.1](#).

3.3. Prepare and analyze aggregate sample (limestone or fine aggregate).

3.3.1. Weigh 6.0g to the nearest 0.0001g of 67% $\text{Li}_2\text{B}_4\text{O}_7$:33% LiBO_2 flux directly into platinum crucible.

3.3.2. Weigh 0.6g to the nearest 0.0001g of aggregate sample retained from 3.1 directly into the platinum crucible.

3.3.3. Add 3 drops of LiBr solution to the sample.

3.3.4. Place the platinum crucible and dish in the Perl'x 3 machine and select to run program 9 ([Note 5.1](#)).

3.3.5 Access SuperQ software and open the ledrock application.

3.3.6 Enter the sample identification and LOI in the measure sample screen of the measure and analyze program.

3.3.7 Place the prepared sample into a 27mm steel cup and load into the x-ray instrument.

3.3.8 Click measure at the bottom of the measure and analyze screen ([Note 5.2](#)).

3.4 Prepare and analyze lime sample (hydrated lime or quicklime).

3.4.1. Weigh 6.0g to the nearest 0.0001g of $\text{Li}_2\text{B}_4\text{O}_7$ flux directly into platinum crucible.

- 3.4.2. Weigh 0.6g to the nearest 0.0001g of lime sample retained from 3.2 directly into the platinum crucible.
- 3.4.3. Add 3 drops of LiBr solution to the sample.
- 3.4.4. Place the platinum crucible and dish in the Perl'x 3 machine and select to run program 9 (Note 5.1).
- 3.4.5 Access SuperQ software and open the lime application.
- 3.4.6 Enter the sample identification and LOI in the measure sample screen of the measure and analyze program.
- 3.4.7 Place the prepared sample into a 27mm steel cup and load into the x-ray instrument.
- 3.4.8 Click measure at the bottom of the measure and analyze screen (Note 5.2).

4. CALCULATION:

4.1 $LOI = (A/B) \times 100$

where: A = weight of sample after ignition.
 B = weight of original sample.

5. NOTES:

- 5.1 Program 9 includes: One oxidation for 2 minutes, temperature 1100°C, generator power 77, agitation angle 25, and agitation speed 10. One fusion for 6 minutes, temperature 1100°C, generator power 77, agitation angle 50, and agitation speed 15. Then a pause before casting for 10 seconds at a temperature of 1100°C. Casting time 2 minutes, temperature 1100°C, casting angle 123, casting speed 10, and time for solidification 30 seconds. Lastly there is natural air cooling for 1 minute and forced air cooling for 3 minutes at a flow rate of 40. The setting of the dish height dial is 40/12 and is dependent on the size of the platinum dish being used.
- 5.2 Program quantifies data by using a least squares program. Similar samples with known chemical analyses are used as standards in the quantification technique. As many standards as possible are used for best quantification. The results are reported as oxides in weight percents.

6. REPORT:

- 6.1. Report the following values for aggregate samples.
 - 6.1.1. % Silica: upon request only
 - 6.1.2. % Combined Oxides for all except "silica" sand. ($Al_2O_3 + TiO_2 + MnO + Fe_2O_3$)
 - 6.1.3. % $CaCO_3$: for all except "silica" sand
 - 6.1.4. % $MgCO_3$: for all except "silica" sand

6.1.5. % CaO: for slags only

6.1.6. % MgO: for slags only

6.1.7. SiO₂

6.1.8. % Ca

6.1.9. % Mg

6.1.10. % LOI

6.2. Report the following values for lime samples.

6.2.1. % CaO

6.2.2. % MgO

APPROVED

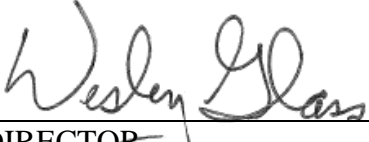

DIRECTOR
DIVISION OF MATERIALS

DATE

03/13/08

Kentucky Method 64-224-08
Revised 03/13/08
Supersedes KM 64-224-03
Dated 01/16/08

SODIUM CHLORIDE

1. SCOPE: This test method outlines the procedure for testing sodium chloride to be used for road conditioning purposes.
2. APPARATUS AND MATERIALS:
 - 2.1. 1/2", 3/8", No.4, No. 8, and No. 30 Sieves.
 - 2.2. Calcium Chloride
 - 2.3. Dextrin Solution (2%)
 - 2.4. Dichlorofluorescein Indicator (0.1%)
 - 2.5. Silver Nitrate (0.1N)
 - 2.6. Iron Mortar and Pestle
 - 2.7. Nitric Acid (conc.)
3. PROCEDURE:
 - 3.1. Sieve Analysis: Pour entire sample through sand splitter, and reserve one of the two portions obtained. Repeat splitting until only about enough of one split portion remains to fill partially a 120 ml (4 oz.) sample bottle. Also weigh 100 g of the discard portions, and pour sample onto the top sieve of a stack which contains in order, 1/2", 3/8", No.4, No. 8, and No. 30 Sieves and Pan. Shake the entire stack with a circular motion and occasional gentle tapping for 2 - 3 minutes. Carefully remove sieves from the stack, starting with the pan, and weigh the size fractions. By leaving fractions in the weighing pan, the percent passing each sieve can be read directly from the balance without calculations.
 - 3.2. Sodium Chloride Determinations:
 - 3.2.1. Pulverize 25 - 30 grams of the sample in the 120 ml (4 oz.) bottle using iron mortar and pestle, or electrically powered grinder, and transfer to a weighing bottle. If there is evidence of moisture in the sample, it should be placed in a drying oven for 1 - 2 hours at a temperature of 100° to 150 °C. Remove from the oven, and cool in dessicator. Carefully weigh 5 gm of sample on an analytical balance, and transfer to a 500 ml volumetric flask. Add about 250 ml of distilled water, and mix with a swirling motion. If the sample does not completely dissolve, stopper the flask and let set overnight. Bring the sample up to volume with distilled water, and mix well. Pipette a 10 ml aliquot, and transfer to a 250 ml erlenmeyer flask. Add 5 ml of a 2% dextrin solution and 10 drops of 0.1% dichlorofluorscein indicator. Titrate in

subdued light with 0.1N silver nitrate to the color change from greenish-yellow in the solution to a salmon pink on the suspended precipitate.

3.2.2. Calculations: $\text{mL} \times 5.8434 = \text{Percent NaCl}$

3.3. Moisture Content Determination:

3.3.1. On a top load balance, weigh a 150 ml beaker. Half-fill the weighed beaker with salt, and weigh again. Heat beaker with the salt in an oven at a temperature of 105°C to 110°C, for three hours. Cool in desiccator and reweigh.

3.3.2. Calculations:

$\text{Wt. beaker and salt} - \text{Wt. beaker} = \text{Wt. Sample}$

$\text{Wt. beaker and salt from oven} - \text{Wt. beaker} = \text{Wt. salt}$

$\text{Wt. sample} - \text{Wt. salt} = \text{Wt. moisture}$

$\text{Wt. moisture divided by Wt. sample} \times 100 = \% \text{ Moisture}$

4. CALCULATIONS: Calculations are included in the Procedure.

5. PRECAUTIONS: A few drops of nitric acid may be used to aid in dissolving the salt sample. If nitric acid is used the solution must be adjusted to a pH of approximately 7 with calcium chloride.

6. REPORT:

6.1. Percent passing each required sieve.

6.2. % Sodium Chloride

6.3. % Moisture

APPROVED

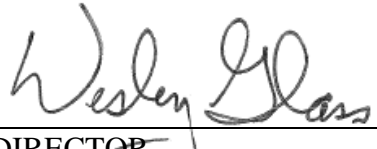

DIRECTOR
DIVISION OF MATERIALS

DATE

04/15/08

Kentucky Method 64-225-08
Revised 04/15/08
Supersedes KM 64-225-02
Dated 12/27/02

WATER FOR USE WITH CEMENT

1. SCOPE: This test method outlines the procedure for sampling and testing water for use with cement.
2. APPARATUS AND MATERIALS:
 - 2.1. 0.1 Normal Sulfuric Acid
 - 2.2. 0.02 Normal Sodium Hydroxide
 - 2.3. Methyl Orange Indicator
 - 2.4. Phenolphthalein Indicator
 - 2.5. Potassium Chromate Indicator
 - 2.6. 0.1 AgNO₃
 - 2.7. pH Meter: Calibrated at pH 4.0, pH 7.0, and pH 10.0
3. SAMPLE: Water samples are received in a 0.95 liter (quart) glass or plastic containers.
4. PROCEDURE:
 - 4.1. Organic and Inorganic Solids: - (Run in Duplicates)
 - 4.1.1. Heat a 50 ml porcelain crucible in a muffle furnace at 950 °C for 15 minutes. Cool in desiccator, and carefully weigh to 0.0001 grams. Shake sample well, and measure 25 ml in graduated cylinder. Immediately transfer to weighed crucible. Place crucible on steam bath, or on asbestos pad on hot plate, and evaporate to dryness. Place in oven at temperature of 110 °C for one hour. Cool in desiccator and re-weigh.

Gain in Weight x 4 = Total Solids
 - 4.1.2. Heat crucible and total solids in muffle furnace at 950 °C for 30 minutes. Cool in desiccator and re-weigh.

Loss in weight x 4 = Organic Solids
 - 4.1.3. Inorganic solids are determined by subtracting organic solids from total solids. Organic solids and inorganic solids are reported separately.

4.2. Acidity or Alkalinity:

4.2.1. Most water samples received are alkaline. Test results are reported as percent total alkalinity in terms of calcium carbonate.

4.2.2. Measure 100 ml of sample in a graduated cylinder after shaking well. Transfer to porcelain casserole, and add 3 drops of methyl orange indicator. Titrate to orange end point by adding 0.1N sulfuric acid drop by drop from a burette.

$$\text{ml } 1/10 \text{ N H}_2\text{SO}_4 \times .005005 = \text{Percent Alkalinity as CaCO}_3$$

4.2.3. If acidity is to be determined, the same general procedure as above may be used by titrating with 0.02 N sodium hydroxide solution using phenolphthalein as the indicator.

4.3. Chloride ion in water: Procedure in ASTM D 512 Method B Silver Nitrate.

4.4. pH of water

4.4.1. Place 100 ml of sample in 150 ml beaker.

4.4.2. Add small stir bar.

4.4.3. Place on stir plate and adjust stirrer to medium speed.

4.4.4. Rinse pH probe with D.I. water and place in beaker containing sample.

4.4.5. Allow reading to stabilize, record pH and temperature in °C.

5. CALCULATIONS: Calculations are given in the Procedures.

6. PRECAUTIONS: Any precautions necessary are found in the Procedures.

7. REPORT:

- 7.1. % Total Solids
- 7.2. % Organic Solids
- 7.3. % Inorganic Solids
- 7.4. % Alkalinity or Acidity as CaCO_3
- 7.5. % Chloride ion in water
- 7.6. pH and temperature

APPROVED

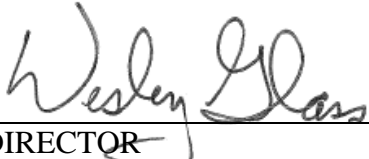

DIRECTOR
DIVISION OF MATERIALS

DATE

03/07/08

Kentucky Method 64-226-08
Revised 03/07/08
Supersedes KM 64-226-02
Dated 12/27/02

WATER-BORNE PRESERVATIVES

1. SCOPE: This test method covers water-borne timber preservatives used to treat wood that will be used in highway construction and maintenance. The chemical testing of water-borne timber preservatives is a modification of AWWA Method A2-71. Two methods are detailed in this method, "Wet Chemical Analysis" and "X-Ray Fluorescence" (preferred method).
2. SAMPLING: Preservatives shall be sampled and tested by the inspection company at the sources. When sampled by the Cabinet, a one-liter (quart) sample per lot will be taken and submitted to the Division of Materials. The test report for shipment of treated timber will show the laboratory approval number for the preservatives.
3. ALTERNATIVE WET CHEMICAL ANALYSIS AS STATED IN AWWA METHOD A2-71:
 - 3.1. Apparatus/Materials:
 - 3.1. Hydrogen Peroxide (30%)
 - 3.2. Sulfuric Acid, Conc.
 - 3.3. Perchloric Acid, 70%.
 - 3.4. Nitric Acid, Conc.
 - 3.5. Hydrochloric Acid, Conc.
 - 3.6. Hypophosphorous Acid, 50%.
 - 3.7. Potassium Bromate, 0.050N: dissolve 1.392 grams of pure dry potassium bromate in distilled water, and make up to 1.0 liter in a volumetric flask. For 0.100N, use 2.784 grams.
 - 3.8. Methyl Orange: 0.1 percent water solution.
 - 3.9. Ammonium Hydroxide, conc.
 - 3.10. Alcohol, Methyl.
 - 3.11. Potassium Iodine Solution, 20 percent: dissolve 20 grams KI in 80 ml of water.
 - 3.12. Sodium Thiocyanate Solution, 20 percent: dissolve 20 grams NACNS in 80 ml of water.

- 3.13. Starch Indicator Solution: Make a paste of 1 gram soluble starch in about 5 ml water. Add 100 ml water, and boil, with stirring, until solution is clear. Cool, and add 1 drop of chloroform. This solution is subject to decomposition, and fresh solution should be made if a dark blue color is not produced when a drop is added to an iodide solution.
- 3.14. Acetic Acid, Glacial.
- 3.15. Copper foil, or shot: to be used for standardization of sodium thiosulfate solution.
- 3.16. Urea Solution - 5 percent: to be used in standardization of sodium thiosulfate solution. Dissolve 5 grams of urea in 95 ml water.
- 3.17. Sodium Thiosulfate Solution, 0.1N: purchase standard solution. For method of checking, see AWWA Methods.
- 3.18. Sodium Thiosulfate Solution, 0.01N: dilute 50 ml of standard 0.1N sodium thiosulfate solution to 500 ml in volumetric flask using freshly boiled distilled water which has been cooled to room temperature. This solution should be made up immediately before use.
- 3.19. Phosphoric Acid, 85% (Sp. Gr.- 1.71).
- 3.20. Barium Diphenylamine Sulfonate Solution: 0.20 g made up to 100 ml with water.
- 3.21. Ferrous Ammonium Sulfate - Sulfuric Acid Solution: 140 grams of ferrous ammonium sulfate, $\text{Fe}(\text{NH}_4)_2 \cdot 6\text{H}_2\text{O}$ and 25 ml of concentrated sulfuric acid made up to one liter with water.***
- 3.22. Sulfuric Acid, 1:1 solution: add one volume of concentrated sulfuric acid slowly and with constant stirring to one volume of water. Cool before use.
- 3.23. Potassium Dichromate Solution, 0.2000N: weigh 9.807 grams of dry potassium dichromate into a 1 liter volumetric. Dissolve thoroughly, and dilute to 1 liter with water at room temperature. For 0.1000N, use 4.9035 grams of dry potassium dichromate.

3.2. Preparation:

3.2.1. Wet ashing of borings.

- 3.2.1.1. Add slowly two volumes of hydrogen peroxide (30%) to one volume of concentrated sulfuric acid. Mix well and cool.
- 3.2.1.2. Measuring from outside surface cut borings into 15 mm (0.6 inch) specimens. Count and divide into 2 or 3, 500 ml Phillips Beakers, depending on apparent concentration. To each beaker add 30 ml cooled mixture and let soak for 5 minutes. Warm slowly on hot

plate. Increase heat, and digest until solution chars. Remove from hot plate. Add 10 ml perchloric acid. Wash down sides of flask with nitric acid, and return to hot plate. Solution will boil and become still. It boils again and changes color. Red or dark orange for CCA; light green for ACA. Remove from heat and cool. Combine into a 100 ml flask, rinsing each beaker well. Dilute to 100 ml, and mix well. Use 25 ml aliquot for each determination.

3.2.2. Liquid Preservatives: These samples should be mixed thoroughly. Samples may be obtained by filling a disposable syringe with the well mixed solution. The samples are then squirted into the appropriate receptacles, and weight by difference is recorded. 1 gram samples are usually taken, but 0.5 grams is better for CuO. 1 gram is equal to approximately 1 ml of solution.

3.3. Procedure:

3.3.1. By referring to AWWA Std. P5-72, it can be determined which tests should be run.

3.3.2. Arsenic (As_2O_5):

3.3.2.1. Place sample in 500 ml Phillips Beaker and add water to make a volume of about 50 ml. Add 50 ml of HCl and 20 ml of hypophosphorous acid. Mix thoroughly, and warm on steam bath until precipitate is formed. Boil about 15 minutes until the precipitate separates out. Filter the hot solution through a 10 ml Gooch crucible containing a glass fiber pad, washing flask and precipitate thoroughly with water. Place the Gooch back into the Phillips beaker and discard the filtrate. To this beaker, add 15 ml of sulfuric acid and heat over an open flame, while agitating, until copious fumes are evolved and all the arsenic has been converted. Cool and gradually add 100 ml of water. Add 7 ml HCl and 5 drops of methyl orange, and immediately titrate with standard potassium bromate solution to a colorless end-point.

3.3.2.2. Calculations:

Borings:

$$\frac{mL \times N \times \text{Dilution Factor} \times 0.218894 \times 16.01846}{\text{Volume}}$$

$$= \text{kg/m}^3 (16.01846 \times \text{lbs/ft}^3) As_2O_5$$

Liquid:

$$\frac{\text{mL} \times \text{N} \times 5.746}{\text{Weight}} = \% \text{As}_2\text{O}_5$$

3.3.3. Copper (CuO):

3.3.3.1. Place samples in 300 ml Erlenmeyer flask, and add 50 ml H₂O. Add 10 ml HCl and a few glass beads. Add 20 ml methyl alcohol carefully, warm to boiling and heat until all chromium is gone. The solution should be clear bluish green and show no signs of presence of methyl alcohol. Wash down the sides of the flask with water, boil for 1 minute and cool. Add NH₄OH cautiously until a permanent precipitate just forms. Add H₂SO₄ drop by drop until the precipitate just dissolves. Dilute to 125 ml and cool. Add 10 ml 20 percent potassium iodide solution and 5 ml 20 percent sodium thiocyanate solution and mix thoroughly by rotating the flask. Add 2 ml starch solution and titrate with 0.01N sodium thiosulfate solution. With ACA, the end-point change is from dark blue to cream color. In CCA, it is from dark blue to light green.

3.3.3.2. Calculations:

Borings - (Using 0.01N sodium thiosulfate)

$$\frac{\text{mL} \times \text{N} \times \text{Dilution Factor} \times 0.218894 \times 16.01846}{\text{Volume}}$$
$$= \text{kg/m}^3(16.01846 \times \text{lbs/ft}^3) \text{CuO}$$

Liquid

$$\frac{\text{mL} \times \text{N} \times 7.96}{\text{weight}} = \% \text{CuO}$$

3.3.4. Chromium (CrO₃):

3.3.4.1. Place the sample in a 500 ml Erlenmeyer flask with sufficient water to make a total volume of about 100 ml. A blank must also be run. Add 5 ml of phosphoric acid and 7 ml of 1:1 sulfuric acid and stir the solution well. Immediately pipet exactly 10 ml of ferrous ammonium sulfate solution into the solution and add 8 drops of barium diphenylamine sulfonate solution. Immediately titrate the solution with standard 0.1N potassium dichromate solution. **The endpoint has been reached when the color of the solution becomes deep purple or deep greenish.

3.3.4.2. Calculations:

Borings (Using 0.1N Potassium Dichromate)

$$\frac{\text{Differences in ml} \times \text{Dilution Factor} \times 0.0127 \times 16.01846}{\text{Volume}}$$

$$= \text{kg/meter}^3 \text{CrO}_3 \text{ (16.01846} \times \text{lbs/ft}^3\text{)}$$

Liquids

$$\frac{\text{Difference in ml} \times \text{Factor}}{\text{Sample Weight}} = \text{CrO}_3$$

Factors

Using 0.2N - 0.6668

Using 0.1N - 0.3334

3.4. Calculations:

3.4.1. For each active ingredient, see calculations under Procedure.

3.4.2. Volume of borings = 0.01884 x no. of borings.

3.5. Precautions:

3.5.1. Special care must be taken with any solution containing perchloric acid, especially when combined with a strong reducing agent, such as hypophosphorous acid. It must not be evaporated too much and should be covered with a small water-glass during this procedure.

3.5.2. In the determination of arsenic the solution must be kept hot until after it is treated with sulfuric acid.

3.6. Report:

3.6.1. Borings:

3.6.1.1. Kg/m³ (lbs/ft³ multiplied by 16.01846) of each active ingredient.

3.6.1.2. Kg/m³ (lbs/ft³ multiplied by 16.01846) total active ingredient.

3.6.2. Liquid:

- 3.6.2.1. Percent concentration of each active ingredient.
- 3.6.2.2. Total percent concentration active ingredients (salts).
- 3.6.2.3. Percent of total salts - each salts.

*NOTE 1: In used solutions, the accumulation of organic materials may cause inconsistent copper titrations. If this occurs, see NOTE on page 6 of AWWA Method A2 - 71.

**NOTE 2: 0.2N potassium dichromate may be used, but the end point is much more difficult to discern.

***NOTE 3: Since ferrous ammonium sulfate solutions change strength rapidly, solution should be standardized or blanks run for each determination.

4. X-RAY FLUORESCENCE (Preferred Method):

4.1. Apparatus/Materials:

- 4.1.1. Philips MagiX PRO Wavelength Dispersive x-ray fluorescence spectrometer.
- 4.1.2. SuperQ software
- 4.1.3. Carver hydraulic press
- 4.1.4. Tungsten Carbide 31mm die set
- 4.1.5. Spex 8000 mixer/mill

4.2. Procedure – X-Ray Fluorescence:

- 4.2.1. Dry wood sample in oven at 110°C for at least 2 hours.
- 4.2.2. Weigh approximately 6 grams of sample and place into the Spex 8000 mixer/mill and grind until a powder is obtained and/or sample is completely uniform. This may take several minutes.
- 4.2.3. Place homogenous sample in the die. Press to 33,000lbs and allow pressure to release very slowly.
- 4.2.4. Enter names of samples in the measure sample screen on the measure and analyze program.
- 4.2.5. Place sample in 27mm steel cup. Then place in x-ray instrument and prepare to run wood application on the measure sample screen. Click on measure at the bottom of the screen. This may take a few minutes. The application chosen is dependent upon the sample type.

4.3. Quantification: Program quantifies data by using a least squares program. Similar samples with known chemical compositions are used as standards in the quantification technique. As many standards as possible are used for best quantification. The results are reported as oxides in weight percents.

4.4. Report:

4.4.1. % As_2O_5

4.4.2. % CuO

4.4.3. % CrO_3

APPROVED

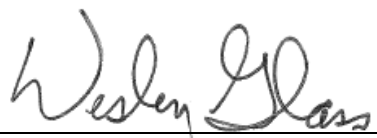

DIRECTOR
DIVISION OF MATERIALS

DATE

04/15/08

Kentucky Method 64-227-08
Revised 04/15/08
Supersedes KM 64-227-03
Dated 02/19/03

FERTILIZER

1. SCOPE: This method covers fertilizers used in preparing seed beds and shall be carriers of available plant food elements or combinations thereof, either as organic or inorganic materials. The fertilizer shall be standard commercial fertilizer supplied separately or in mixtures containing the percentages of total nitrogen, available phosphoric acid, and water-solubles potash specified in the contract. The fertilizer and labels shall conform to all existing state and federal regulations. Any fertilizer which becomes caked, or otherwise damaged as to make it unsuitable for use, will not be accepted.
2. APPARATUS AND MATERIALS:
 - 2.1. 300 μm (No. 50) sieve
 - 2.2. 500 ml Kjeldahl Flasks
 - 2.3. Tri-N Butyl Citrate
 - 2.4. Hydrochloric Acid
 - 2.5. Digestion Mixture containing 10 g K_2SO_4 , 0.2 g Se, 0.6 g HgO, 0.5 g CuSO_4 and 1.5 g Alundum.
 - 2.6. Sulfuric Acid
 - 2.7. Sodium Thiosulfate (160 g $\text{Na}_2\text{S}_2\text{O}_3 \cdot 5\text{H}_2\text{O}$ /liter)
 - 2.8. 50% Sodium Hydroxide
 - 2.9. 0.5 NH_2SO_4
 - 2.10. Boric Acid (saturated solution)
 - 2.11. Apparatus and Materials that appear in AOAC methods 2.023 and 2.083.
 - 2.12. N-Point Indicator
 - 2.13. Mossy Zinc
3. SAMPLE:
 - 3.1. One 0.95 liter (quart) sample per type per source will be submitted to the Division of Materials, and results obtained before permitting use. If possible, a tube sampler shall be

used to obtain samples. If quantity is less than 10 bags, each bag will be sampled and combined to form a 0.95 liter (quart) sample. If more than 10 bags, select 10 bags and sample, combining to make a 0.95 liter (quart) sample.

- 3.2. Fertilizer may be accepted on the basis of written certifications by the vendor and by the contractor, or on the basis of sampling and testing by the Cabinet. If certifications are used, they shall be prepared and presented in triplicate to the engineer at the time of delivery of the fertilizer. In the event the engineer has reason to believe that the fertilizer has become contaminated, or is otherwise questionable, it shall be sampled and tested prior to use.

4. PROCEDURE:

- 4.1. Preparation: The sample should be reduced to about 100 grams by use of a sand splitter. This portion is ground in an iron mortar and pestle until the entire sample passes a 300 μm (No. 50) sieve. Care should be taken to prevent any change in moisture content during grinding and sieving. The sample is stored in a sample jar with a tight fitting cap.

4.2. Nitrogen:

- 4.2.1. Weigh, by difference, a sample containing not more than 60 mg of nitrogen as nitrate, and transfer to a 500 ml Kjeldahl flask. Add 1.2 g of chromium powder and 35 ml of distilled water. Allow the mixture to stand for 10 minutes with occasional swirling to insure solution of all nitrate in the sample. Add 7 ml of concentrated HCl and 2 - 3 drops of Tri-N-Butyl Citrate. Let the mixture stand until visible action occurs. This requires 1 - 5 minutes. Place the flask over a Bunsen burner that has been pre-set to give a 5-minute boil. The maximum heating time is 5 minutes. Remove flask from heat, and allow to cool.
- 4.2.2. Add 12.8 g of digestion mixture which contains the following: 10 g of K_2SO_4 , 0.2 g Se, 0.5 g HgO, 0.5 g CuSO_4 and 1.5 g alundum. Add 25 ml of concentrated H_2SO_4 . Place the flask over a pre-tested burner regulated to give a 5-minute boil time. Allow 15-20 minutes for the copious white fumes to clear out of the bulb of the flask. Swirl gently. Digest for an additional 30 minutes.
- 4.2.3. Allow the flask and contents to cool to room temperature. Place a 400 - 500 ml beaker containing 100 ml of saturated boric acid solution under discharge tube of condenser (standard Kjeldahl distillation apparatus). Dilute sample to 300 ml with distilled water, and add 25 ml of sodium thiosulfate solution (160 g $\text{Na}_2\text{S}_2\text{O}_3 \cdot 5\text{H}_2\text{O}$ per liter). Add a few pieces of zinc to prevent bumping. Add 100 ml 50% NaOH. Add NaOH slowly while holding neck of flask at about 45° angle. Attach flask, with gentle swirling movement, to condenser of the distillation apparatus. Heat gently at first. After boiling begins increase the heat. Distill over at least 150 ml. Use 7 - 9 drops of N-end point indicator in the boric acid receiving solution. Titrate NH_3 with standard H_2SO_4 0.5 N solution.

4.2.4. A blank determination should be made to correct for the trace amount of N₂ present in chromium powder.

4.2.5. Calculations:

$$\frac{[mL H_2SO_4(Sample) - mL H_2SO_4(Blank)] \times N \times 1.4008}{Weight\ of\ Sample} = \% Nitrogen$$

4.3. Phosphate: AOAC 2.024

4.4. Potash: AOAC 2.083

5. CALCULATIONS: Calculations are covered in the Procedures.

6. PRECAUTIONS: Precautions are covered in the Procedures.

7. REPORT:

7.1. % Nitrogen

7.2. % Available Phosphoric Acid

7.3. % Potash

APPROVED

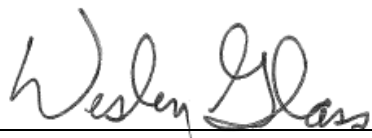

DIRECTOR
DIVISION OF MATERIALS

DATE

04/15/08

Kentucky Method 64-241-08

Revised 04/15/08

Supersedes KM 64-421-02

Dated 12/27/03

HERBICIDES

1. SCOPE: The following test methods cover material for control of weeds, brush and other noxious vegetation on highway right of way. Herbicides shall meet specifications indicated on plans, proposals or bidding invitations.
2. APPARATUS AND MATERIALS:
 - 2.1. 500 ml Separatory Funnel
 - 2.2. Ethyl Ether
 - 2.3. Electric Fan
 - 2.4. Formula 3A Alcohol
 - 2.5. Phenolphthalein Indicator
 - 2.6. 0.1N Sodium Hydroxide
 - 2.7. Stirring Bar and Magnetic Stirrer
 - 2.8. Centrifuge
 - 2.9. pH Meter
 - 2.10. Hydrometer
3. SAMPLE: A 0.95 liter (quart) sample of each type per source shall be submitted to the Division of Materials. Samples shall be taken with care using clean equipment and clean containers.
4. PROCEDURES FOR 2,4,-D (ALKANOLAMINE SALT OF 2,4-D):
 - 4.1. Total 2,4-D Acid:
 - 4.1.1. Weigh by difference from a stoppered vial 1.5 to 2 g sample. Add sample to 150 ml beaker. Add 50 ml of distilled water. Transfer to 500 ml pear-shaped separatory funnel. Rinse beaker with water, and add to funnel. Add 10 ml of H₂SO₄ (10%) to funnel, and swirl to mix thoroughly. Extract with 75 ml of ether. Shake vigorously. Invert funnel and open stopcock to relieve pressure. Set funnel in ring holder until layers separate. Draw off bottom layer into another separatory funnel. Save ether layer in first funnel. To water layer in second funnel add 75 ml of ether, and extract as before. Draw off bottom layer, and discard. Combine two ether layers. Rinse empty funnel with ether and add to other funnel. Add 10 ml of

distilled water and shake vigorously. Draw off bottom layer and discard. Repeat this procedure two more times. Place a plug of cotton in a filter funnel, and saturate with ether. Filter sample through the funnel into a clean 400 ml beaker. Rinse separatory funnel with ether and filter through same cotton. To the filtrate add 25 ml of distilled water and a few glass beads. Evaporate at a very low heat until about 25 ml of ether remains above the water layer. Remove from hot plate, and complete the evaporation of the ether layer by placing sample in front of a medium speed electric fan. When ether layer is completely evaporated, add 100 ml of Formula 3A ethyl alcohol, and stir until the 2,4-D has dissolved. Add 5 - 7 drops of phenolphthalein indicator, and titrate with 0.1N NaOH carefully until 1 drop of NaOH gives a pink end point.

4.1.2. Calculations:

$$\frac{mL\ NaOH \times 2.21 \times N\ \frac{NaOH}{0.1}}{Wt.\ of\ Sample} = \% \ 2,4 - D\ Acid$$

- 4.2. Foam Test: Add 5 ml of sample to 100 ml of tap water in a 250 Erlenmeyer flask, stopper, and shake vigorously. At the instant the shaking is stopped, start a stop watch. Stop the watch the moment the foam breaks. This usually requires 4 - 5 seconds.
- 4.3. Dilution Test: Use the solution prepared for the foam test. Add teflon covered stirring bar, and stir for two hours on magnetic stirrer. The solution should be clear after 2 hours.
- 4.4. 2, 4-D Acid Equivalent in Grams Per Liter (Pounds Per Gallon multiplied by 119.8264):
- 4.4.1. Determine specific gravity of sample at 25°C (77°F) by using a hydrometer.
- 4.4.2. Calculations: % 2, 4-D x Sp. Gr. x 8.33 x 119.8264 = grams/liter
- 4.5. Sediment: Fill a Goetz centrifuge tube to the 100 ml mark with the sample. Counter balance with another tube and water. Centrifuge at 1500 RPM for about 30 minutes. The first graduation on the stem of the centrifuge tube is 0.01 ml. If the sediment is below this mark, report sediment as less than 0.01 percent.
- 4.6. pH Determination: Determine pH of sample at 25°C (77°F) using a regular laboratory pH meter, and using standard procedure for operating the meter.

5. CALCULATIONS FOR 2,4-D: Calculations are included in the Procedures.

6. PRECAUTIONS FOR 2,4-D: The usual precautions, such as avoiding open flames, must be taken when using ether.

7. REPORT FOR 2,4-D:

7.1. % 2,4-D

7.2. Results of Foam Test in Seconds

7.3. Results of Dilution Test

7.4. 2,4-D Acid Equivalent in Grams per Liter (Pounds per Gallon multiplied by 119.8264)

7.5. % Sediment

APPROVED

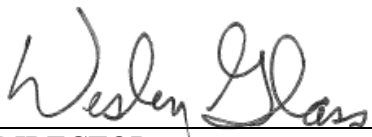

DIRECTOR
DIVISION OF MATERIALS

DATE

04/15/08

Kentucky Method 64-242-08
Revised 04/15/08
Supersedes KM 64-242-03
Dated 01/17/03

SAMPLING AND TESTING SOILS (CHEMICAL)

1. SCOPE: This test method is intended for soil that is to be used in preparation of seed beds for various plant growth needed in erosion control, landscaping and other uses.
2. APPARATUS AND MATERIALS: Apparatus and materials required are given in the Procedure.
3. SAMPLE: When set forth in Project Specifications, one (1) 2.3 kg (five pounds) sample per type of soil (as defined by Soil Science Society of America) shall be submitted to the Division of Materials for Chemical Analysis and Texture Classification (U. S. Department of Agriculture Textural Classification Chart). Approval or disapproval will be made by the Agronomy Section of the Division of Construction.
4. PROCEDURE:
 - 4.1. Sample Preparation:
 - 4.1.1. Sample should be air dry.
 - 4.1.2. Soil should be crushed with a mortar and pestle. Avoid crushing any rock or organic matter.
 - 4.1.3. Pass the soil through a No. 10 sieve.
 - 4.1.4. Mix the sieved soil thoroughly.
 - 4.1.5. Save a small jar (120 ml, or 4 ounces) of soil for the testing sample.
 - 4.2. Determination of Soil pH:
 - 4.2.1. Apparatus and Materials:
 - 4.2.1.1. pH Meter
 - 4.2.1.2. Buffer solution
 - 4.2.1.3. 150 ml beaker
 - 4.2.1.4. Distilled water
 - 4.2.2. Ph: Calibrate the glass electrode of the pH meter carefully with a buffer solution. Weigh 5 grams of the soil sample (analytical balance) and place in a 150 ml beaker. Add 10 ml of distilled water from a graduated cylinder. Swirl the sample and water

for 30 seconds, and allow to stand for 30 minutes. Swirl again, insert the electrodes, and read the meter. Record the reading. **SAVE THE SAMPLE.**

4.3. Determination of Exchangeable Hydrogen:

4.3.1. Apparatus and Materials:

4.3.1.1. The same equipment and reagents used in soil pH determinations (4.2.1.1 - 4) are also used in this determination.

4.3.1.2. In addition to the above, a nitrophenol buffer is used. 8 g paranitrophenol, 40 g Ca (CH₃COO) 2.H₂O and 0.625 g MgO per liter of distilled water. This solution is adjusted to pH 7.0 by either HCl or MgO as required.

4.3.2. Exchangeable Hydrogen: Calibrate the pH meter with the prepared nitrophenol buffer to a pH of 7.0. Add 10 ml of the nitrophenol mixture with a pipette to the soil sample that was used in the pH determination. Swirl for 30 seconds, and allow to stand for 30 minutes. Swirl again, and read the meter. Each change of one tenth in pH on going from pH of 7.0 to pH of 6.0 is equivalent to 1 M.E. of hydrogen per 100 grams of soil. Do not try to run exchangeable hydrogen on an alkaline soil.

4.4. Determination of Phosphorous:

4.4.1. Apparatus and Materials:

4.4.1.1. High phosphate slide

4.4.1.2. Whatman No. 1 Filter Paper, 11 cm

4.4.1.3. 50 ml beaker

4.4.1.4. 50 ml Erlenmeyer Flask

4.4.1.5. 20 ml pipette

4.4.1.6. No. 1, or No. 2 Rubber Stopper

4.4.1.7. 0.5 ml rubber bulb pipette and vial

4.4.1.8. 5 ml comparator tube

4.4.1.9. Graduate pipette

4.4.1.10. Distilled water

- 4.4.1.11. Concentrated stannous chloride (preparation given at the end of procedure)
- 4.4.1.12. Molybdate solution (preparation given at the end of procedure)
- 4.4.1.13. 0.15 N H₂SO₄ Extraction solution

4.4.2. Phosphorus:

- 4.4.2.1. Put 5 g of soil sample into a 50 ml Erlenmeyer flask. Add 20 ml of extracting solution (0.15 N H₂SO₄) with a pipette. stopper, and shake for 2 minutes. Let it set for 15 seconds and then pour into a funnel containing Whatman No. 1 filter paper. The filtrate is collected in a 50 ml beaker. To another 50 ml beaker, add by pipette 10 ml of molybdate solution. To the 10 ml of molybdate, add 5 ml of the soil filtrate. Add 2.5 ml of diluted stannous chloride to the solution. Swirl the beaker and pour 5 ml into a comparator tube. Allow three minutes to elapse, and then make a reading on the High Phosphorus Slide. Available phosphorus is determined by multiplying the results of the color comparison (High Phosphate Slide) by 3. This will give you lbs. per acre.
- 4.4.2.2. Molybdate Solution for Phosphorus (1 liter): Weigh 9.0 grams (8.98 - 9.06) of ammonium molybdate (reagent grade), and add to 250 ml distilled water in a 600 ml beaker. It will help to heat the water, but do not exceed 50°C. Add 175 ml of exactly 10 N H₂SO₄, transfer to a 1000 ml volumetric flask, and cool to at least 30°C before adjusting to final volume with distilled water. Mix thoroughly. Store in an amber bottle, or in the dark when not in use.
- 4.4.2.3. Stannous Chloride - Concentrated Solution: Dissolve 4 grams SnCl₂·2H₂O in 25 ml concentrated HCl. Keep tightly stoppered (capped) in a small vial.
- 4.4.2.4. Dilute Stannous Chloride: Measure 0.5 ml of concentrated stannous chloride with a 0.5 ml rubber bulb pipette, and dilute to 20 ml with distilled water.

4.5. Determination of Potassium:

4.5.1. Apparatus and Materials

- 4.5.1.1. Potash Test Chart
- 4.5.1.2. 50 ml Erlenmeyer Flask
- 4.5.1.3. No. 1 Whatman filter paper, 9 cm

KM 64-243-08

- 4.5.1.4. Funnel
- 4.5.1.5. Funnel vial marked at 5 ml
- 4.5.1.6. 10 ml pipette
- 4.5.1.7. Graduated pipette
- 4.5.1.8. No. 1 or No. 2 rubber stopper
- 4.5.1.9. Potash Reagent "A" (preparation given at end of procedure)
- 4.5.1.10. Potash Reagent "B" (preparation given at end of procedure)
- 4.5.2. Potassium:
 - 4.5.2.1. Place a 5 grams of soil sample into a 50 ml Erlenmeyer flask. Fold a filter paper (Whatman No. 1) and place in funnel. Add 10 ml of potash reagent "A" to the sample by pipette. Stopper and shake for 1 minute. Let the sample plus solution set for 30 seconds. Pour into the prepared filter. Obtain 5 ml of filtrate in the funnel vial. Add 2.5 ml of potash reagent "B" with a graduated pipette to the solution in the funnel vial. Shake the vial for 4 - 5 seconds. Record the exact 3-minute time interval, and then compare with the Potash Test Chart. Compare the visibility of the three black lines rather than the shades of yellow in the turbid mixture. The chart is read in pounds per acre.
 - 4.5.2.2. Preparation of Potash Reagent "A": Dissolve 5 grams of sodium cobaltinitrite, and 30 grams sodium nitrate, A. C. S. grade (Mallinckrodt's 7824 is good) in 70 ml distilled water in a 250 ml beaker, add 4 - 7 ml glacial acetic acid (A.C.S.), stir occasionally until solution turns dark (and reagents are apparently dissolved) and transfer all to a 100 ml volumetric flask with the aid of a small funnel and wash bottle. Make to 100 ml volume, mix somewhat by rolling the flask (do not invert) and let stand for 3 days with a small beaker inverted over the opening of the flask. Add the cobaltinitrite mixture to a container which will hold at least 2500 ml. Weigh out 300 grams of the sodium nitrate and by rinsing out the 100 ml volumetric flask and adding other distilled water, measure out a total of 2000 ml of distilled water with which to dissolve the sodium nitrate and add the nitrate and water mixture to the 2500 ml container. After thorough mixing the pH should be checked and adjusted with a pH meter. Preferably, it should be pH 5.0 + 0.05 but 5.0 ± 0.1 is acceptable. Keep this solution in good quality glass, or plastic, preferably in the dark with a minimum of air exposure.
 - 4.5.2.3. Potash Reagent "B": This is isopropyl alcohol A. C. S. grade (Spec. KM 64-243-08

Gravity at 25°C = 7832).

4.6. Determination of Calcium Magnesium:

4.6.1. Use the same procedure that is used for a complete limestone analysis. However, use a one gram sample in the soil analysis. Also, the conversion factors are different. They are given below.

4.6.2. Calculations:

4.6.2.1. pounds per acre of Calcium = Wt. of CaO x .71469 x 2,000,000

4.6.2.2. pounds per acre of Magnesium = Wt. of $Mg_2P_2O_7$ x .21847 x 2,000,000

4.7. Determination of Organic Matter:

4.7.1. Apparatus and Materials:

4.7.1.1. 425 μ m (# 40) Sieve

4.7.1.2. 1 N Potassium dichromate

4.7.1.3. Concentrated sulfuric acid

4.7.1.4. Orthophenanthroline ferrous complex indicator

4.7.1.5. 0.35N Ferrous ammonium sulfate

4.7.1.6. Mortar and pestle

4.7.2. Percent Carbon:

4.7.2.1. This procedure consists of treating a soil with an oxident, and determining the oxident which was not consumed in oxidizing the soil. The procedure is the Walkley-Black, or Heat of Dilution variation of the Chromic Acid Oxidation Method.

4.7.2.2. The soil should be fine enough to pass a 425 μ m (40) mesh sieve (.420 mm). A mortar and pestle may be used to pulverize a sample.

4.7.2.3. Weigh to the nearest 0.01 gram, 1 - 3 grams of soil. Use approximately 1 gram of soils high in organic material and approximately 3 grams of soils low in organic material. Place the soil in a 250 - 500 ml Erlenmeyer flask. Add 15 ml of potassium dichromate from a burette, quickly followed by adding 30 ml of concentrated H_2SO_4 . Immediately swirl vigorously for 1 minute.

Place on an asbestos sheet, or wire gauze, and let stand for 20 minutes. Slowly add 100 ml of distilled water, and swirl gently to mix. The solution will be warm. Cool the outside of the flask under a cold water tap until approximately room temperature is reached. Add 5 drops of orthophenanthroline ferrous complex indicator. Titrate the excess chromate with 0.35 N (actual normality may be different) ferrous ammonium sulfate. As the titrate proceeds, the solution will turn green, then bluish-green just before the end point, and a murky red at the end point. Record all burette readings so the proper data for calculations are available.

- 4.7.2.4. Fifteen ml of potassium dichromate should be carried through the entire procedure described except that no soil shall be included. This is known as "blank" titration.
- 4.7.2.5. Calculations: The amount of ferrous ammonium sulfate required to reduce the excess chromate (which remains after the organic carbon in the soil sample is oxidized) subtracted from the amount of ferrous ammonium sulfate used in the blank titration will be chemically equivalent to the amount of chromate that reacted with (or oxidized) the organic carbon in the soil. This chromate is directly equivalent to the oxidized carbon.

$$\text{Percent of Carbon} = \frac{0.003 (X-Y) (Z) \times 100}{0.74 S}$$

Where:

X = mL blank titration

Y = mL sample titration

Z = N of ferrous ammonium sulfate

S = Weight of sample

Using the value, calculate the percent of organic matter.

Percent Organic Matter = 1.724 x (Percent of Carbon)

5. CALCULATIONS: Calculations are covered in the Procedure.
6. PRECAUTIONS: Precautions are covered in the Procedure.

7. REPORT:

- 7.1. Soil Ph
- 7.2. Exchangeable Hydrogen
- 7.3. lbs./acre Phosphorus
- 7.4. lbs./acre Potassium
- 7.5. lbs./acre Calcium
- 7.6. lbs./acre Magnesium
- 7.7. % Organic Matter

APPROVED

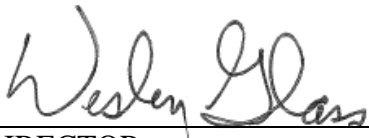

DIRECTOR
DIVISION OF MATERIALS

DATE

04/15/08

Kentucky Method 64-243-08
Revised 04/15/08
Supersedes KM 64-243-02
Dated 12/27/02

Kentucky Method 64-250-08
Revised 03/31/08
Supersedes KM 64-250-03
Dated 01/17/03

ANALYSIS FOR ISOCYANATE CONTENT

This method was discontinued March 2008. Its replacement is AASHTO TP67, "Analysis of Structural Steel Coatings for Isocyanate Content".

APPROVED

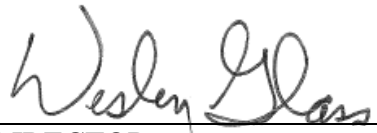

DIRECTOR
DIVISION OF MATERIALS

DATE

03/31/08

Kentucky Method 64-250-08
Revised 03/31/08
Supersedes KM 64-250-03
Dated 01/07/03

HUMIDITY CHAMBER ANALYSIS OF TRAFFIC PAINTS

1. SCOPE:
 - 1.1 This method details the use of a humidity chamber in the drying time analysis of waterborne traffic paints.
2. APPARATUS AND MATERIALS:
 - 2.1. Humidity chamber
 - 2.2. Hygrometer/Thermometer unit ([See Note 5.1](#))
 - 2.3. Cheese cloth
 - 2.4. Glass panels (4" x 10" x 1/8")
 - 2.5. Micrometer adjustable film applicator (6" path width)
 - 2.6 Eccentric wet film thickness wheel
 - 2.7. Drying time wheel and ramp
3. PROCEDURE:
 - 3.1. Prepare the humidity chamber by closing all vents and lining the bottom of the chamber with cheese cloth.
 - 3.2 Add a sufficient amount of distilled water to saturate and cover the cheese cloth.
 - 3.3 Place the hygrometer/thermometer unit in the center and against the back wall of the chamber.
 - 3.4 Close the door and allow the chamber to equilibrate.
 - 3.5 Adjust room temperature so that the temperature in the chamber is held at $73^{\circ} \pm 3^{\circ}$ F. Adjust the chamber vents so that the relative humidity in the chamber is $92 \pm 2\%$. Monitor the temperature and relative humidity conditions within the chamber throughout the duration of testing. Make appropriate adjustments to maintain acceptable conditions during each analysis.
 - 3.6. Obtain a clean, dry glass panel for each analysis. The panels should be approximately 4 inches wide by 10 inches long by and 1/8 inch thick so as to accommodate a 3 inch wide stripe of the paint to be tested. The paint should be applied with a film applicator that will

reproducibly apply a 15 ± 0.5 mil wet film.

- 3.7. Immediately after applying the paint stripe, place the panel horizontally in the preconditioned humidity chamber.
- 3.8 Evaluate the drying time of the paint in accordance with ASTM D 711-89, Standard Test Method for No-Pick-Up Time of Traffic Paint.

4. REPORT:

- 4.1 Report the elapsed time between application of the film and the point at which no paint is picked up by the wheel. This time interval should be reported to the nearest minute, not to exceed 85 minutes.

5. NOTES:

- 5.1 The hygrometer/thermometer unit should comply with or exceed the following specifications; thermometer range of 32° to 122°F with an accuracy of $\pm 1^\circ\text{F}$, hygrometer range of 25 to 95 % relative humidity with an accuracy of 2% relative humidity. The hygrometer/thermometer unit should be calibrated and certified to meet these specifications annually.
- 5.2 Do not place more than two specimens in the chamber at any given time. Failing specimens should be verified individually

APPROVED



DIRECTOR
DIVISION OF MATERIALS

DATE

03/07/08

Kentucky Method 64-251-08
Revised 03/07/08
Supersedes KM 64-251-02
Dated 12/27/02

Kentucky Method 64-253-08
Revised 03/13/08
Supersedes KM 64-253-03
Dated 01/07/03

CHEMICAL ANALYSIS OF FLY ASH AND MICROSILICA

1. SCOPE:

- 1.1. This method is a modification of ASTM C-114, as referenced in ASTM C-311, for the chemical testing of fly ash by x-ray spectroscopy.
- 1.2. This method is also used for the chemical testing of microsilica by x-ray spectroscopy.

2. APPARATUS:

- 2.1. 30ml Porcelain crucible
- 2.2. Muffle furnace: maintained at 750°C
- 2.3. Desiccator
- 2.4. Balance: capable of accurately weighing to 0.0001g
- 2.5. Drying oven: maintained at 110° C
- 2.6. Philips Perl'x 3 fused bead machine
- 2.7. Platinum dish and crucible set
- 2.8. Lithium Bromide (LiBr): 10% solution non-wetting agent
- 2.9. 67% Lithium Tetraborate (Li₂B₄O₇) : 33% Lithium Metaborate (LiBO₂) flux
- 2.10. Lithium Metaborate (LiBO₂) flux
- 2.11. 27mm Steel sample cup and insert
- 2.12. Philips MagiX PRO Wavelength Dispersive x-ray fluorescence spectrometer
- 2.13. SuperQ software

3. PROCEDURE:

- 3.1. Determine moisture content by weight percent.
 - 3.1.1. Prepare porcelain crucibles by igniting in a muffle furnace at 750°C to constant weight. Cool and store crucibles in a dessicator to avoid absorption of moisture

- 3.1.2 Weigh approximately 2 grams of sample into a prepared porcelain crucible. Record the sample weight to the nearest 0.0001g.
- 3.1.3. Dry the sample to a constant weight in an oven at 110°C.
- 3.1.4. Cool the sample to room temperature in a desiccator to avoid absorption of moisture.
- 3.1.5. Re-weigh the cooled sample. DO NOT DISCARD the sample. Record the dried sample weight to the nearest 0.0001g.
- 3.1.6. Calculate the moisture content of the sample in accordance with [Section 4.1](#).
- 3.2. Determine loss on ignition (LOI) by weight percent.
 - 3.2.1. Ignite sample retained from 3.1 to a constant weight in a muffle furnace at 750°C and cool in a dessicator.
 - 3.2.2. Re-weigh the cooled sample. DO NOT DISCARD the sample. Record the ignited sample weight to the nearest 0.0001g.
 - 3.2.3. Calculate the loss on ignition (LOI) in accordance with [Section 4.2](#).
- 3.3. Prepare and analyze fly ash sample.
 - 3.3.1. Weigh 6.0g to the nearest 0.0001g of 67% Li₂B₄O₇:33% LiBO₂ flux directly into platinum crucible.
 - 3.3.2. Weigh 0.6g to the nearest 0.0001g of fly ash sample retained from 3.2 directly into the platinum crucible.
 - 3.3.3. Add 3 drops of LiBr solution to the sample.
 - 3.3.4. Place the platinum crucible and dish in the Perl'x 3 machine and select to run program 7 ([Note 5.1](#)).
 - 3.3.5 Access SuperQ software and open the fly ash application.
 - 3.3.6 Enter the sample identification and LOI in the measure sample screen of the measure and analyze program.
 - 3.3.7 Place the prepared sample into a 27mm steel cup and load into the x-ray instrument.
 - 3.3.8 Click measure at the bottom of the measure and analyze screen ([Note 5.2](#)).
- 3.4 Prepare and analyze microsilica sample.
 - 3.4.1. Weigh 6.0g to the nearest 0.0001g of LiBO₂ flux directly into platinum crucible.

- 3.4.2. Weigh 0.6g to the nearest 0.0001g of microsilica sample retained from 3.2 directly into the platinum crucible.
- 3.4.3. Add 3 drops of LiBr solution to the sample.
- 3.4.4. Place the platinum crucible and dish in the Perl'x 3 machine and select to run program 7 (Note 5.1).
- 3.4.5 Access SuperQ software and open the fly ash application.
- 3.4.6 Enter the sample identification and LOI in the measure sample screen of the measure and analyze program.
- 3.4.7 Place the prepared sample into a 27mm steel cup and load into the x-ray instrument.
- 3.4.8 Click measure at the bottom of the measure and analyze screen (Note 5.2).

4. CALCULATION:

4.1 $MC = (A/B) \times 100$

where: A = weight of sample after drying;
B = weight of original sample.

4.2 $LOI = (A/B) \times 100$

where: A = weight of sample after ignition.
B = weight of moisture free sample.

5. NOTES:

- 5.1 Program 7 is appropriate for all classes of fly ash samples and microsilica samples. Program 7 includes: One oxidation for 4 minutes, temperature 1100°C, generator power 77, agitation angle 30, and agitation speed 15. One fusion for 5 minutes, temperature 1100°C, generator power 77, agitation angle 60, and agitation speed 20. Then a pause before casting for 10 seconds at a temperature of 1100°C. Casting time 10 seconds, temperature 1100°C, casting angle 123, casting speed 10, and time for solidification 2 minutes. Lastly there is natural air cooling for 4 minutes and forced air cooling for 2 minutes at a flow rate of 40. The setting of the dish height dial is 12/40 and is dependent on the size of the platinum dish being used.
- 5.2 Program quantifies data by using a least squares program. Similar samples with known chemical analyses are used as standards in the quantification technique. As many standards as possible are used for best quantification. The results are reported as oxides in weight percents.

6. REPORT:

6.1. Report the following values for fly ash samples.

6.1.1. % Moisture Content

6.1.2. % LOI

6.1.3. % SO₃

6.1.4. % Al₂O₃

6.1.5. % Fe₂O₃

6.1.6. % R value: for class C fly ashes only. $[(CaO - 5) / Fe_2O_3]$

6.1.7. % MgO

6.1.8. % Na₂O

6.1.9. % K₂O

6.1.10. % CaO

6.1.11. % SiO₂

6.2 Report the following values for microsilica samples.

6.2.1 % Moisture Content

6.2.2 % LOI

6.2.3 % SiO₂

APPROVED

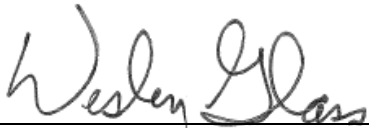

DIRECTOR
DIVISION OF MATERIALS

DATE

03/13/08

Kentucky Method 64-253-08
Revised 03/13/08
Supersedes KM 64-253-03
Dated 01/17/03

CHEMICAL ANALYSIS OF CEMENT

1. SCOPE: This method is a modification of ASTM C-114 for the chemical testing of cement by x-ray spectroscopy.
2. APPARATUS –MATERIALS:
 - 2.1. Philips MagiX PRO Wavelength Dispersive x-ray fluorescence spectrometer.
 - 2.2. SuperQ software
 - 2.3. Philips Perl'X 3 fused bead machine
 - 2.4. Platinum dish and crucible set
 - 2.5. Lithium Bromide (LiBr): 10% solution non-wetting agent
 - 2.6. 100% Lithium Tetraborate ($\text{Li}_2\text{B}_4\text{O}_7$) flux
3. PROCEDURE:
 - 3.1. Prepare porcelain crucibles by igniting at 950°C to a constant weight. Cool and store in a desiccator to avoid absorption of moisture.
 - 3.2. Weigh 1.0 gram of cement sample accurately to 0.0001 grams into a prepared porcelain crucible. Ignite sample to a constant weight in a muffle furnace at 950°C and cool in a desiccator.
 - 3.3. Calculate the loss on ignition (LOI) using the following formula:
$$\text{LOI} = (A/B) \times 100$$

where: A = weight of sample after ignition;
B = weight of original sample.
 - 3.4. Weigh accurately to 0.0001 grams 6.0 grams of flux directly into platinum crucible. Then weigh accurately to 0.0001 grams 0.6 grams of LOI free cement sample directly into the platinum crucible. Add 3 drops of LiBr solution. Place the platinum crucible and dish in the Perl'X 3 machine and select to run program 9* for all types of cement. This takes approximately 15 minutes. Program run is dependent on sample type.
 - 3.5. Open the cement application and enter the sample identification and LOI information in the measure sample screen on the measure and analyze program.

- 3.6. Place sample in a 27mm steel cup. Then place in x-ray instrument and prepare to run cement application on the measure sample screen. Click on measure at the bottom of the screen. This may take a few minutes. The application chosen is dependent upon the sample type.
4. QUANTIFICATION: Program quantifies data by using a least squares program. Similar samples with known chemical make-ups are used as standards in the quantification technique. As many standards as possible are used for best quantification. The results are reported as oxides in weight percents.
5. REPORT:
 - 5.1. % LOI
 - 5.2. % Insolubles
 - 5.3. % SO₃
 - 5.4. % Al₂O₃
 - 5.5. % Fe₂O₃
 - 5.6. % C₃A (2.650 x %Al₂O₃) – (1.692 x %Fe₂O₃)
 - 5.7. % MgO
 - 5.8. % Na₂O
 - 5.9. % K₂O
 - 5.10. % CaO
 - 5.11. % SiO₂
 - 5.12. % Total Alkali (Na₂O + 0.658 x K₂O)

* NOTE: Program 9 includes the following: One oxidation for 2 minutes, temperature 1100°C, power of generator 77, agitation angle 25, and agitation speed 10. One fusion for 6 minutes, temperature 1100°C, power of generator 77, agitation angle 50 and agitation speed 15. Then there is a pause before casting for 10 seconds at a temperature of 1100°C. Casting lasts 2 minutes, temperature 1100°C, casting angle 123, casting speed 10 and time for solidification is 30 seconds. Lastly, there is natural cooling for 1 minute and forced air cooling for 3 minutes at a flow rate of 40. The setting of the dish height dial is 40/12 and this depends on the size of the platinum dish used.

APPROVED



DIRECTOR
DIVISION OF MATERIALS

DATE

03/07/08

Kentucky Method 64-254-08
Revised 03/07/08
Supersedes KM 64-254-03
Dated 01/06/03

Kentucky Method 64-256-08
Revised 04/18/08
Supersedes KM 64-256-02
Dated 12/27/02

RESISTANCE TESTING OF STRUCTURAL STEEL COATINGS TO METHYL ETHYL KETONE

1. SCOPE:

1.1 This method outlines the use of methyl ethyl ketone (MEK) for chemical resistance evaluations of structural steel coatings. This method follows the procedure used in ASTM D 4752-95 "Standard Test Method for Measuring MEK Resistance of Ethyl Silicate (Inorganic) Zinc-Rich Primers by Solvent Rub".

2. APPARATUS AND MATERIALS:

- 2.1. Test Panels (4 " x 8 ", cold rolled steel)
- 2.2. Micrometer adjustable film applicator (6" path width)
- 2.3. Wet film thickness notch gage
- 2.5. MEK (Methyl Ethyl Ketone)
- 2.6. Cheese Cloth
- 2.7. Squeeze Bottle
- 2.8. Solvent Resistant Gloves

3. PROCEDURE:

- 3.1. Apply properly mixed coating, of an appropriate wet film thickness, to a test panel using a micrometer adjustable film applicator. ([See Note 5.1](#))
- 3.2. Verify the wet film thickness of the applied coating.
- 3.3. Dry the specimen at $72^{\circ} \pm 5^{\circ}$ F and $50 \pm 10\%$ relative humidity for 24 hours.
- 3.4. Cure the dried specimen in an oven at $110^{\circ} \pm 5^{\circ}$ C for 24 hours.
- 3.5. Mark a section of the prepared specimen, measuring six (6) inches by one (1) inch with a solvent resistant marker.
- 3.6. Fold a twelve (12) inch square piece of cheese cloth so that the thickness is doubled and saturate until dripping wet with MEK. ([See Note 5.2](#))
- 3.7. Don solvent resistant gloves and place an index finger in the center of the cheese cloth and gather the remaining cloth.

3.8. With the index finger at a 45 degree angle to the surface, rub with moderate pressure over the marked area. Complete 150 double rubs. (See Note 5.3)

4. REPORT:

4.1. Document the applied wet film thickness.

4.2. Report the performance of the coating based on the table below.

Scale for Resistance Rating

<u>Resistance Rating</u>	<u>Description</u>
5	No effect on surface; no coating on cloth after 150 double rubs
4	Burnished appearance in rubbed area; slight amount of coating on cloth after 150 double rubs.
3	Some marring and apparent depression of the film after 150 double rubs.
2	Heavy marring; obvious depression in the film after 150 double rubs.
1	Heavy depression in the film but no actual penetration to the substrate after 150 double rubs.
0	Penetration to the substrate in 150 double rubs or less.

4.3. Acceptable coatings will not have any heavy marring or penetration of the coating. All coatings receiving a rating of 3 or greater will be accepted for project use.

5. NOTES:

- 5.1 Consult the coating manufacturers product data sheet for proper mixing procedures and application thickness.
- 5.2 Do not allow more than ten (10) seconds to elapse between wetting the cloth and beginning to rub the coating.
- 5.3 Wet the cloth as often as needed without lifting it from the surface. One forward and backward motion constitutes one double rub.

APPROVED

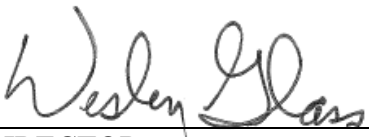

DIRECTOR
DIVISION OF MATERIALS

DATE

04/18/08

Kentucky Method 64-256-08
Revised 04/18/08
Supersedes KM 64-256-02
Dated 12/27/02

Kentucky Method 64-257-08
Revised 03/31/08
Supersedes KM 64-257-02
Dated 12/23/02

ANALYSIS FOR HINDERED AMINE LIGHT STABILIZER (HALS)

This method was discontinued March 2008. Its replacement is AASHTO TP66, "Analysis of Structural Steel Coatings for Hindered Amine Light Stabilizers (HALS)".

APPROVED

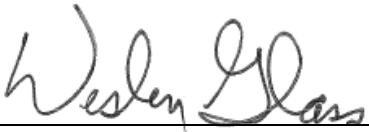

DIRECTOR
DIVISION OF MATERIALS

DATE

03/31/08

Kentucky Method 64-257-08
Revised 03/31/08
Supersedes KM 64-257-02
Dated 12/23/02

MEASUREMENT AND ACCEPTANCE OF FILM THICKNESS OF
STRUCTURAL STEEL COATINGS

1. SCOPE:

- 1.1. This method covers the requirements for obtaining film thickness measurements of structural steel coatings. It is intended to provide standards for field determinations of wet film thickness (WFT) of coatings using a notch gage and of dry film thickness (DFT) of coatings by means of destructive testing using a Tooke gage and non-destructive means using a type II magnetic gage.

2. REFERENCES:

- 2.1. ASTM D4414 Standard Practice for Measurement of Wet Film Thickness by Notch Gages.
- 2.2. ASTM D-4136 Standard Test Methods for Measurement of Dry Film Thickness of Protective Coating Systems by Destructive Means (Test Method A).
- 2.3. ASTM D-1186 Standard Test Methods for Nondestructive Measurement of Dry Film Thickness of Nonmagnetic Coatings Applied to a Ferrous Base (Test Method B).
- 2.4. SSPC PA-2 Measurement of Dry Coatings Thickness with Magnetic Gages.

3. DEFINITIONS:

- 3.1. WFT – Wet film thickness
- 3.2. DFT – Dry film thickness
- 3.3. Notch gage – Rigid metal gage with notched sides used to measure WFT of applied coatings.
- 3.4. Tooke gage – Instrument used to measure DFT by observation of angular cuts in the coatings through a microscope having a built-in illuminated reticle with a scale.
- 3.5. Overcoating project – Coatings projects requirement new coatings to be applied over properly prepared surfaces containing intact existing coatings.
- 3.6. Type II gage – Electronically operated instrument used to measure DFT utilizing a probe that houses a permanent magnet or coil energized by alternating current that is placed directly on the surface.
- 3.7. Control area – Sequentially identified areas of a structure enclosed with proper containment used to separate phases of work.

4. PROCEDURE A – MEASUREMENT OF WET FILM THICKNESS OF STRUCTURAL STEEL COATINGS:
 - 4.1. Wet film thickness (WFT) measurements shall be obtained for structural steel coatings with elongated curing schedules.
 - 4.2. Notch gages shall be used as described in ASTM D4414 to obtain WFT measurements
 - 4.3. Frequency and acceptance of WFT measurements shall be determined in accordance with Section 7.
5. PROCEDURE B – MEASUREMENT OF DRY FILM THICKNESS OF STRUCTURAL STEEL COATINGS BY DESTRUCTIVE MEANS:
 - 5.1. Dry film thickness (DFT) measurements for structural steel coatings applied on overcoating projects shall be obtained using destructive DFT testing.
 - 5.2. Tooke gages shall be used as described in ASTM D4136 (Method A) to obtain DFT measurements.
 - 5.3. Frequency and acceptance of destructive DFT measurements shall be determined in accordance with Section 7.
 - 5.4. Repair each measurement site by feathering the edges of each Tooke cut and reapplying each coating with respect to the manufactures stated recoat window.
6. PROCEDURE C – MEASUREMENT OF DRY FILM THICKNESS OF STRUCTURAL STEEL COATINGS BY NON-DESTRUCTIVE MEANS.
 - 6.1. Dry film thickness (DFT) measurements for structural steel coatings applied on projects requiring complete removal and replacement of existing coatings shall be obtained using non-destructive DFT testing.
 - 6.2. Type II magnetic gages shall be used as described in ASTM D1186 (Method B) to obtain DFT measurements.
 - 6.3. Frequency and acceptance for non-destructive DFT measurements shall be in accordance with SSPC PA-2 applied to each control area.
7. FREQUENCY AND ACCEPTANCE OF MEASUREMENTS:
 - 7.1. Obtain a minimum of five (5) arbitrarily selected measurements for each control area containing up to 5000 square feet of surface area..
 - 7.2. Obtain a minimum of one (1) arbitrarily selected measurement for each 1000 square feet or portion thereof for each control area containing greater than 5000 square feet of surface area.
 - 7.3. Each measurement obtained shall be with $\pm 25\%$ of the specified coatings application

range.

- 7.4 The average of all measurements taken within a control area shall be within the specified coatings application range.

8. CORRECTIVE ACTIONS:

- 8.1. In any area where unacceptable film thickness measurements are obtained either above or below the stated application range in accordance with 4.3, 5.3 or 6.3, obtain additional measurements to identify the extent of the unacceptable area.
- 8.2. With respect to 4.3 and 5.3, isolate areas of unacceptable film thickness by obtaining a minimum of an additional five (5) arbitrarily selected measurements, by the specified method, for each 1000 square feet of surface area or portion thereof within each affected control area.
- 8.3. Acceptance of film thickness measurements for each 1000 square feet of surface area or portion thereof of each affected control area shall be in accordance with Section 7.
- 8.4. With respect to 6.3, isolate areas of unacceptable film thickness in accordance to 4.1.4 of SSPC PA-2 applied to each control area.
- 8.5. Repair areas found to be below the acceptable stated application range by applying additional coating, with respect to manufacturers stated recoat window and surface preparation requirements.
- 8.6. Repair areas found to be above the acceptable stated application range by removing and replacing the unacceptable coating.
- 8.7. Verify the film thickness of each applied coating in any area requiring repair using the specified method of measurement.

9. REPORT:

- 9.1. Report the following for each coating application for each control area.
- 9.2. Square feet of surface area.
- 9.3. Manufactures recommended application range.
- 9.4. Each measurement obtained.

9.5. Average of all measurements obtained.

9.6. Location of any areas requiring corrective action and description of corrective actions employed.

APPROVED



DIRECTOR
DIVISION OF MATERIALS

DATE

03/07/08

Kentucky Method 64-258-08
Revised 03/07/08
Supersedes KM 64-258-05
Dated 08/11/05

TEST METHOD FOR ANALYSIS FOR AMINE CONTENT

1. SCOPE
 - 1.1 This method is designed to quantitatively determine the amine content of the amine component of two component structural steel coatings.
2. MATERIALS AND REAGENTS
 - 2.1 Mettler-Toledo DL50 titrator or equivalent
 - 2.2 Balance accurate to 0.001g
 - 2.3 High speed centrifuge
 - 2.4 Centrifuge tubes, 50 ml, disposable polypropylene
 - 2.5 Hot plate, with variable heat control
 - 2.6 Magnetic stirrer, adjustable speed
 - 2.7 Magnetic stirring bars, PTFE coated
 - 2.8 250 ml low-form beakers
 - 2.9 250 ml titration vessel
 - 2.10 Graduated cylinders, 10 ml, 100 ml
 - 2.11 Methylene chloride, reagent grade
 - 2.12 Isopropyl alcohol (99%), reagent grade
 - 2.13 Chloroform, reagent grade
 - 2.14 Hydrochloric acid, conc., reagent grade
 - 2.15 Hydrochloric acid, standard solution, 1.0 N
 - 2.16 Distilled water, ASTM D1193 Type II
 - 2.17 Sodium carbonate, reagent grade

3. PREPARATION OF STANDARD SOLUTIONS

3.1 Hydrochloric acid solution, 1.0 N:

Add 170 ml conc. Hydrochloric acid to 1000 ml distilled water in a 2L volumetric flask. Dilute to volume with distilled water and mix.

4. STANDARDIZATION OF 0.1 N HYDROCHLORIC ACID SOLUTION

4.1 Dry sodium carbonate to a constant weight in an oven at 110°C.

4.2 Weigh 0.53 g sodium carbonate to the nearest 0.001 g.

4.3 Dissolve sodium carbonate in 50 ml distilled water.

4.4 Using the titrator, titrate with the 1.0 N HCl to a pH of 3.5.

4.5 Record the ml of HCl used.

4.6 Calculate the normality of the HCl ([see 7.2](#)).

5. SAMPLE PREPARATION: Perform in duplicate

5.1 If the component to be tested is clear, it can be used in the method as is.

5.2 If the component to be tested is pigmented, the pigment must be removed..

5.2.1 Weigh 1.0 g of sample (to 0.001g) into a disposable polypropylene centrifuge tube.

5.2.2 Thin the sample with 3-4 ml methylene chloride; tap the bottom of the tube on the edge of the counter to disperse the sample.

5.2.3 Centrifuge the sample to produce a minimum relative centrifugal force (RCF) of 4200 for 30 minutes. [See 7.1](#) for calculation of RCF.

5.2.4 Transfer the supernatant to a 250 ml low-form beaker.

5.2.5 Re-disperse the pigment in the bottom of the centrifuge tube with 3-4 ml methylene chloride.

5.2.6 Centrifuge the sample again for 30 minutes as in 5.2.3.

5.2.7 Add this supernatant to the original supernatant for analysis.

6. PROCEDURE: (Perform in duplicate)

6.1 Weigh 1.0 g to nearest 0.001 g into a 250 ml low-form beaker or if pretreatment was necessary, use all the supernatant from that procedure.

- 6.2 Record the weight.
- 6.3 Add 90 ml chloroform and 10 ml isopropyl alcohol to the beaker.
- 6.4 Boil on a hot plate for 1 minute.
- 6.5 Cool to room temperature.
- 6.6 Pour contents into the 250 ml titration vessel.
- 6.7 Attach correct pH electrode (Mettler-Toledo DG111-SC).
- 6.8 Calibrate the pH electrode with standard pH 4.00 and pH 7.00 buffer solutions.
- 6.9 Attach burette and bottle assembly containing the standardized 1.0 N HCl solution to the titrator.
- 6.10 Bleed any air out of the burette and lines by putting titrator into “Dispense” mode and dispensing 5 ml while tapping on the burette and lines gently with a teflon stir stick. Repeat until there are no air bubbles.
- 6.11 Attach titration vessel containing the prepared sample to the titrator; add enough isopropyl alcohol so that the end of the electrode remains immersed in the solution.
- 6.12 Using user method “Amine” titrate the sample through the endpoint.
- 6.13 Record the volume of standardized 1.0 N HCl used to the nearest 0.001 ml.
- 6.14 Calculate the amine value (7.3).
- 6.15 After each titration the electrode, feed line and stirrer should be cleaned with isopropyl alcohol.
- 6.16 Soak the electrode in distilled water for 5 minutes before the next titration.
- 6.17 Titrate the duplicate sample.
- 6.18 Calculate the relative percent difference (RPD)(see 7.4).

7. CALCULATIONS

- 7.1 Calculation for Relative Centrifugal Force (RCF):

$$RCF = 0.00001118 \times r \times N^2$$

Where: r = radius of rotation
N = revolutions per minute (RPM)

7.2 Calculation for Normality of the HCl solution:

$$N=(W \times 1000)/(53 \times V)$$

Where: N = normality of the HCl solution
W = sodium carbonate used, g
V = HCl used, ml
53 = sodium carbonate equivalent weight

7.3 Calculation for the amine value:

$$\text{amine value} = (V \times N \times 56.1) / S$$

Where: V = HCl required to titrate the sample, ml
N = normality of the HCl solution
S = sample weight used, g

8. REPORT

- 8.1 Report the weights of the duplicate coating samples to the nearest 0.001 g.
- 8.2 Report the normality of the HCl solution.
- 8.3 Report the amine value in duplicate.
- 8.4 Results should be considered suspect if duplicate analyses differ by more than 2% relative percent difference when performed by a single analyst.

APPROVED

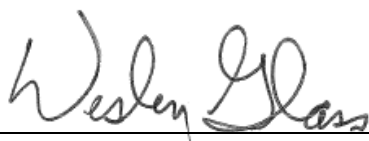

DIRECTOR
DIVISION OF MATERIALS

DATE

03/31/08

Kentucky Method 64-261-08
Dated 03/31/08

TEST METHOD FOR THE ANALYSIS OF BASE NUMBER

1. SCOPE

- 1.1 This method is designed for the determination of the titratable alkalinity (Base Number) of the resin system found in calcium sulfonate structural steel coatings.

2. MATERIALS AND REAGENTS

- 2.1 Balance accurate to 0.001g
- 2.2 Hot plate
- 2.3 Burette, 50 ml capacity with 0.1 ml graduations
- 2.4 Erlenmeyer flasks, 250 ml wide-mouth
- 2.5 Beakers, 250 ml
- 2.6 Volumetric flask, 100 ml
- 2.7 Class A 50 ml pipet
- 2.8 Buchner filter funnel, 83mm
- 2.9 Whatman 42 filter papers, 70 mm
- 2.10 Magnetic stir bar
- 2.11 Glass boiling beads
- 2.12 Acetic Acid, 0.2 N
- 2.13 Ammonium Hydroxide, 0.2 N
- 2.14 Heptane, reagent grade
- 2.15 Isopropyl Alcohol, reagent grade
- 2.16 Ethanol, reagent grade
- 2.17 Distilled water, ASTM D1193 Type II
- 2.18 Neutral red-Bromothymol blue mixed indicator

3. PREPARATION OF STANDARD SOLUTIONS

- 3.1 Neutral red-Bromothymol blue mixed indicator solution
0.05 g Neutral red and 0.05 g Bromothymol blue in 100 ml volumetric flask. Dilute to mark with ethanol and mix well.

4. SAMPLE PREPARATION

- 4.1 To a tared 250 ml Erlenmeyer flask add 1.0 g of sample. Record weight.
- 4.2 Effect solubility of the sample by the addition of 4 ml Heptane. Add glass boiling beads and swirl flask until sample is completely dissolved.
- 4.3 Pipet 50 ml 0.2N Acetic acid into flask.
- 4.4 Add 10 ml Isopropyl alcohol and 40 ml distilled water to the flask.
- 4.5 Place the flask on a hot plate and carefully bring to a boil for 5-10 minutes to distill the Heptane away.
- 4.6 Remove flask from hot plate and place in cool water bath; cool to room temperature.

5. TITRATION PROCEDURE

- 5.1 Add 10 drops Neutral red-Bromothymol blue mixed indicator to the flask.
- 5.2 Titrate to a gray (colorless) endpoint using 0.2N Ammonium Hydroxide (See Note 6.1).

6. NOTES

- 6.1 At the beginning, the solution will be rose colored. As the endpoint is approached the solution will turn colorless; this is the endpoint. If the sample is over-titrated the solution will turn a faint blue color.
- 6.2 For products with an expected Base Number of less than 150, increase sample size to 1.5-2.0 grams, and/or utilize 25 ml 0.2N Acetic acid.

7. CALCULATIONS

- 7.1 Calculation for Base Number:

$$\frac{[(\text{ml CH}_3\text{COOH} \times \text{N CH}_3\text{COOH}) - (\text{ml NH}_4\text{OH} \times \text{N NH}_4\text{OH})]}{\text{Sample wt}} \times 56.1 = \text{Base Number}$$

8. REPORT

8.1 Report the weights of the duplicate coating samples to the nearest 0.001g.

8.2 Report the duplicate Base Number results.

8.3 Results should be considered suspect if duplicate analyses differ by more than 5% RPD when performed by a single analyst.

APPROVED



DIRECTOR
DIVISION OF MATERIALS

DATE

03/31/08

Kentucky Method 64-262-08

Dated 03/31/08

TEST METHOD FOR ANALYSIS OF CALCIUM SULFONATE

1. SCOPE

- 1.1 This method is designed for the determination of the calcium sulfonate content of the resin system found in calcium sulfonate structural steel coatings.

2. MATERIALS AND REAGENTS

- 2.1 Balance accurate to 0.001g.
- 2.2 High speed centrifuge
- 2.3 Centrifuge tubes, plastic (polypropylene) with screw caps, 50 ml
- 2.4 Syringes, 10 ml with slip tips
- 2.5 Burette, 50 ml capacity with 0.1 ml graduations
- 2.6 Erlenmeyer flasks, 250 ml wide-mouth
- 2.7 Volumetric flasks, 50 ml and 1000ml
- 2.8 Class A pipets: 1,2,3,4,5 and 10 ml ([See 7.3](#))
- 2.9 Graduated cylinder, 50 ml
- 2.10 Sulfuric acid, 2.5M
- 2.11 Acid indicator solution ([See 3.1](#))
- 2.12 Standard Sodium Dodecyl Sulfate solution
- 2.13 Prepared Hyamine solution ([See 3.3](#))
- 2.14 Methylene Chloride, reagent grade
- 2.15 1:1 Heptane:Isopropyl Alcohol solution, reagent grade
- 2.16 Distilled water, ASTM D1193 Type II

3. PREPARATION OF STANDARD SOLUTIONS

- 3.1 Acid indicator solution
Dilute 40 ml of stock solution (Solution for anionic surfactant)

determination, formerly known as dimidium bromide-disulphine blue, BDH, [see 7.4](#)) with 400 ml of distilled water in a 1L volumetric flask and add 40 ml 2.5M sulfuric acid. Dilute to mark with distilled water and mix well.

3.2 Standard sodium dodecyl sulfate solution

Dry the sodium dodecyl sulfate @ 60°C for 2 hours, then cool in a dessicator. Accurately weigh 1.9-2.0 g sodium dodecyl sulfate to the nearest 0.001g and record weight. Dissolve in 500 ml distilled water in a 1L volumetric flask. Dilute to mark with distilled water and mix well.

3.3 Prepared Hyamine solution

Dissolve 1.37g Hyamine 1622 (benzethonium chloride) cationic surfactant(BDH, [see 7.4](#)) in 500 ml distilled water in a 1 L volumetric flask. Dilute to mark with distilled water and mix well.

4. STANDARDIZATION OF PREPARED HYAMINE SOLUTION

4.1 Pipet 10 ml of the standard sodium dodecyl sulfate solution into a 250 ml Erlenmeyer flask.

4.2 Add 20 ml methylene chloride and 40 ml acid indicator solution.

4.3 Titrate with the prepared Hyamine solution as described in [Section 6](#).

4.4 Calculate and record the molarity of the prepared Hyamine solution ([see 8.1](#)).

5. SAMPLE PREPARATION

5.1 To analyze a calcium sulfonate coating the pigment must first be removed.

5.2 Using a syringe weigh a 5g sample of the coating to the nearest 0.001 g into a centrifuge tube. Add 15 ml 1:1 heptane:isopropyl alcohol.

5.3 Tap tube on counter or use stir rod to disperse the coating into the solvent mixture. If a stir rod is used, rinse any residue back into the tube using 1:1 heptane:isopropyl alcohol.

5.4 Centrifuge the sample to produce a minimum relative centrifugal force (RCF) of 4200 until the pigment and resin system have been completely separated (approximately 30 min). [See 8.2](#) for calculation of RCF.

5.5 Pour the separated resin system into a labeled 50 ml volumetric flask.

5.6 Repeat the extraction procedure using only 10 ml

heptane:isopropyl alcohol. Add the separated resin system from these extractions to the volumetric flask.

- 5.7 Gently warm volumetric flask on a hotplate to ensure solubility of the resin system. **DO NOT BOIL**. Stopper and mix well.
- 5.8 Cool flask to room temperature. Fill to mark with the solvent mixture, stopper and mix well.
- 5.9 Prepare samples in duplicate.

6. TITRATION PROCEDURE

- 6.1 Pipet 3 ml of the prepared sample into a 250 ml Erlenmeyer flask (see 7.3).
- 6.2 Add 20 ml methylene chloride and 40 ml acid indicator solution to the flask.
- 6.3 Using a burette titrate the prepared sample solution with prepared Hyamine solution (see 7.1).
- 6.4 Swirl flask vigorously after each titrant addition. The lower solvent layer will be pink prior to the end point.
- 6.5 Titrate to a pale gray end point (see 7.2).
- 6.6 Record mls of prepared Hyamine solution used.
- 6.7 Calculate % active calcium sulfonate (8.3).
- 6.8 Calculate relative percent difference (RPD)(8.4).

7. NOTES

- 7.1 To start the titration , add about ½ of the expected volume of the prepared Hyamine solution needed to complete the titration from the burette. After a few titrations, you will know about how much to add. After this large initial addition dispense preprepare Hyamine solution in 1 ml increments.
- 7.2 As the end point is approached the pink color will become fainter. Reduce additions of prepared Hyamine solution to 0.1 ml. Titrate to a pale gray end point. The solvent layer will turn blue if the end point is exceeded.
- 7.3 The end point can be best observed and is sharpest when the volume of the prepared Hyamine solution used to reach the endpoint is between 10 and 20 ml. Since different coatings contain different amounts of active calcium sulfonate, you may have to pipet a larger or smaller aliquot from the diluted sample for titration. After the first titration, if the endpoint lies outside the optimal range alter the volume aliquoted for titration accordingly.

7.4 These specialty chemicals can be obtained through British Drug House (BDH).

8. CALCULATIONS

8.1 Calculation for Molarity of prepared Hyamine solution:

$$M = \frac{W \times 10}{V \times 288.38}$$

Where: M = Molarity of the prepared Hyamine solution (to 5 decimal places)

W = grams of sodium dodecyl sulfate used to prepare the standard solution

10 = volume in mls of standard sodium lauryl sulfate solution titrated

V = volume in mls of prepared Hyamine solution used

8.2 Calculation for Relative Centrifugal Force (RCF):

$$RCF = 0.00001118 \times r \times N^2$$

Where: RCF = Relative Centrifugal Force

r = Rotating Radius

N = Revolutions Per Minute

8.3 Calculation for % Active Calcium Sulfonate:

$$\% \text{ ACS} = \frac{V1 \times M \times 50 \times 470 \times 100}{W \times V2 \times 1000}$$

Where: V1 = volume in mls of prepared Hyamine solution used to titrate standard sodium dodecyl sulfate solution

M = molarity of the Hyamine solution (to 5 decimal places)

50 = dilution volume

470 = equivalent weight of calcium sulfonate

100 = factor to convert to percent

W = sample weight

V2 = volume in mls of the prepared sample

1000 = factor to convert liters to milliliters

8.4 Calculation for Relative Percent Difference (RPD):

$$\text{Reported \% Active Calcium Sulfonate(ACS)} = (\text{ACS a} + \text{ACS b})/2$$

Where: ACSa = % ACS from duplicate a

ACSb = % ACS from duplicate b

ACS = Average of duplicate results

Calculation for Relative Percent Difference:

$$RPD = [(ACSa-ACSb)/ACS] (100)$$

9. REPORT

9.1 Report the weights of the duplicate coating samples to the nearest 0.001g.

9.2 Report the %ACS in duplicate to the nearest 0.01%. Results should be considered suspect if duplicate analyses differ by more than 5% RPD when performed by a single analyst.

APPROVED

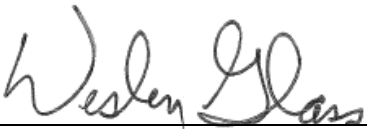

DIRECTOR
DIVISION OF MATERIALS

DATE

03/31/08

Kentucky Method 64-263-08
Dated 03/31/08

TEST METHOD FOR ANALYSIS OF EPOXY CONTENT

1. SCOPE

- 1.1 This method is designed to quantitatively determine the epoxy content of the epoxy component of two component structural steel coatings.

2. MATERIALS AND REAGENTS

- 2.1 Balance accurate to 0.001g
- 2.2 Burette, 10 ml capacity with 0.05 ml graduations
- 2.3 Graduated cylinder, 25 ml
- 2.4 Erlenmeyer flasks, 125 ml
- 2.5 Volumetric flasks, 50 ml
- 2.6 Magnetic stirrer, adjustable speed
- 2.7 Magnetic stirring bars, PTFE coated
- 2.8 High speed centrifuge
- 2.9 Centrifuge tubes, 50 ml, disposable polypropylene
- 2.10 Xylene, reagent grade
- 2.11 Chloroform-Chlorobenzene mixture (1:1), reagent grade
- 2.12 Crystal Violet indicator solution
- 2.13 Glacial Acetic Acid, reagent grade
- 2.14 Hydrogen Bromide (HBr), 30% by weight in acetic acid (approx. 5.78 N)
- 2.15 Potassium acid phthalate ($\text{KHC}_8\text{H}_4\text{O}_4$), primary standard grade
- 2.16 Potassium acid phthalate ($\text{KHC}_8\text{H}_4\text{O}_4$) 0.1N solution

3. PREPARATION OF STANDARD SOLUTIONS

- 3.1 Crystal Violet Indicator Solution:
Dissolve 0.1 g crystal violet in 100 ml glacial acetic acid.
- 3.2 Potassium acid phthalate ($\text{KHC}_8\text{H}_4\text{O}_4$) 0.1N solution:

Dry the potassium acid phthalate in an oven @ 110°C to a constant weight; cool in dessicator. Dissolve 1 g (weighed to 0.001 g) potassium acid phthalate in 25 ml of glacial acetic acid by gently heating. Record weight. Cool to room temperature.

4. STANDARDIZATION OF HYDROGEN BROMIDE SOLUTION

- 4.1 The 30% HBr solution should be standardized each day.
- 4.2 To the potassium phthalate solution (see 3.2) add 10 drops of crystal violet indicator solution.
- 4.3 Titrate the potassium acid phthalate solution with the 30 % HBr solution to a blue-green end point.

5. SAMPLE PREPARATION: (Perform in duplicate)

- 5.1 To a tared centrifuge tube add 5 g sample, and record weight to 0.001 g.
- 5.2 Thin the sample with 5 ml xylene.
- 5.3 Tap the bottom of the centrifuge tube on the side of the counter to disperse the sample.
- 5.4 Centrifuge the sample to produce a relative centrifugal force (RCF) of 4200 for 30 minutes. See 8.1 for calculation of RCF.
- 5.5 Transfer the supernatant to the 125 ml Erlenmeyer flask in which the titration will be performed.
- 5.6 Re-disperse the pigment in the bottom of the centrifuge tube with 5 ml of xylene.
- 5.7 Centrifuge the sample again for 30 minutes as in 5.4.
- 5.8 Add this supernatant to the original supernatant for analysis.

6. PROCEDURE: (Perform in duplicate)

- 6.1 To the supernatant in the 125 ml Erlenmeyer flask add 25 ml of a 1:1 mixture of chloroform and chlorobenzene.
- 6.2 Place a magnetic stirring bar into the flask and mix on the magnetic stirrer to dissolve; stir at a moderate speed to avoid splashing.
- 6.3 Add 10 drops of crystal violet indicator solution.
- 6.4 Titrate with the 30 % HBr in acetic acid solution to a blue-green endpoint with the stirrer rotating at a moderate speed to avoid splashing.

- 6.5 Slow down the titration near the endpoint to allow ample time for the reaction to take place (see 7.1).
- 6.6 Record the amount of titrant used.
- 6.7 Make a blank determination on the reagent in an identical manner.
- 6.8 Record the amount of titrant used for the blank determination.

7. NOTES

- 7.1 After each addition allow time for the reaction to take place. The endpoint is a blue-green color. When approaching the endpoint additions should be dropwise. If the solution turns yellow the sample has been over-titrated.

8. CALCULATIONS

- 8.1 Calculation for Relative Centrifugal Force (RCF):

$$\text{RCF} = 0.00001118 \times r \times N^2$$

Where: RCF = Relative Centrifugal Force
r = Radius of Rotation
N = Revolutions Per Minute (RPM)

- 8.2 Calculation for Normality of the 30% HBr in acetic acid:

$$N = (W \times 1000) / (204.2 \times V)$$

Where: W = potassium acid phthalate used, g
V = HBr solution used, ml

- 8.3 Calculation for weight per epoxy equivalent (grams of that component which contains one gram equivalent of epoxy groups):

$$\text{WPE} = 1000W / N(V-B)$$

Where: V = HBr solution used for titration of the sample, ml
B = HBr solution used to titrate the blank, ml
N = normality of the HBr solution
W = weight of the sample used, g

9. REPORT

- 9.1 Report the weights of the duplicate coating samples to the nearest 0.001g.
- 9.2 Report the Normality of the HBr solution.
- 9.3 Report the WPE in duplicate in grams.
- 9.4 Results should be considered suspect if duplicate analyses differ by more than 5% relative percent difference when performed by a single analyst.

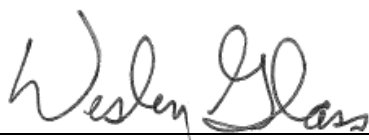
APPROVED 

DIRECTOR
DIVISION OF MATERIALS

DATE 03/31/08

Kentucky Method 64-264-08
Dated 03/31/08

Kentucky Method 64-265-19
Dated 05/10/19
Supersedes KM 64-265-08
Dated 03/07/08

TEST METHOD FOR INSOLUBLE RESIDUE IN
CARBONATE AGGREGATES

1. SCOPE: This method covers the routine analysis of “plus No. 200” aggregate intended for use in various highway construction projects and is a modification of Section 7 of ASTM D 3042, Standard Test Method for Insoluble Residue in Carbonate Aggregates.
 - 1.1. Aggregate field samples submitted for initial quarry qualification will be analyzed according to Section 5.1 of this method.
 - 1.2. Roadway samples (taken from paver during production), roadway cores, recycled asphalt pavement (RAP) and recycled asphalt shingles (RAS) will be analyzed according to Section 5.2 of this method.
2. DEFINITIONS:
 - 2.1. Field Samples – Aggregate samples taken from a quarry by the Department in order for a Source to maintain eligibility on the Department’s List of Approved Materials (LAM)
 - 2.2. Roadway Samples (taken from paver during production) – Aggregate samples taken from a specific project by the Department
3. APPARATUS:
 - 3.1. Sample splitter (1:1 split ratio)
 - 3.2. Analytical balance having a minimum capacity of 15 kg and meeting the requirements of ASTM D 4753, Class GP5
 - 3.3. Weighing pan or suitable container capable of holding 150 to 500 g of aggregate
 - 3.4. Heavy-walled 2000 mL Pyrex or borosilicate glass beaker
 - 3.5. 6 N Hydrochloric Acid (HCl)
 - 3.6. Oven of appropriate size, capable of maintaining a temperature of at $110 \pm 5^{\circ}\text{C}$
 - 3.7. Teflon-coated metal stirring rods of a length capable of safely stirring the material
 - 3.8. Watch glasses large enough to cover the Pyrex or borosilicate glass beakers
 - 3.9. Hot plate

- 3.10. Thermometer
 - 3.11. Sieves, U.S. standard 8-in. diameter with pan, conforming to ASTM E11 in the following sizes:
No. 50 and No. 200.
 - 3.12. Rubber policeman or other soft-tipped device (used to reduce agglomerated particles).
4. SAMPLE: Samples for analysis shall be prepared and supplied through the Aggregate Section of the Division of Materials.
 5. PROCEDURE:
 - 5.1 Aggregate field samples submitted for initial quarry qualification
 - 5.1.1. Field samples are to be analyzed in duplicate simultaneously.
 - 5.1.2. Use the sample splitter to split the sample a minimum of three times for each sample in order to obtain two samples of approximately $150 \text{ g} \pm 1.0 \text{ g}$ each.
 - 5.1.3. Tare a suitable container capable of holding $150 \text{ g} \pm 1.0 \text{ g}$, and add the aggregate from the first sample. Record the weight to the nearest 0.001 g. Repeat this process for the second sample.
 - 5.1.4. Transfer each sample to separate 2000-mL beakers.
 - 5.1.5. Place the beakers under a fume hood.
 - 5.1.6. Slowly add approximately 200 mL of 6 N HCl to each sample, and occasionally stir each beaker with the stirring rod until foaming subsides. Use precaution when adding acid. If the initial 200 mL causes excessive effervescence or foaming, add smaller quantities of acid until a total of 1000 mL of 6 N HCl has been added to each sample. Repeat the addition of 6 N HCl while stirring until a total of 1000 mL of 6 N HCl has been added to each sample.
 - 5.1.7. Place the beakers on a hot plate; cover the beakers with watch glasses, and heat them to a temperature between 70 and 80°C. Allow the samples to remain at this temperature for approximately one hour, stirring periodically during the heating cycle. Turn off the heat, and allow the samples to sit overnight.
 - 5.1.8. Move one beaker to the wash area. Wash the sample over stacked No. 50 and No. 200 sieves by first filling the beaker with tap water and using the stirring rod to stir the contents. Pour the contents over the stacked sieves. Rinse the beaker with water into the stacked sieves. Then rinse the stacked sieves until the rinse water is clear. Periodically during the rinsing process, rub the contents with a rubber policeman or a soft-tipped device to reduce any agglomerated particles.
 - 5.1.9. Allow the sieves to drain.

- 5.1.10. Put each stack of sieves on top of a bottom pan, and place them in the oven at $110 \pm 5^{\circ}\text{C}$ for a minimum of three hours. Remove the sieves from the oven, and allow them to cool to room temperature.
 - 5.1.11. Transfer the material from both the No. 50 and No. 200 sieves to a tared container.
 - 5.1.12. Place the sample and the tared container on the balance, and record the weight. Repeat the process for the duplicate sample.
 - 5.1.13. Calculate the percent insoluble retained according to Equation 1 in Section 6.1.
- 5.2. Quarry qualification, submitted roadway samples, roadway cores, recycled asphalt pavement (RAP) and recycled asphalt shingles (RAS) are to be analyzed in triplicate simultaneously.
- 5.2.1 Use the sample splitter to split the sample a minimum of three times for each of the three samples to obtain approximately $500 \text{ g} \pm 1.0 \text{ g}$ each.
 - 5.2.2. Tare a suitable container capable of holding $500 \text{ g} \pm 1.0 \text{ g}$, and carefully add the aggregate from the first sample. Record the weight to the nearest 0.001 g. Repeat this process for the second and third samples. If there is not enough material to test three samples, equally divide the material in order to obtain three samples. In doing so, the amount of acid will need to be adjusted using Equation 2 in Section 6.2.
 - 5.2.3 Place the beakers under a fume hood.
 - 5.2.4 Slowly add approximately 200 mL of 6 N HCl to each sample, and occasionally stir each beaker with the stirring rod until foaming subsides. Use precaution when adding acid. If the initial 200 mL causes excessive effervescence or foaming, add smaller quantities of acid until a total of 1000 mL of 6 N HCl has been added to each sample. Repeat the addition of 6 N HCl while stirring until a total of 1000 mL of 6 N HCl has been added to each sample.
 - 5.2.5 Allow the reaction to proceed. When the reaction appears to have stopped, decant the acid solution, and add approximately 300 mL of 6 N HCl if the initial sample weight was $500 \text{ g} \pm 1.0 \text{ g}$. If a smaller sample size is being analyzed, calculate the amount of 6 N HCl addition using Equation 3 in Section 6.3. Check for a reaction. If a reaction is observed, allow it to proceed to completion. Decant the acid solution, and add another 300 mL amount of 6 N HCl calculated using Equation 3 in Section 6.3. Repeat this process until no reaction is observed after acid addition.
 - 5.2.6 Place the beakers on a hot plate; cover the beakers with watch glasses, and heat to 100°C . Allow the samples to boil at this temperature for approximately one hour, stirring periodically during the heating cycle.
 - 5.2.7 Move one beaker to the wash area. Wash the sample over stacked No. 50 and No. 200 sieves by first filling the beaker with tap water and using the stirring rod to stir the contents. Pour the contents over the stacked sieves. Rinse the beaker with water into the

stacked sieves. Then rinse the stacked sieves until the rinse water is clear. Periodically during the rinsing process, rub the contents with a rubber policeman or a soft-tipped device to reduce any agglomerated particles.

5.2.8 Allow the sieves to drain.

5.2.9 Put each stack of sieves on top of a bottom pan, and place them in the oven at $110 \pm 5^{\circ}\text{C}$ for a minimum of three hours. Remove the sieves from the oven, and allow them to cool to room temperature.

5.2.10 Transfer the material from both the No. 50 and No. 200 sieves to a tared container.

5.2.11 Place the sample and the tared container on the balance, and record the weight. Repeat the process for the remaining samples.

5.2.12 Calculate the percent insoluble retained according to Equation 1 in Section 6.1.

6. CALCULATIONS:

6.1. Equation 1

Percent Insoluble Retained = (Weight of insoluble material/Initial sample weight) x100

6.2. Equation 2

Amount of HCl needed = (500 mL x grams of available material)/1000g

6.3. Equation 3

Amount of HCl needed = (300 mL x grams of available material)/1000g

7. REPORT: Total percent residue retained to the nearest 0.1 percent.

APPROVED

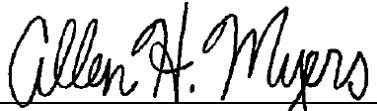

DIRECTOR
DIVISION OF MATERIALS

DATE

05/10/19

Kentucky Method 64-265-19

Dated 05/10/19

Supersedes KM 64-265-08

Dated 03/07/08

KM 64-265-19

PERFORMANCE BASED EVALUATION AND ACCEPTANCE
OF STRUCTURAL STEEL COATING SYSTEMS

1. SCOPE: This method outlines the process for submission of structural steel coating systems for approval for use on both new construction and maintenance structural steel coatings projects conducted by the Department.
2. SUBMISSION:
 - 2.1. Category I Submission Process:
 - 2.1.1. Coating systems shall be evaluated for performance through the National Transportation Product Evaluation Program (NTPEP) for Structural Steel Coatings. Submission of products through AASHTO/NTPEP is a continuous process. Manufacturers may submit systems at any time.
 - 2.2. Category II Submission Process:
 - 2.2.1. Coating systems shall be evaluated for performance through the University of Kentucky Transportation Center (UKTC). Manufacturers may submit systems at any time.
3. APPROVAL PROCESS: A submitted coating system will be given approval for each appropriate Class and Type for which the system meets the minimum established performance criteria.
 - 3.1. Class I: Coating systems submitted through Category I, utilizing zinc rich primers that meet the minimum performance acceptance criteria established by the Department. Class I coating systems are acceptable for use as fabrication shop applied primers to steel surfaces prepared by abrasive blasting to a minimum of a Society for Protective Coatings (SSPC) SP-10 / NACE No.2, Near White Metal Blast with fabrication shop applied or field applied intermediates and/or finish coats.

<i>Type I</i>	Three coat system using an epoxy based organic zinc rich primer
<i>Type II</i>	Three coat system using a urethane based organic zinc rich primer
<i>Type III</i>	Two coat system using an epoxy based organic zinc rich primer
<i>Type IV</i>	Two coat system using a urethane based organic zinc rich primer
<i>Type V</i>	Three coat system using an inorganic zinc rich primer
<i>Type VI</i>	Two coat system using an inorganic zinc rich primer

- 3.2. Class II: Coating systems submitted through either Category I or Category II, utilizing zinc rich primers that meet the minimum performance acceptance criteria established by the Department. Coating systems submitted through Category I meeting the established acceptance criteria for Class I, Types I through IV without regard to Slip Coefficient shall

be acceptable as Class II coatings systems. Class II coating systems are acceptable for use as field applied zinc rich primers to steel surfaces prepared by abrasive blasting.

<i>Type I</i>	Three coat system using an epoxy based organic zinc rich primer
<i>Type II</i>	Three coat system using a urethane based organic zinc rich primer
<i>Type III</i>	Two coat system using an epoxy based organic zinc rich primer
<i>Type IV</i>	Two coat system using a urethane based organic zinc rich primer

- 3.3. Class III: Coating systems submitted through Category I, utilizing non-zinc rich primers that meet the acceptance criteria established by the Department. Class III coating systems are acceptable for use as field applied coating systems to steel surfaces prepared by abrasive blasting.

<i>Type I</i>	Three coat system using an epoxy based primer
<i>Type II</i>	Three coat system using a urethane based primer
<i>Type III</i>	Three coat system using an acrylic based primer
<i>Type IV</i>	Two coat system using an epoxy based primer
<i>Type V</i>	Two coat system using a urethane based primer
<i>Type VI</i>	Two coat system using an acrylic based primer
<i>Type VII</i>	Two coat system using a long-oil alkyd based primer
<i>Type VIII</i>	Single coat system using a long-oil alkyd

- 3.4. Class IV: Coating systems submitted through Category II, utilizing non-zinc rich primers that meet the acceptance criteria established by the Department. Class IV coating systems are acceptable for use as field applied coating systems to steel surfaces prepared by means other than abrasive blasting.

<i>Type I</i>	Three coat system using an epoxy based primer
<i>Type II</i>	Three coat system using a urethane based primer
<i>Type III</i>	Three coat system using an acrylic based primer
<i>Type IV</i>	Two coat system using an epoxy based primer
<i>Type V</i>	Two coat system using a urethane based primer
<i>Type VI</i>	Two coat system using an acrylic based primer
<i>Type VII</i>	Two coat system using a long-oil alkyd based primer
<i>Type VIII</i>	Single coat system using a long-oil alkyd

- 3.5. Class V: Coating systems submitted through Category II, utilizing innovative technologies not defined in Classes I through IV that meet the acceptance criteria established by the Department. Acceptable use of Class V coating systems will be detailed through project specific special notes.

4. PERFORMANCE CRITERIA: Each of the following tables defines the acceptable performance criteria for the designated Class and Type of coating system. For each performance parameter, a minimum of two of the three evaluated specimen panels shall meet or exceed the stated acceptable performance criteria.

- 4.1. Class I, Types I through IV

<i>Performance Test</i>	<i>Performance Parameter</i>	<i>Performance Criteria</i>
Adhesion		
	Primer to Substrate	1000 PSI Minimum
	System to Substrate	1000 PSI Minimum
Thermal Cycling		
	Primer to Substrate	750 PSI Minimum
	System to Substrate	750 PSI Minimum
Cyclic Weathering		
5000 Hours Exposure	Rust Creep	5mm Average*
	Color Retention	Report*
	Gloss Retention	Report*
	Blistering	10
	Field Rusting	10
Salt Fog		
5000 Hours Exposure	Rust Creep	3mm Average*
	Blistering	10
	Field Rusting	10
Slip Coefficient		Class B Minimum
Atmospheric Weathering		
2 Years Exposure	Rust Creep	3mm Average*
	Color Retention	Report*
	Gloss Retention	Report*
	Blistering	10
	Field Rusting	10

4.2. Class I, Types V and VI

<i>Performance Test</i>	<i>Performance Parameter</i>	<i>Performance Criteria</i>
Adhesion		
	Primer to Substrate	1000 PSI Minimum
	System to Substrate	1000 PSI Minimum
Thermal Cycling		
	Primer to Substrate	750 PSI Minimum
	System to Substrate	750 PSI Minimum
Cyclic Weathering		
5000 Hours Exposure	Rust Creep	3mm Average*
	Color Retention	Report*
	Gloss Retention	Report*
	Blistering	10
	Field Rusting	10
Salt Fog		
5000 Hours Exposure	Rust Creep	2mm Average*
	Blistering	10
	Field Rusting	10
Slip Coefficient		Class B Minimum
Atmospheric Weathering		
2 Years Exposure	Rust Creep	3mm Average*

	Color Retention	Report*
	Gloss Retention	Report*
	Blistering	10
	Field Rusting	10

4.3. Class II, Types I through IV

<i>Performance Test</i>	<i>Performance Parameter</i>	<i>Performance Criteria</i>
Accelerated Performance		
5000 Hours Exposure	Rust Creep	5mm Average*
	Color Retention	Report*
	Gloss Retention	Report*
	Blistering	10
	Field Rusting	10

4.4. Class III, Types I through VI

<i>Performance Test</i>	<i>Performance Parameter</i>	<i>Performance Criteria</i>
Adhesion		
	Primer to Substrate	750 PSI Minimum
	System to Substrate	500 PSI Minimum
Thermal Cycling		
	Primer to Substrate	750 PSI Minimum
	System to Substrate	500 PSI Minimum
Cyclic Weathering		
5000 Hours Exposure	Rust Creep	15mm Average*
	Color Retention	Report*
	Gloss Retention	Report*
	Blistering	10
	Field Rusting	10
Salt Fog		
5000 Hours Exposure	Rust Creep	5mm Average*
	Blistering	10
	Field Rusting	10
Atmospheric Weathering		
2 Years Exposure	Rust Creep	5mm Average*
	Color Retention	Report*
	Gloss Retention	Report*
	Blistering	10
	Field Rusting	10

4.5. Class III, Types VII and VIII

<i>Performance Test</i>	<i>Performance Parameter</i>	<i>Performance Criteria</i>
Adhesion		
	Primer to Substrate	750 PSI Minimum
	System to Substrate	500 PSI Minimum

Thermal Cycling		
	Primer to Substrate	750 PSI Minimum
	System to Substrate	500 PSI Minimum
Cyclic Weathering		
5000 Hours Exposure	Rust Creep	5mm Average*
	Color Retention	Report*
	Gloss Retention	Report*
	Blistering	10
	Field Rusting	10
Salt Fog		
5000 Hours Exposure	Rust Creep	3mm Average*
	Blistering	10
	Field Rusting	10
Atmospheric Weathering		
2 Years Exposure	Rust Creep	3mm Average*
	Color Retention	Report*
	Gloss Retention	Report*
	Blistering	10
	Field Rusting	10

4.6. Class IV, Types I through VI

<i>Performance Test</i>	<i>Performance Parameter</i>	<i>Performance Criteria</i>
Accelerated Performance		
5000 Hours Exposure	Rust Creep	15mm Average*
	Color Retention	Report*
	Gloss Retention	Report*
	Blistering	10
	Field Rusting	10

4.7. Class IV, Types VII and VIII

<i>Performance Test</i>	<i>Performance Parameter</i>	<i>Performance Criteria</i>
Accelerated Performance		
5000 Hours Exposure	Rust Creep	5mm Average*
	Color Retention	Report*
	Blistering	10
	Field Rusting	10

4.8. Class V

<i>Performance Test</i>	<i>Performance Parameter</i>	<i>Performance Criteria</i>
Accelerated Performance		
5000 Hours Exposure	Rust Creep	*
	Color Retention	Report*
	Gloss Retention	Report*
	Blistering	10

	Field Rusting	10
--	---------------	----

* Values are assigned as target values and are subject to change pending accelerated weathering performance of submitted systems with known field performance characteristics within Kentucky.

5. REMOVAL PROCESS: Coating systems may be removed from the Departments List of Approved Materials based on any of the following requirements. Coating systems removed from the List of Approved Materials shall not be eligible for re-submission for one calendar year from the date of removal.
 - 5.1. Verification Testing: Rejection of any three (3) lots of any product within a single calendar year shall constitute grounds for removal of all approved coating systems containing the rejected product.
 - 5.1.1. Appropriate chemical and physical properties will be verified for compliance to Section 821 of the [Kentucky Standard Specifications](#) for each product of a coating system delivered for use. The target value for each property evaluated shall be established from data obtained through the selected submission process. Appropriate differences in chemical and physical properties related to change of finish coat color to meet Kentucky project specifications shall be given consideration. The manufacturer shall be notified in writing of each rejection of each product.
 - 5.2. Requalification Testing (Category I Submissions): Failure to comply with the requalification requirements set forth under the AASHTO/NTPEP Structural Steel Coatings Technical Committee and maintain compliance to the applicable established acceptance criteria.
 - 5.2.1. Requalification data for chemical and physical properties of each product within a submitted system shall meet the Specification Acceptance Range as defined in Section 821 of the Kentucky Standard Specifications. Requalification data for performance characteristics of submitted systems shall meet the applicable requirements of this method.
 - 5.3. Field Performance Evaluation: Failure of the coating system to be suitably applied within the recommendations of the coating manufacturer or failure of the coating system to provide a durable protective product.

APPROVED

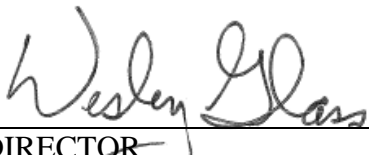

 DIRECTOR
 DIVISION OF MATERIALS

DATE

05/09/08

Kentucky Method 64-266-08
Dated 05/09/08

QUALIFICATIONS OF MONITORING SYSTEMS FOR PAVEMENT MARKINGS APPLICATION VEHICLES

1. SCOPE

- 1.1 This method covers the qualification requirements for monitoring systems of striping vehicles used to apply longitudinal lane markings to roadway surfaces (striping trucks) to assure adequate measures are used to monitor and record application properties of installed lane markings.
- 1.2 This method will be used for qualification of monitoring systems for each striping vehicle used to apply waterborne striping paint on KYTC District Wide Striping contracts.
- 1.3 This method does not purport to address all of the safety concerns, or any associated with its use. It is the responsibility of the user of this method to establish appropriate safety and health practices and determine the applicability of regulatory limitations prior to use.

2. BASIC REQUIREMENTS

- 2.1 Striping vehicle calibrated and maintained in operational condition.
- 2.2 Waterborne or durable waterborne striping paint with manufacturers certification of compliance to Section 842 or Section 846, as appropriate, of the [Kentucky Standard Specifications](#).
- 2.3 Beads of the gradation and coating(s) preference of the contractor intended to be utilized to meet the minimum retroreflectivity requirements of the contract.
- 2.4 Provide adequate location to verify distance monitoring devices.
- 2.5 Label each material container and monitoring system with a unique identification.

3. QUALIFICATION PROCEDURES

- 3.1 General
 - 3.1.1 Qualification and certification of calibration must be obtained annually, after January 1 of the contract year and prior to use of the striping vehicle for application of lane markings.
 - 3.1.2 Certification procedures shall be conducted by a licensed independent commercial scale calibration company.
 - 3.1.3 Qualification procedures and verifications shall be conducted by the Department.

3.1.4 Documentation of all measurements made for certification and qualification processes shall be reported on forms approved by the Department.

3.2 Weight monitoring system.

3.2.1 Obtain certification of weight monitoring systems prior to qualification of the monitoring system for a striping vehicle.

3.2.2 Obtain certification of calibration for each weight monitoring system installed on the striping vehicle.

3.2.2.1 Obtain certification of calibration from an independent commercial scale calibration company licensed through the Kentucky Department of Agriculture, [Division of Regulation and Inspection](#).

3.2.2.2 Determine the maximum working load of the system and divide into 10 uniform test intervals. Perform calibration of the system using certified Class F test weights conforming to NIST Handbook 105 at each identified interval.

3.2.2.3 Appropriate materials (paint or beads) may be utilized to apply build up loads equal to the displayed weight of the previous interval.

3.2.2.4 Indicated weight displayed by the data logger must be within 3% of the actual load.

3.2.2.5 Difference between indicated weights displayed by the data logger for consecutive intervals must be within 3% of the actual interval test load.

Example:

Tank capacity: 15,000 lbs.

Interval test load: 1,500 lbs.

Interval	Cert. Weight (CW)	Previous Displayed Load (Build-Up)	Actual Test Load (ATL)	Displayed Weight (DW)	Load Deviation (LD) = (ATL-DW)	% Load Deviation = ((ABS)LD/ATL) *100	Interval Deviation (ID) =CW-(DW-Previous DW)	% Interval Deviation = ((ABS)ID/CW)*100
0	0	0	0	0	0	0	-	-
1	1500	0	1500	1475	25	1.7	25	1.7
2	1500	1475	3000	2970	30	1.0	5	0.3
3	1500	2970	4500	4482	18	0.4	-12	0.8
...

BS = Absolute Value

3.3 Volume monitoring system (Stroke counter)

3.3.1 Obtain a sample of the paint to be used for qualification testing.

3.1.1 Determine the density of the sample in accordance with ASTM D1475.

- 3.3.2 Load the system with a suitable quantity of paint.
 - 3.3.2.1 Adjust the system to operating conditions and dispense a sufficient quantity of paint to ensure a continuous flow of material.
- 3.3.3 Zero the monitoring system.
- 3.3.4 Operate the system to dispense a minimum of 15 gallons of paint into an appropriately sized and tared container. Record the number of pump strokes made to dispense the material.
 - 3.3.4.1 Weigh the collected sample and determine the actual quantity of material dispensed in gallons.
 - 3.3.4.2 Calculate the scaling factor for system.
 - 3.3.4.3 Verify the number of pump strokes recorded by the monitoring system.
 - 3.3.4.4 Document the established scaling factor for the system and compare to the calculated scaling factor.
 - 3.3.4.5 Indicated volume displayed by the data logger must be within 3% of the actual volume dispensed.
- 3.4 Distance monitoring system (Electrical foot counter)
 - 3.4.1 Establish a straight-line distance using a suitable measuring device.
 - 3.4.2 Zero the monitoring system.
 - 3.4.3 Operate the striping vehicle for the established distance.
 - 3.4.3.1 Verify the distance recorded by the monitoring system.
 - 3.4.3.2 Indicated distance displayed by the data logger must be within 0.3% of the actual distance traveled.
- 3.5 Temperature monitoring system (Ambient, Surface, and Material)
 - 3.5.1 Obtain an appropriate temperature measurement using an NIST Traceable temperature measuring device.
 - 3.5.2 Obtain appropriate temperature measurement using the installed temperature measuring device.
 - 3.5.2.1 Verify the temperature measurement recorded by the monitoring system.

3.5.2.2 Indicated temperature displayed by the data logger must be within 2° F of the actual temperature.

3.6 Other monitoring systems

3.6.1 Monitoring systems not described herein shall be inspected for qualification upon notification to the Department.

4. FIELD VERIFICATION

4.1 The Department reserves the right to perform field verifications of qualified monitoring systems.

4.2 The Department reserves the right to perform field verifications to determine compliance to all stated application properties within the contract.

5. DISQUALIFICATION

5.1 Striping vehicles found to be out of tolerance (monitoring system for weight, volume, distance, or temperature) shall be disqualified.

5.2 Removal or replacement of any component of a monitoring system shall result in disqualification of the striping vehicle.

5.3 Disqualified striping vehicles will not be permitted to return to service until approved by the Department.

6. RECORD KEEPING

6.1 Quality control and verification checks performed by the contractor during production shall be documented and maintained. If requested, these records shall be provided to the Department.

APPROVED William Broyles
DIRECTOR
DIVISION OF MATERIALS

DATE 01/15/10

Kentucky Method 64-267-10
Dated 01/15/10

Kentucky Method 64-268-24
Dated 3-15-24
Supersedes KM 64-268-20
Dated 02/27/20

TEST METHOD FOR THERMOPLASTIC PAVEMENT MARKING MATERIALS

1. SCOPE

- 1.1 This test procedure outlines the processes associated with sampling, sample preparation, testing, and data reporting for white and yellow thermoplastic pavement marking materials for project acceptance.
- 1.2 This test procedure is applicable for both extruded and spray thermoplastic formulations.

2. REFERENCED DOCUMENTS

- 2.1 Kentucky Standard Specifications – Section 837
- 2.2 ASTM D 4797 Standard Test Methods for Gravimetric Analysis of White and Yellow Thermoplastic Pavement Marking
- 2.3 AASHTO T250 Standard Method of Test for Thermoplastic Traffic Line Material

3. MATERIALS

- 3.1 Quart Metal Cans
- 3.2 Forced Air Oven (Vented)
- 3.3 Muffle Furnace (Vented)
- 3.4 Stainless Steel Spatula (One Per Color)
- 3.5 High Temperature Gloves
- 3.6 Timing Device
- 3.7 Aluminum Weighing Dishes
- 3.8 30ml Porcelain Crucibles
- 3.9 400ml Beakers
- 3.10 Concentrated Hydrochloric Acid (HCl)
- 3.11 Stainless Steel Tongs
- 3.12 Acetone
- 3.13 Aluminum Pin Cups (XRF)
- 3.14 Utility Knife
- 3.15 Heavy Duty Manual Can Opener
- 3.16 Heavy Plastic Sample Bags
- 3.17 Towel
- 3.18 Hammer

4. PROCEDURE FOR PRODUCTION SAMPLES TAKEN BY THE MANUFACTURER
 - 4.1 Manufacturer samples should be sampled and tested in accordance with Section T 250.
 - 4.2 The manufacturer's material certification should be supplied with the material delivered to the project in compliance with Section 837 of the Standard Specifications for Road and Bridge Construction.

5. PROCEDURE FOR FIELD SAMPLES TAKEN BY THE DEPARTMENT
 - 5.1 Sample Preparation (Prepare Duplicates)
 - 5.1.1 Remove the friction closure rings from two (2) quart metal cans using a heavy duty manual can opener.
 - 5.1.2 Place the thermoplastic sample on a solid surface and break apart using a hammer.
 - 5.1.3 Place pieces of the thermoplastic sample into a quart can prepared in section 5.1.1 of this method. Repeat sampling until approximately 800 g have been obtained for each duplicate.
 - 5.1.4 Record the sample identification number assigned by the Department (Sample ID), the manufacturer's batch number and the duplicate number on each can.
 - 5.1.5 Fill an aluminum weighing dish with a portion of the material for Fourier Transform Infrared Spectroscopy (FTIR) analysis.
 - 5.1.6 Heat the quart cans containing samples in a forced air vented oven at $217 \pm 2^{\circ}\text{C}$ for four (4) hours. Use high temperature gloves and a stainless steel spatula to thoroughly stir the sample every 15 minutes. Make sure to scrape the bottom and the sides of the container to prevent scorching of the material. Note: Most formulations begin to melt between 15 and 30 minutes.
 - 5.2 Titanium Dioxide and Lead Analysis
 - 5.2.1 After heating the sample in accordance with Section 5.1.6 for one (1) hour, thoroughly stir the sample and pour into two (2) aluminum pin cups. Fill the aluminum pin cups level to the top and allow the samples to cool to room temperature. Label with their associated Sample ID and duplicate numbers and send to the X-Ray Fluorescence (XRF) instrument for analysis. White thermoplastic samples should be analyzed for titanium dioxide and yellow thermoplastic samples should be analyzed for lead.

5.2.2 Samples prepared for the XRF shall be tested in duplicate against a calibration curve created with a minimum of the following standard concentrations of titanium dioxide:

- 6.00%
- 8.00%
- 10.00%
- 12.00%

5.3 Binder Content

5.3.1 After heating the sample in accordance with Section 5.1.6 with the exception that the binder sample only needs to be in the oven for approximately one hour or until the sample material is completely melted, thoroughly stir the sample and pour into two (2) aluminum weighing dishes level with the top and allow the binder samples to cool to room temperature.

5.3.2 Label and pre-weigh two (2) 30 mL crucibles.

5.3.3 Wrap each binder sample in a towel to prevent sample loss and place on a solid surface and break the sample into small pieces using a hammer.

5.3.4 Weigh 20.0 g of each duplicate into a pre-weighed crucible. Record the weight of each duplicate to the nearest 0.0001 g.

5.3.5 Ignite the binder sample in the vented muffle furnace at 540°C for one (1) hour, or until no carbonaceous material remains.

5.3.6 Remove the crucibles from the muffle furnace and cool to room temperature in a desiccator.

5.3.7 Weigh each binder sample to the nearest 0.0001 g, record weight and calculate the percent binder in each sample according to Equation 1.

5.4 Intermix Glass Bead Content

5.4.1 Label and pre-weigh 400 mL beakers.

5.4.2 Transfer the ignited crucible and residue from 5.3.7 into the 400 mL beakers. Add 25 mL of concentrated HCl to each crucible to dissolve the residue. Repeat HCl additions until effervescence stops. Use tongs to remove the crucible from the beaker. Rinse the contents of the crucible into the beaker. Ensure all residue has been removed from the crucible. Carefully dilute with distilled water and allow the beads to settle. Repeat for the duplicate.

5.4.3 Decant the diluted acid. Rinse the beads with distilled water until clear water is decanted. Use acetone for a final rinse of the beads and decant. Repeat for the duplicate. Dry the beakers and beads in the vented forced air oven at 110°C ± 2°C for one (1) hour.

- 5.4.4 Remove the beakers from the drying oven and cool to room temperature in a desiccator.
 - 5.4.5 Weigh each bead sample to the nearest 0.0001 g, record the weight and calculate the percent intermix glass bead content in each duplicate according to Equation 2.
- 5.5 Color
- 5.5.1 After heating in accordance with Section 5.1.6 for four (4) hours, thoroughly stir the sample and pour into two (2) aluminum weighing dishes. Fill the aluminum dish level with the top. Allow the samples to cool to room temperature.
 - 5.5.2 Label the top surface of the color sample with the Sample ID and date.
 - 5.5.3 Calibrate the Hunter Lab Scan XE instrument using the 0.5" port. The spectrophotometer should be set to use 45° illumination and 0° viewing with a 2° observer.
 - 5.5.4 Remove the aluminum dish and make triplicate readings using the bottom surface of the sample.
 - 5.5.5 Record the L*, a*, b* and ΔE^* values for both illuminant D65 and illuminant A for each color sample.
- 5.6 Fourier Transform Infrared Spectroscopy (FTIR)
- 5.6.1 Load the diffuse reflectance test method and sample holder.
 - 5.6.2 Collect a background using the stainless steel background sample.
 - 5.6.3 Use a spatula to fill the sample cup with granular material as prepared in Section 5.1.5 and strike off excess material.
 - 5.6.4 Load the sample into the sample holder, close the sample chamber and allow the chamber to purge.
 - 5.6.5 Collect the sample spectra and compare with standard spectra. Repeat for duplicate samples.
 - 5.6.6 Analyze the spectra for peaks consistent with the standard spectra and record the percent match to the standard spectra.

6. CALCULATIONS

6.1 Equation 1

$$\% \text{ Binder} = (W2 - (W3 - W1)/W2) \times 100$$

Where:

W1 = Weight of crucible

W2 = Weight of binder sample

W3 = Weight of crucible and sample after ignition

6.2 Equation 2

$$\% \text{ Intermix Bead Content} = ((W3 - W1)/W2) \times 100$$

Where:

W1 = Weight of beaker

W2 = Weight of binder sample

W3 = Weight of beaker and sample after drying

7. REPORT

- 7.1 Report % Titanium Dioxide in duplicate to the nearest 0.01%. Results should be considered suspect if duplicate analyses differ by more than 0.25%.
- 7.2 Report % Binder in duplicate to the nearest 0.01%. Results should be considered suspect if duplicate analyses differ by more than 0.50% when performed by an analyst.
- 7.3 Report % Beads to the nearest 0.01%. Results should be considered suspect if duplicate analyses differ by more than 1.30% when performed by a single analyst.
- 7.4 Report Color in duplicates for illuminants D65 and A to the nearest 0.01 ΔE^* . Results should be considered suspect if duplicate analyses differ by more than 0.50 ΔE^* .
- 7.5 Report % match for FTIR in duplicates. FTIR results should be evaluated more closely to determine differences between the sample spectra and the standard spectra if they do not match to a minimum coefficient of 0.95 or if duplicate sample spectra do not match to a minimum coefficient of 0.98.

APPROVED

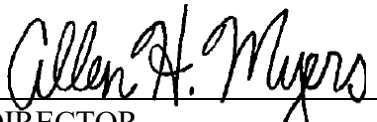

DIRECTOR
DIVISION OF MATERIALS

DATE

3-15-24

Kentucky Method 64-268-24

Dated 3-15-24

Supersedes KM 64-268-20

Dated 02-27-20

**PERFORMANCE BASED EVALUATION AND ACCEPTANCE CRITERIA
OF CONCRETE COATINGS SYSTEMS FOR INCLUSION ON THE LIST OF APPROVED
MATERIALS**

1. **SCOPE:** This method outlines the process for submission of concrete coating systems for inclusion on the list of approved material. Data gathered during the submission process will be used to evaluate approved material when used in Kentucky on both new construction and maintenance concrete coating projects conducted by the Department.

2. **SUBMISSION:**
 - 2.1. **Category I Submission Process:**
 - 2.1.1. Coating systems shall be evaluated for performance through the National Transportation Product Evaluation Program (NTPEP) for Concrete Coatings.

 - 2.2. **Category II Submission Process:**
 - 2.2.1. Coatings Systems shall be evaluated for performance through the University of Kentucky Transportation Center (UKTC).

3. **PERFORMANCE CRITERIA:** The following table defines the acceptable performance criteria for both Category I and Category II. For each applicable performance parameter, a minimum of two of the three specimen panels shall meet or exceed the stated acceptable performance criteria.

<i>Performance Test</i>	<i>Performance Parameter</i>	<i>Performance Criteria</i>
Adhesion (D 7234)		
	Primer to Substrate	400 PSI Minimum
	System to Substrate	400 PSI Minimum
Cyclic Weathering (D 4587)		
2504 Hours Exposure	Color	Report*
	Color Retention	2.0 ΔE
	Gloss	Report*
	Gloss Retention (%)	Report*
	Blistering	10 (No Blistering)
	Fungal Resistance	10 (No fungal growth)
	Efflorescence	None
Laboratory		
(D 1475)	Mass Per Volume (g/L)	Report*
(D 562)	Viscosity Stormer (KU)	Report*
(D 2196)	Viscosity Brookfield (cPs)	Report*

(D 2697)	Solids by Mass (%)	Report*
(D 3960)	VOC (g/L)	450 g/L Maximum
(D 6133)	Exempt Solvents	Report*
(D 4017)	Water Content (%)	Report*
	VOC (g/L) – adjusted for exempt solvents	Report*
(D 2697)	Solids by Volume (%)	Report*
(D 2698/D 3723)	Pigment (%)	Report*
(D 1652)	Epoxide Value	Report*
(D 2074)	Amine Value	Report*
(TP 67)	Isocyanate (%)	Report*
(TP 66)	Hindered Amine Light Stabilizer (HALS)	Report*
	Pot Life (hrs)	Report*
(D 4400)	Sag Resistance (mils)	Report*
(D 1640)	Dry to Touch (Min)	Report*
(D 1640)	Dry to Handle (Hrs)	Report*
(D 1640)	Dry to Recoat (Hrs)	Report*
(40 CFR 261)	Total Lead (ppm)	Report*
(40 CFR 261)	Total Chromium (ppm)	Report*
(40 CFR 261)	Total Cadmium (ppm)	Report*
(40 CFR 261)	TCLP (ppm) Mixed Product – Arsenic Mixed Product – Barium Mixed Product – Cadmium Mixed Product – Chromium Mixed Product – Lead Mixed Product – Mercury Mixed Product – Selenium Mixed Product - Silver	Report*
	FTIR Spectroscopy Mixed Product Component A Component B	Report*
	Mixing Ratio (By Mass)	Report*
	Mixing Ratio (By Volume)	Report*

*Reported values shall be used as target values for compliance to Section 821 of the Standard Specifications for Road and Bridge Construction and are subject to change pending known field performance characteristics within Kentucky.

4. REMOVAL PROCESS: Coating systems may be removed from the Department’s List of Approved Materials based on any of the following requirements. Coating systems removed from the List of Approved Materials shall not be eligible for re-submission for one calendar year from the date of removal.

4.1. Verification Testing: Rejection of any three (3) lots of any product within a single calendar year shall constitute grounds for removal of all approved coating systems containing the rejected product.

4.1.1. Appropriate chemical and physical properties will be verified for compliance to applicable contracts, proposals and the Kentucky Standard Specifications for each product of a coating system delivered for use. The target value for each property evaluated shall be established from data obtained through the selected submission process with the exception of color, which shall be based on target values established in the Kentucky Standard Specifications or as outlined in the contract or proposal. Appropriate differences in chemical and physical properties related to change of finish coat color to meet Kentucky project specifications shall be given consideration. The manufacturer shall be notified in writing of rejection of a coating system.

4.2. Requalification Testing: Requalification data for chemical and physical properties of each product within a submitted system shall meet the Specification Acceptance Range as defined in the Kentucky Standard Specifications or as outlined in the contract or proposal. Requalification data for performance characteristics of submitted systems shall meet the applicable requirements of this method.

4.2.1. Category I Submissions: Failure to comply with the requalification requirements set forth under the AASHTO/NTPEP Concrete Coatings Technical Committee and maintain compliance to the applicable established acceptance criteria shall result in removal from the Department's List of Approved Materials.

4.3. Field Performance Evaluation: Failure of the coating system to be suitably applied within the recommendations of the coating manufacturer or failure of the coating system to provide a durable protective product shall result in removal from the Department's List of Approved Materials.

APPROVED

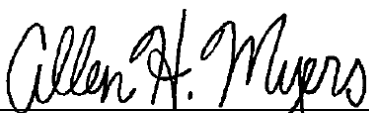

DIRECTOR
DIVISION OF MATERIALS

DATE

09/23/19

Kentucky Method 64-269-19
Dated 09/23/19

Kentucky Method 64-301-08
Revised 02/22/08
Supersedes KM 64-301-03
Dated 02/17/03

SAMPLING FRESH CONCRETE

Obtain sample according to ASTM C-172 with the following exceptions:

1. Sample fresh concrete from delivery units in accordance with [KM 64-113](#), Sampling Materials By Random Number Sampling
2. When concrete pumps or belt delivery systems are used, accomplish sampling simultaneously with placement at the discharge of the conveying equipment without stopping the flow of concrete to the area of work.
3. Do not perform the slump test on concrete from a continuous mixer (concrete mobile) until 4 or 5 minutes after its discharge from the mixer.

APPROVED

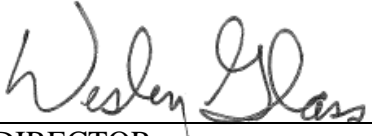

DIRECTOR
DIVISION OF MATERIALS

DATE

02/22/08

Kentucky Method 64-301-08
Revised 02/22/08
Supersedes KM 64-301-03
Dated 02/17/03

Kentucky Method 64-302-08
Revised 02/22/08
Supersedes KM 64-302-05
Dated 01/04/05

SLUMP OF PORTLAND CEMENT CONCRETE

Perform Test procedure according to ASTM C-143 with the following exceptions:

1. Obtain the sample in accordance with [KM 64-301](#), Sampling Fresh Concrete.
2. Do not perform the slump test on concrete from a continuous mixer (concrete mobile) until 4 or 5 minutes after its discharge from the mixer.

APPROVED

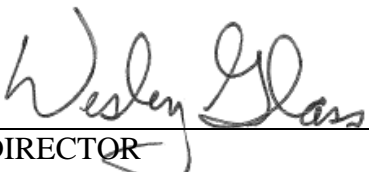

DIRECTOR
DIVISION OF MATERIALS

DATE

02/22/08

Kentucky Method 64-302-08
Revised 02/22/08
Supersedes KM 64-302-05
Dated 01/04/05

Kentucky Method 64-303-08
Revised 02/22/08
Supersedes KM 64-303-02
Dated 12/13/01

AIR CONTENT OF FRESHLY MIXED CONCRETE
BY THE PRESSURE METHOD

Perform Test procedure according to ASTM C-231 with the following exceptions:

1. Obtain sample in accordance with [KM 64-301](#), Sampling Fresh Concrete.
2. The aggregate correction factor for limestone coarse aggregate is 0.2% and for gravel coarse aggregate, 0.4%. Subtract the aggregate correction factor from the dial reading for the type coarse aggregate used.
3. [See appendix for alternate calibration procedure.](#)
4. Meters shall be calibrated on an annual basis or more frequently if there is a question about accuracy.

APPROVED 

DIRECTOR
DIVISION OF MATERIALS

DATE 02/22/08

Kentucky Method 64-303-08
Revised 02/22/08
Supersedes KM 64-303-02
Dated 12/13/01

Attachment

CALIBRATION OF THE "WATTS AIR METER"

Alternative Calibration---

An alternate method of calibration utilizes a device, namely Cali-Can, which replaces 5% of the water necessary to fill a 1/4ft³ bucket. This device eliminates the tubes and measure used in the original procedure.

However, this device shall be calibrated yearly by comparing to the original procedure. The variation between the original procedure and the Cali-Can should be no more than ± 0.2 %.

The Cali-Can is very useful for on-site calibration checks and is advantageous when calibrating numerous air meters.

The procedure is as follows:

1. Fill base with water. Clamp on cover. With both petcocks open, add water with a syringe through one petcock until all air is forced out opposite petcock. Leave both petcocks open.
2. Pump up air pressure to a little beyond the predetermined initial pressure line. Wait approximately 2 minutes for compressed air to cool to normal temperature and then stabilize the gauge hand at the proper initial pressure line by pumping or bleeding off as needed.
3. Close both petcocks and immediately press down on the thumb lever exhausting air into the base. Wait a few seconds until the hand is stabilized. If all the air was eliminated and the initial pressure line was correctly selected, the gauge should read 0%. If two or more tests show a consistent variation from 0%, then change initial pressure line to compensate for the variation. Use the newly established "initial pressure" line for subsequent tests.
4. Remove cover and place the calibration canister upright at the bottom of the already filled meter base. Replace cover on the base and top off with water.
5. With petcocks open, pump air pressure in exact manner as in paragraph 2. Close petcocks and immediately press the thumb lever. Wait a few seconds for exhaust air to warm to normal temperature and for the needle to stabilize. The dial should now read 5%.
6. If two or more consecutive tests show that the gauge reads incorrectly at 5% air (in excess of 0.2%) remove gauge glass and reset the dial hand to 5% by turning the calibrating screw located just below and to the right of the center dial.
7. After any adjustments, repeat procedure.

Kentucky Method 64-304-08
Revised 02/21/08
Supersedes KM 64-304-03
Dated 02/12/03

AIR CONTENT OF FRESHLY MIXED CONCRETE BY THE VOLUMETRIC METHOD

Perform test procedure according to ASTM C-173 with the following exception:

1. Obtain sample in accordance with [KM 64-301](#), Sampling Fresh Concrete.

APPROVED

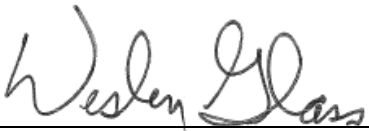

DIRECTOR
DIVISION OF MATERIALS

DATE

02/21/08

Kentucky Method 64-304-08
Revised 02/21/08
Supersedes KM 64-304-03
Dated 02/12/03

MAKING AND CURING CONCRETE STRENGTH (COMPRESSIVE)
TEST SPECIMENS IN THE FIELD

1. SCOPE: This method is a modification of ASTM C-31 covering procedures for making and curing compression test specimens in the field.
2. APPARATUS:
 - 2.1. Molds for Test Specimens:
 - 2.1.1. Reusable vertical metal molds shall be provided with a machined metal base plate. The inside dimensions of the cylinder mold shall be 4 inches in diameter by 8 inches in height (4x8's) or 6 inches in diameter by 12 inches in height (6x12's). The assembled mold shall not allow water to leak from the specimen and a suitable sealant shall be used if necessary to prevent leakage through the joints.
 - 2.1.2. Plastic, and sheet metal molds may be used provided they comply with the requirements of ASTM C-470. Molds that are damaged or out of round by more than 1/8 inch shall not be used. Certifications are required to be submitted by the manufacturer for each shipment stating the molds are made in accordance with ASTM C-470.
 - 2.2. Tamping Rod: The tamping rod for 6x12's shall be a round straight steel rod, 5/8 inch in diameter, 20 ± 4 " long with at least one end rounded to a hemispherical tip. The tamping rod for 4x8's shall be a round straight steel rod, 3/8 inch in diameter, 12 ± 4 " long with at least one end rounded to a hemispherical tip.
 - 2.3. Small Tools: Tools such as blunted shovels, scoops, pails, trowels, wood floats, straight edge, etc. shall be provided.
 - 2.4. Sampling and Mixing Container: A suitable pan, wheelbarrow, or flat, clean, non-absorbent mixing board of sufficient capacity to allow easy mixing by shovel or trowel of the entire sample shall be provided.
 - 2.5. Mold Coverings: Domed plastic lids.
 - 2.6. Vibrators: The vibrator frequency shall be at least 7000 vibrations per minute [150 Hz] while the vibrator is operating in the concrete. The diameter of a round vibrator shall be no more than one-fourth the diameter of the cylinder mold. Other shaped vibrators shall have a perimeter equivalent to the circumference of an appropriate round vibrator. The combined length of the vibrator shaft and vibrating element shall exceed the depth of the section being vibrated by at least 3 inches. The vibrator frequency shall be checked periodically.

3. SAMPLING CONCRETE:

- 3.1. Samples of concrete for test specimens shall be taken in accordance with Kentucky Method [64-301, Sampling Fresh Concrete](#). The sample shall be remixed the minimum amount necessary to insure uniformity.
- 3.2. Molding of specimens for strength tests shall be started within 15 minutes after the composite sample is taken.
- 3.3. Perform an air content, slump, and temperature test from the same sample of concrete from which cylinders are cast. Record the results on the SiteManager Sample Identification Form. Determine the air content, temperature and slump in accordance with the applicable Kentucky Methods.

4. PROCEDURE FOR MOLDING AND CURING SPECIMENS:

- 4.1. Place of Molding: Mold specimens promptly on a flat, rigid, horizontal surface, free from vibration and other disturbances and as near as practical to the place where they are to be stored during the first 24 hours.
- 4.2. Placing the Concrete: Place the concrete in the molds using a scoop, blunted trowel or shovel. Select each scoop from the mixing container in such a way as to insure that it is representative of the sample. It may be necessary to remix the sample in the container to prevent segregation during molding of the specimens. Discharge the concrete into the molds in such a way as to insure a symmetrical distribution of the concrete to minimize segregation within the mold. Further distribute the concrete by the use of the tamping rod prior to the start of consolidation.

Note: Cylinders for all classes of concrete are molded in sets of two for 6 inch diameter by 12 inch height cylinders (6x12's) and in sets of three for 4 inch diameter by 8 inch height cylinders (4x8's).

- 4.3. Method of Consolidation For 4x8's using Tamping Rod (Slump > 1 inch):
 - 4.3.1. Place the concrete in the mold in 2 layers of approximately equal volume. Rod each layer 25 strokes with the tamping rod, distributed evenly over the cross section of the mold, then tap the sides of the mold 10-15 times to close the voids before adding the next layer.
 - 4.3.2. Rod the bottom layer throughout its depth, however, do not strike the bottom of the molds so hard that dents or cracks are formed. Dents will cause a rough surface on the hardened specimen.
 - 4.3.3. Penetrate the rod about 1 inch into the underlying layer during rodding of the upper layer.
 - 4.3.4. Take special care in molding specimens of low slump concrete to insure that no voids remain in the completed specimen and that the mold is not damaged during

the molding process.

- 4.3.5. Strike off the surface of the concrete without undue manipulation with a straight edge, wood float, or trowel and immediately cover the specimen with a domed plastic lid.
- 4.4. Method of Consolidation For 6x12's using Tamping Rod (Slump > 1 inch):
 - 4.4.1. Place the concrete in the mold in 3 layers of approximately equal volume. Rod each layer 25 strokes with the tamping rod, distributed evenly over the cross section of the mold, then tap the sides of the mold 10-15 times to close the voids before adding the next layer.
 - 4.4.2. Rod the bottom layer throughout its depth, however, do not strike the bottom of molds so hard that dents or cracks are formed. Dents will cause a rough surface on the hardened specimen.
 - 4.4.3. Penetrate the rod about 1 inch into the underlying layer during rodding of the upper layers.
 - 4.4.4. Take special care in molding specimens of low slump concrete to insure that no voids remain in the completed specimen and that the mold is not damaged during the molding process.
 - 4.4.5. Strike off the surface of the concrete without undue manipulation with the straight edge, wood float, or trowel and immediately cover the specimen with a domed plastic lid.
 - 4.5. Method of Consolidation For 4 x 8's and 6 x 12's using Vibrator:
 - 4.5.1. Concrete with a slump \geq 1 inch consolidation may be done either by rodding or by vibration. Concrete with a slump < 1 inch shall be consolidated by vibration only.
 - 4.5.2. Place the concrete in the mold and fill to one-half depth of specimen.
 - 4.5.3. Start the vibrator and then insert vibrator throughout the depth. [(4 x 8's – 1 insertion) (6 x 12's – 2 insertions)] Do not over vibrate. Usually sufficient vibration has been applied as soon as the surface of the concrete has become relatively smooth and large air bubbles cease to break through the top surface. Continue vibration only long enough to achieve proper consolidation. Generally, no more than 5 seconds of vibration should be required for each insertion to adequately consolidate concrete with a slump greater than 3 inches. Longer times may be required for lower slump concrete, but the vibration time should rarely have to exceed 10 seconds per insertion. Slowly withdraw the vibrator so that no large air pockets are left in the specimen.
 - 4.5.4. Place the final lift in the mold, avoid overfilling by more than ¼ inch. Repeat vibration.

4.6. Curing Test Specimens:

4.6.1 Covering After Finishing: Cover the specimens immediately after finishing with a domed plastic lid to prevent evaporation of water from the concrete.

4.6.2. Initial Curing 6x12's and 4x8's:

4.6.2.1. Specimens made to check the adequacy of the mix design: During the first 24 ± 4 hours, store all test specimens under conditions that maintain the temperature immediately adjacent to the specimens in the range of 60°F to 90°F, and prevent loss of moisture from the specimens. Storage temperatures may be regulated by the means outlined in ASTM C31.

4.6.2.2. Specimens made from Class 'M', JPCP 24/48/72, Latex Modified Concrete, Low Slump Overlay Concrete or specimens made to determine falsework/form removal time or when a structure or pavement may be put into service: During the first 24 ± 4 hours, store the test specimens under conditions that represents the curing of the structure or pavement as much as possible and prevent loss of moisture from the specimens by using domed plastic lids. The specimens shall receive, insofar as practical, the same protection from the elements as is given to the concrete that they represent. This can usually be accomplished by placing the specimens under the curing blankets, wet burlap, or whatever is being used to cure the concrete. When the specimens cannot be placed under the curing blanket or wet burlap, the specimens may be stored in curing boxes maintained at the same temperature as the in place product. Temperature measuring devices are required to document temperatures at both locations.

4.6.3. Final Curing:

4.6.3.1. Specimens Made to Check the Adequacy of the Mix Design. - Regular Concrete and Low Slump Overlay Concrete: Remove the specimens from the mold at the end of 24 ± 4 hours and store in a moist condition at 60°F. to 80°F with free water maintained on all surfaces of the cylinder until time of shipment for testing. Do not expose specimens to dripping or running water. If storage in water is utilized, a saturated lime solution shall be used. (Approximately 7 grams of hydrated lime per gallon of storage water is sufficient to obtain a saturated solution). Bi-weekly tank temperature documentation is required for each tank. This documentation should include the date, time, temperature, and technician.

4.6.3.2. Latex Modified Concrete: Remove the specimens from the molds at the end of 24 ± 4 hours and then air cure at a temperature of 55°F to 85°F, until time of shipment for testing. Latex modified concrete

cylinders shall be tested in the air-cured condition.

- 4.6.3.3. Specimens made from Class 'M', JPCP 24/48/72 or specimens made for determining falsework/form removal time or when a structure or pavement may be put into service: Leave the specimens covered in the molds and store in or on the structure. The specimens shall receive, insofar as practical, the same protection from the elements as is given the portions of the structure which they represent until time of shipment for testing. This may be accomplished by placing the specimens under the same curing blankets or wet burlap used for curing the concrete. Specimens that represent pavement may be placed at the edge of the pavement under the curing blanket or wet burlap with soil or aggregate placed around the specimens. When the specimens cannot be placed under the curing blanket or wet burlap, the specimens may be stored in unheated curing boxes made of wood or styrofoam. Specimens shall not be directly exposed to the elements anytime during the time the structure is being cured. When curing of the concrete is discontinued and the specimens are not yet tested, the specimens shall be uncovered and removed from the molds for the remaining amount of time until sent to the Lab for testing.

5. PROCEDURE FOR IDENTIFYING SPECIMENS:

- 5.1. Mark the specimens to positively identify them and the concrete they represent. Use a method that will not alter the top surface of the concrete. Do not mark the removable caps. Upon removal of the molds, mark the test specimens to retain their identities.
- 5.2. The identification procedure shall be as follows:
 - 5.2.1. Non QC/QA Projects: Structure # - Date – Letter representing the sequence of units*.

* The sequence of units is based on the testing frequency for that class of concrete. For example: if 150 cubic yards of class AA concrete are poured contiguously on a single day, the cylinders representing the first 50 cubic yards would be designated by the letter "A", the cylinders representing the second 50 cubic yards would be designated by the letter "B", etc. If a set of cylinders are made for early breaks, the unit identification should be replaced with an "X".
- 5.3. Independent Assurance (Progress Record Sample) specimens shall be identified the same as job control specimens except the letter R shall be added after the letter designating the number of daily units.

6. SHIPPING SPECIMENS FOR TESTS:

- 6.1. Ship all specimens, insofar as practical, in suitable containers or in damp sand or sawdust so as to prevent either damage, freezing, or loss of moisture.

- 6.2. If testing is to be performed by the Central Laboratory, cylinders made to check the adequacy of the mix design should be shipped at the age of 21 days. (This does not apply to mixes that require strength before 28 days.)

APPROVED

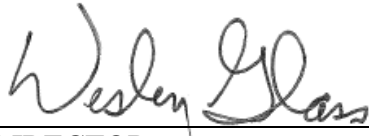

DIRECTOR
DIVISION OF MATERIALS

DATE

03/07/08

Kentucky Method 64-305-08
Revised 03/07/08
Supersedes KM 64-305-06
Dated 03/03/06

TEST FOR FREE MOISTURE CONTENT OF CONCRETE AGGREGATES

1. SCOPE: This method provides four optional methods for determining the free moisture content of fine and coarse aggregate to be used in concrete.
2. SAMPLING: The sample shall be taken in a manner which will be representative of the moisture condition of the aggregates, from portions of stockpiles proposed for immediate use and in an amount sufficient for the method of test to be used.
3. METHOD 1: FINE AGGREGATE: Speedy Moisture Tester Method:
 - 3.1. This method is performed by the use of an apparatus commonly referred to as a "Speedy Moisture Tester". This apparatus is calibrated to indicate free moisture content from gas pressure resulting when free moisture on the aggregate reacts chemically with a known quantity of calcium carbide.
 - 3.2. The apparatus manufacturer's recommended procedures shall be used for determining moisture content by this method. As the operational instructions vary somewhat with different tester manufacturers it is necessary to follow the instructions as provided with the specific equipment in use.
 - 3.3. The dial of this apparatus is supposed to indicate the per cent of free moisture contained in the sample. However, it has been determined by laboratory tests that this type apparatus actually measures part of the aggregate's absorbed moisture. Therefore, to obtain a more accurate free moisture content, subtract 1/2 of the absorption percentage furnished by the District Laboratory from the dial reading. Never use the manufacturer's correction chart accompanying the apparatus.
 - 3.4. Always run at least two tests when using a six gram speedy moisture tester and use the average as the free moisture content.
4. METHOD 2: FINE OR COARSE AGGREGATE:
 - 4.1. Total Moisture Content Minus Absorption Method: This method is intended to provide a means of obtaining the free moisture content of either fine or coarse aggregate by use of the total moisture content in terms of the dry weight (oven-dry) and the absorption percentage as furnished by the District Laboratory.
 - 4.2. Apparatus:
 - 4.2.1. Balance: A balance or scale accurate to 0.1 percent of the weight of the sample to be tested.
 - 4.2.2. Heat Source: A source of heat such as an electric or gas hot plate, stove, oven, or

microwave oven.

4.2.3. Sample Container:

4.2.3.1. Sample Container for Electric or Gas Hot Plate, Stove, or Oven: A metal container not affected by the heat, of sufficient volume to contain the sample without danger of spilling, and of such shape that the least lateral dimension will not be less than five (5) times the depth of sample.

4.2.3.2. Sample Container for Microwave Oven: A non-metallic container made of special thermal shock resistant material and of sufficient volume to contain the sample without any danger of spilling while being stirred.

4.2.4. Sample: The size of sample shall be in accordance with [table 1](#).

4.3. Procedure:

4.3.1. Procedure for electric or gas hot plate, stove, or oven.

4.3.1.1. Weigh the sample to the nearest 1.0 gram, avoiding the loss of moisture to the extent possible.

4.3.1.2. Dry the sample thoroughly in the sample container, exercising care to avoid loss of any particles. With any heat source, other than a controlled temperature oven, stir the sample during drying to accelerate drying and avoid localized overheating. The sample is thoroughly dry when further heating causes, or would cause, less than 0.1 percent additional loss in weight.

4.3.1.3. Weigh the dried sample to the nearest 1.0 gram.

4.3.2. Procedure for microwave oven.

4.3.2.1. Weigh the sample to the nearest 1.0 gram, avoiding the loss of moisture to the extent possible.

4.3.2.2. Place the sample in the oven and dry for 3 minutes. (Observe the sample carefully during the first minute of heating to determine if any particles start to turn red hot. If so, turn off the oven immediately, discard this sample, and start the test over with another sample.) At the end of 3 minutes of drying, stir the sample thoroughly. Dry the sample 3 additional minutes, stir again, and then weigh to the nearest gram. Repeat the 3 minute drying periods until further heating causes less than 0.1 percent additional loss in weight.

4.4. Calculations:

4.4.1. Calculate the free moisture content as follows:

$$P = \frac{W - [D(I + A)]}{D(I + A)} \times 100$$

Where :

P = Free moisture content of sample in percent

W = weight of original sample in grams

D = weight of dried sample in grams

A = the decimal equivalent of the absorption percent as provided by the District Laboratory

Alternative Method:

$$P = \left[\left(\frac{W - D}{D} \right) \times 100 \right] - ABS$$

Where:

P = Free moisture content of sample in percent

W = weight of original sample in grams

D = weight of dried sample in grams

ABS = percent of absorption

5. METHOD 3: FINE AGGREGATE: Integrated Moisture Control Systems (Moisture Probe and Compensator)

- 5.1. The manufacturer's recommended procedures shall be followed for the installation and operation of the equipment.
- 5.2. The moisture apparatus shall be calibrated when installed, replaced, or repaired and once every three months thereafter by using [Method 2](#) above.
- 5.3. The calibration of the moisture apparatus shall be within $\pm 0.2\%$ of the free moisture as determined by Method 2.

6. METHOD 4: COARSE AGGREGATE:

- 6.1. Saturated-Surface Dry Condition Method: This method may be used to determine free moisture content of coarse aggregates directly from the loss in weight of a damp sample when it is dried to a saturated-surface dry condition by use of a towel. (This method is NOT applicable for determining the moisture condition of slag or aggregates which have less than zero free moisture i.e. have less absorbed moisture in them than they are capable of absorbing).
- 6.2. Apparatus:

6.2.1. Balance: The balance or scale shall be accurate to within 0.1 percent of the weight of the sample to be tested.

6.2.2. Sample Container: A metal container of sufficient volume to contain the sample without danger of spilling and of such shape that the least lateral dimensions will not be less than five (5) times the depth of the sample.

6.2.3. Towel: A towel or absorbent cloth of sufficient size to dry to sample to saturated-surface dry condition.

6.3. Sample: The size of the sample shall be in accordance with [Table 1](#).

6.4. Procedure:

6.4.1. Weigh the original sample to the nearest 1.0 gram avoiding the loss of moisture to the extent possible.

6.4.2. Using a towel, wipe the surface moisture from the sample until it is a saturated-surface dry condition taking care to avoid loss of any of the sample by spilling or from particles clinging to the towel. A sample is defined as being in a saturated-surface dry condition when all aggregate particles have the dark appearance resulting from the absorbed water and no individual particles within the sample contain visible surface moisture. Surface moisture on an aggregate particle will give it a sheen or glossy appearance.

6.4.3. Immediately weigh the saturated-surface dry sample to the nearest 1.0 gram.

6.5. Calculate the free moisture content as follows:

$$P = \frac{W - W_{ssd}}{W_{ssd}} \times 100$$

Where:

P = free moisture content of sample in percent

W = weight of original sample.

W_{ssd} = Weight of the saturated-surface dry sample.

TABLE 1

Designated Size of Aggregate	Minimum Weight of Test Portion, in Grams
Concrete Sand	1000
No. 78 or 9M	1000
No. 67 or No. 68	1500
No. 57 or No. 357	2000

APPROVED 

DIRECTOR
DIVISION OF MATERIALS

DATE 02/22/08

Kentucky Method 64-306-08
Revised 02/22/08
Supersedes KM 64-306-06
Dated 03/06/06

METHOD OF MEASURING LENGTH OF DRILLED CORES

1. SCOPE: This method covers the procedure for determining the length of a core drilled from portland cement or bituminous concrete pavement, or a portland cement concrete structure.
2. APPARATUS: The apparatus shall be a calipering device that will measure the length of axial elements of the core, and shall be marked with clear, definite, accurately spaced graduations. The spacing of the graduations shall be 0.1 in. or a decimal part thereof.
3. TEST SPECIMENS: Cores used as specimens for length measurement shall be representative of the pavement or structure from which they are obtained. The specimen shall be drilled with the axis normal to the surface of the pavement or structure and the ends shall be free from all conditions not typical of the surfaces of the pavement or structure. Cores that show abnormal defects or that have been damaged appreciably in the drilling operation shall not be used.
4. PROCEDURE: Each measurement shall be read directly to 0.05 in. either directly or by estimation. Make the initial measurement at the center of the core.
 - 4.1. Bituminous Concrete Pavement Cores: If the initial measurement is within ± 0.3 inch or beyond ± 0.7 inch of design thickness, no additional measurements are required. If the initial measurement is beyond ± 0.3 inch but within ± 0.7 inch of design thickness, take four additional measurements at equal intervals around the circumference of the core. (See Example 1)
 - 4.2. Portland Cement Concrete Pavement Cores: If the initial measurement is equal to or greater than the design thickness no additional measurements are required. If the initial measurement is less than design thickness, take four additional measurements at equal intervals around the circumference of the core.
 - 4.3. Portland Cement Concrete Structure Cores: Take four additional measurements at equal intervals around the circumference of the core.
5. REPORT: When 5 measurements are taken, the individual measurements shall be recorded to the nearest 0.05 in. and the average of the five measurements expressed to the nearest 0.1 in. shall be reported as the length of the core. When only one measurement is taken, it shall be recorded to the nearest 0.05 inch and reported to the nearest 0.1 inch. The even number rule will be used for rounding off measurements in all cases.

EXAMPLE 1

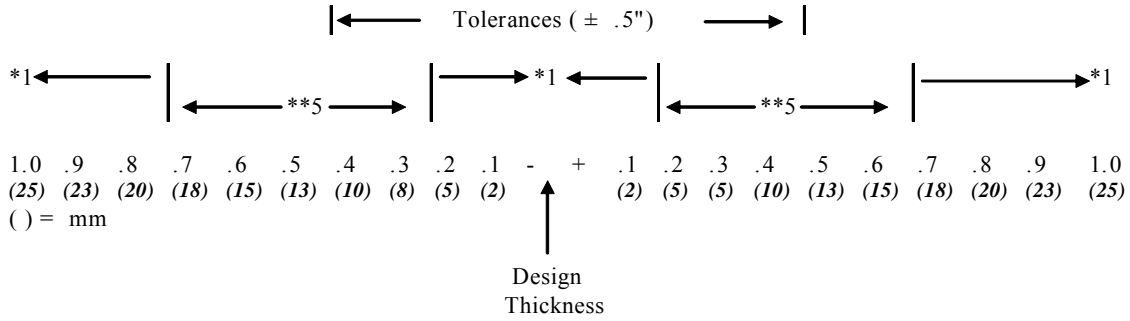

THIS GRAPH SHOWS TOTAL NUMBER OF THICKNESS MASUREMENTS
 REQUIRED FOR BITUMINOUS PAVEMENT CORES. REFER TO SECTION 4.1

- * Number of measurements required is one.
- ** Number of measurements required is five.

APPROVED Wesley Glass
 DIRECTOR
 DIVISION OF MATERIALS

DATE 02/22/08

Kentucky Method 64-308-08
 Revised 02/22/08
 Supersedes KM 64-308-03
 Dated 02/14/03

CORING RIGID PAVEMENT FOR THICKNESS

1. SCOPE: This method covers the procedure for obtaining and measuring drilled cores from rigid pavements for determining conformity with specified thickness. (NOTE: Cores are not required for projects involving less than 2500 square yards of concrete pavement. Thickness acceptance may be on the basis of inspection of the contractor's application rate and visual inspection of placement.)
2. APPARATUS:
 - 2.1. Core Drill: A core drill of either shot drill or diamond drill type capable of drilling a 4 inch diameter core.
 - 2.2. Calipering Device: A calipering device conforming to [Kentucky Method 64-308](#), Method of Measuring Length of Drilled Cores.
3. CORE SPECIMENS: Cores shall conform to Kentucky Method 64-308, and shall have a nominal diameter of not less than 4 inches.
4. MEASUREMENT OF CORES: Cores shall be measured in accordance with Kentucky Method 64-308.
5. PROCEDURE FOR OBTAINING CORES AND DETERMINING CONFORMITY WITH SPECIFIED THICKNESS:
 - 5.1. Units to be considered separately for coring are defined as 1000 lineal feet of the poured pavement width starting at the end of the pavement bearing the smaller station number, except small irregular areas such as crossovers, entrances, etc., may be grouped as separate units comprising not more than 1000 square yards each. For turning lanes, units shall be considered as 800 to 1200 lineal feet of pavement, including tapers, and may include more than one (1) turning lane. For shoulder pavement, units shall be of the lengths given in the table in Section 5.1.3. One random core shall be taken from each defined unit. To best represent each unit, the original cores shall be taken at various distances from centerline and on alternate sides of the paved width centerline. The unit will be considered in conformance with specifications if 1) any core taken from mainline, ramps, turning lanes, crossovers, or entrance pavement is not deficient by more than 0.20 inch from plan thickness, or 2) any core taken from shoulder pavement is not deficient by more than 0.30 inch from plan thickness.
 - 5.1.1. The last unit in each poured pavement width may represent as much as 1500 lineal feet).
 - 5.1.2. Ramps and ramp stubs will be cored as a single poured pavement width except ramp stubs when poured as part of another contract will be cored separately.

5.1.3. Coring Frequency for Various Shoulder Widths:

If Shoulder Width Is	Coring Frequency Is	Exploratory Coring Frequency is
4'	3000'	900'
6'	2000'	600'
8'	1500'	500'
10'	1200'	400'
12'	1000'	300'

5.2. Cores Deficient from 0.21 to 1.00 inch - When any core is found to be deficient from plan thickness by 0.21 inch to 1.00 inch inclusive, additional cores will be taken and an average thickness determined for the affected unit as follows:

5.2.1. On dual lane constructed pavement, 2 additional cores shall be taken at intervals of not less than 300 feet within the unit and within the lane from which the original core was obtained. Additionally one core shall be taken in the adjacent lane across from the original deficient core.

5.2.2. On single lane constructed pavement 2 additional core shall be taken at intervals of not less than 300 feet within the unit.

5.2.3. On small irregular areas 2 additional cores shall be taken from the unit and at random locations as determined to best represent the unit.

5.2.4. The reported thickness of a unit shall be the average thickness determined from all cores obtained within the unit expressed to the nearest 0.10 inch except as follows: Cores measuring more than 0.20 inch in excess of plan thickness will be considered as being plan thickness plus 0.20 inch for purposes of computing the unit average. Cores found to be deficient from plan thickness by more than 1.00 inch shall not be used in determining average thickness of units but shall require the drilling of additional cores as required in Section 5.4.

5.2.5. Units from mainline, ramps, crossovers or entrance pavement determined to have average thickness not deficient by more than 0.20 inch or units from shoulder pavement determined to have average thickness not deficient by more than 0.30 inch will be considered in conformity with specifications. Units determined to have average thickness outside of these ranges will be subject to a reduced price in accordance with Section 501.05.01 of the current [Standard Specification](#).

5.3. Shoulder Cores Deficient from 0.31 inch to 1.00 inch - When any shoulder core is found to be deficient from plan thickness by 0.31 inch to 1.00 inch inclusive, 2 additional cores will be taken and an average thickness determined for the affected unit. Refer to [Section 5.1.3](#) for taking additional cores.

- 5.4. Cores Deficient More than 1.00 Inch - When the measurement of any core is deficient from plan thickness by more than 1.00 Inch the extent of 1.00 Inch deficient area will be determined by taking additional cores at not less than 10 foot intervals parallel to the centerline in each direction from the deficient core until in each direction a core is obtained which is not deficient by more than 1.00 Inch. (For small, irregular areas additional cores will be taken at not less than 10 foot intervals and in a manner considered to best determine extent of the deficient area.)
6. REPORT: The report shall document the measured length of all cores and the location of all cores with respect to project stationing and the centerline of pavement. Additionally, station references or other descriptions shall be documented to establish location and extent of areas deficient by more than 1.00 inch or areas subject to price reduction. The average thickness for each unit subject to averaging shall be reported.

APPROVED

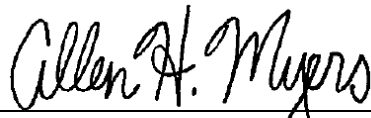

DIRECTOR
DIVISION OF MATERIALS

DATE

10/11/17

Kentucky Method 64-309-17
Revised 10/11/17
Supersedes KM 64-309-08
Dated 02/22/08

CONCRETE "TRUCK MIXER" INSPECTION PROCEDURE

1. SCOPE:
 - 1.1. This method is a procedure for performing the approval inspection of portland cement concrete truck mixers. The procedure shall apply to all truck mixers (ready mix trucks) used for mixing concrete on Department projects.
 - 1.2. Trucks which deliver central mixed concrete to which water is not added at the jobsite will be exempt from this test.
 - 1.3. Continuous mobile mixers will be checked by [KM 64-312](#).
2. APPARATUS:
 - 2.1. [Specification Book](#): Truck mixer requirements are listed in Section 601.02.16.
 - 2.2. Slump Cone: A mold as described in [Kentucky Method 64-302](#) to measure the slump of the fresh concrete.
 - 2.3. Miscellaneous Equipment: Sufficient tamping rods, strike-off bars and ruler or tape to complete the slump test. Mirror(s) or flashlight to visually inspect the interior of the mixer drums.
3. INSPECTION ITEMS:
 - 3.1. Inspection for Accumulation of Hardened Concrete in Mixer Drums
(See Figure 1 for Mixer Blade Types.)
 - 3.1.1. Procedure: A flashlight or mirror shall be used to give the interior of the mixer drums a thorough visual examination to detect the presence of an accumulation of hardened concrete or mortar.
 - 3.1.2. Requirement: The interior of the mixer drums and loading and discharge chutes, shall be maintained free from hardened concrete. Free from hardened concrete is defined as follows:
 - 3.1.2.1. The chutes and upper half of each blade shall, by visual inspection, be essentially free of hardened concrete or mortar (not more than 5% of the surface area shall be coated).
 - 3.1.2.2. The lower half of each blade shall, by visual inspection, not have a build-up of hardened concrete or mortar that extends more than 25% of the blade height.

3.1.2.3. The total accumulation of hardened concrete or mortar on all surfaces within the drum shall, by visual inspection, be less than two cubic feet.

3.2. Test for Concrete Consistency:

3.2.1. Procedure: Obtain two samples of concrete from a mixer batch as the mixer is discharging at its normal operating rate. Sampling will be as prescribed in [KM 64-301](#), except the samples will be taken as follows: One sample shall be obtained when the discharge of the batch is approximately 15% complete and the second sample shall be obtained when the discharge is approximately 85% complete. Not more than 15 minutes shall elapse between obtaining the two samples. Perform slump tests on each sample in accordance with [KM 64-302](#).

3.2.2. Requirements:

3.2.2.1. The slump for each of the two samples shall not vary more than 1 inch.

3.3. Inspection for Presence of Metal Plate:

3.3.1. Procedure: Perform visual inspection to verify presence of plate and that plate contains the required information.

3.3.2. Requirement: Each truck mixer shall have a metal plate attached on which is stated the manufacturer's capacities in terms of volume of mixed concrete for the various uses to which the equipment is applicable and the manufacturer's stated speeds of rotation for mixing and agitation.

3.4. Inspection of Automatic Revolution Counter:

3.4.1. Procedure: The operation of the revolution counter shall be verified by observing the increase in revolutions on the counter as the drum is turning.

3.4.2. Requirement: The truck mixer shall be equipped with an automatic revolution counter which will permit reading of the count at the plant and at the destination.

3.5. Inspection of Device for Measuring Water Added at the Job Site:

3.5.1. Procedure: The trucks shall be visually checked for the presence of a standpipe and graduated scale (or other approved device). The scale and standpipe shall be maintained free of any substance that would hinder the measurement readings.

3.5.2. Requirement: The tanks containing mixing water on truck mixers shall be equipped with a device for accurately determining the quantity of water added at the job site.

4. FREQUENCIES:

- 4.1. Hardened Concrete in Mixer Drums: Prior to approval of truck and at least monthly thereafter during production or at any time deemed necessary.
- 4.2. Concrete Consistency: A consistency test will be made on each truck mixer as soon as possible after the first delivery to the project but no later than the third delivery. Thereafter, a consistency test shall be performed every 12 months or at any time the Project Engineer or his representative suspects nonuniformity of the concrete.
- 4.3. Metal Plates: Prior to approval of truck and thereafter each day the truck is being used for Department work.
- 4.4. Revolution Counter - Prior to approval of truck, and thereafter each day the truck is being used for Department work.
- 4.5. Water Tank Measuring Device - Prior to approval of truck, and thereafter each day the truck is being used for Department work.

5. COMPLIANCE:

- 5.1. An approval sticker/sheet shall be kept in each truck mixer which fully complies with the requirements contained in sections 3.1 thru 3.5. Any time an inspection reveals that a truck with an approval sticker/sheet does not conform to all requirements contained in sections 3.1 thru 3.5, the sticker/sheet shall be marked void, dated, and initialed and its use on the Department project shall be discontinued until repair, replacement, cleaning, or modification are proven adequate by retest or examination.
- 5.2. Approval sticker/sheets may be obtained from the Division of Construction.

APPROVED

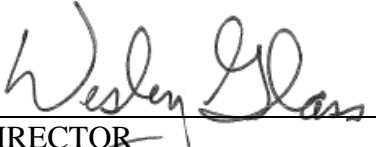

DIRECTOR
DIVISION OF MATERIALS

DATE

02/22/08

Kentucky Method 64-311-08
Revised 02/22/08
Supersedes KM 64-311-05
Dated 01/04/05

Attachment

KENTUCKY TRANSPORTATION CABINET
Department of Highways
DIVISION OF CONSTRUCTION

TC 63-55
Rev. 4/87

CONCRETE MIXER
PERFORMANCE AND CONDITION APPROVAL

SLUMP DEVIATION SATISFACTORY ___ YES ___ NO
METAL PLATE FOR DRUM SPEEDS ___ YES ___ NO
AUTOMATIC REV. COUNTER ___ YES ___ NO
WATER MEASURING DEVICE ___ YES ___ NO
MIXER DRUM FREE OF CONCRETE ___ YES ___ NO

DATE APPROVED _____ BY _____

THIS APPROVAL EXPIRES 1 YEAR FROM THIS DATE

TRUCK NUMBER _____

CONCRETE PRODUCER NAME _____

MIXER DRUM INSPECTED FOR HARDENED CONCRETE

DATE	INITIAL	DATE	INITIAL
JAN _____	_____	JULY _____	_____
FEB _____	_____	AUG _____	_____
MAR _____	_____	SEPT _____	_____
APR _____	_____	OCT _____	_____
MAY _____	_____	NOV _____	_____
JUNE _____	_____	DEC _____	_____

Kentucky Method 64-312-08
Revised 02/22/08
Supersedes KM 64-312-04
Dated 06/10/04

**CALIBRATION OF CONTINUOUS - TYPE MIXERS
(CONCRETE MOBILES)**

1. **SCOPE:** This method covers the calibration of continuous type mixers (concrete mobiles) used in producing latex concrete and low slump concrete for bridge deck overlays and Class A or B concrete. It also includes a procedure for checking and adjusting the yield of the actual concrete mix. (ASTM C 685 may be used instead of this method)
2. **APPARATUS:**
 - 2.1. **Basic Apparatus**
 - 2.1.1. Operating manual for truck being calibrated.
 - 2.1.2. Accurate stop watch - readable to 0.1 seconds.
 - 2.1.3. Accurate scales (platform or hanger type) readable to ½ lb.) with a minimum capacity of 200 lbs.
 - 2.1.4. One clean 20 gallon container.
 - 2.2. Additional Apparatus for low slump Concrete only: Thirty-two fluid ounce measuring cup.
 - 2.3. Additional Apparatus for Latex Concrete Only: Another clean 20 gallon container.
 - 2.4. Quick Yield Apparatus: A strong rigid box that will hold exactly ¼ cubic yard 36" x 36" x 9".
3. **PRE-CALIBRATION INSPECTION:** (To be performed by the concrete mobile operator in the presence of the inspector)
 - 3.1. Both aggregate bins should be empty and thoroughly cleaned.
 - 3.2. The main conveyor belt should be thoroughly cleaned, including the chain.
 - 3.3. Make sure that all bin vibrators are functioning properly. Check by "feel" of hand against the side of the bin to the vibrator.
 - 3.4. The cement meter-feeder wheel should be thoroughly cleaned.
 - 3.5. Check spring tines to make sure they are properly tensioned on cement meter-feeder.

- 3.6. Be certain that all "fingers" on cross-auger in cement bin are in place and straight.
- 3.7. Make sure the cement bin aeration system is functioning properly. The control valve should be depressed for about 10 seconds to fluff the cement in the bin prior to the calibration and prior to concrete production at the jobsite.
- 3.8. Make sure that the connections at both ends of the drive cable connecting the meter register and the cement feeder shaft are tight and that the cable is free of kinks.
- 3.9. Make sure that the concrete mobile is properly grounded. A build up of static electricity may prevent normal flow of the cement.
- 3.10. Make sure that the cement bin breather hole is open to free atmospheric pressure.
- 3.11. Put at least 36 bags (3384 lbs) of cement in the cement bin.

4. CEMENT CALIBRATION:

- 4.1. For units having a tachometer, the throttle shall be set to hold the specified tachometer reading (± 50 rpm under load). The correct tachometer reading is specified on the title page of the operating manual for each concrete mobile.
- 4.2. Set the cement meter register so it reads zero.
- 4.3. Obtain a tare weight or balance off the weight of a dry, clean container and place it under the swivel ring so that it will catch all of the cement discharge.
- 4.4. Engage the main clutch to make the concrete-mobile operative and precisely at the same time, start the stopwatch.

NOTE: The cement meter count for this check shall be whatever is required to discharge approximately 94 lbs. of cement.

- 4.5. Watch the cement meter register and when it registers the predetermined count, immediately disengage the main clutch and stop the watch simultaneously. Weigh the container and record the net weight of cement, the elapsed time, and the meter count on form [TC 64-317](#).
- 4.6. Repeat steps 4.2, 4.3, 4.4 and 4.5 at least four additional times.
- 4.7. Based on the five "runs" calculate the "cement meter count" and "discharge time" for 94 lbs. (1 bag) of cement.

EXAMPLE:

Summation of lbs. = 93 + 94 + 94 + 95 + 94 = 470 lbs.

Summation of Meter Counts = 67 + 69 + 68 + 69 + 68 = 341 counts

Summation of Seconds = 28.2 + 28.2 + 28.1 + 28.2 + -28.3 = 141.0

$$Lbs / count = \frac{Total Lbs}{Total Count} = \frac{470}{341} = 1.38lbs / count$$

$$Lbs / second = \frac{Total Lbs}{Total Seconds} = \frac{470}{141.0} = 3.33lbs / second$$

$$Cement Meter Count for 94lbs. of Cement = \frac{94lbs./count}{1.38 lbs./count} = 68.0 counts$$

$$Discharge Time for 94 lbs. cement = \frac{94 lbs.}{3.33 lbs./sec.} = 28.2 sec.s.$$

5. SAND CALIBRATION:

- 5.1. Add at least one or two tons (be sure the bottom of the bin is covered) of sand which is to be used on the project. The stone bin must be empty while calibrating the sand gate.
- 5.2. Be sure the concrete mobile is operating at the specified operating speed (check the tachometer). Be sure the sand bin vibrators are operational.
- 5.3. Obtain the tare weight (or balance off the weight on the scale) of the container which is to be used to catch the sand.
- 5.4. Select some gate setting for a starting point. The sand discharge shall be checked at gate openings that will deliver, 1) an amount less than the computed damp weight per bag, 2) an amount approximately equal to the computed damp weight per bag, 3) an amount greater than the computer damp weight per bag. This will require checking the sand discharge at a minimum of three gate opening and possibly more.

NOTE: Approximately damp weights of sand per bag of cement for the various concrete mixes are as follows:

Latex Concrete Overlay Mix - 230 ± 15 lbs.).

Low Slump Concrete Overlay Mix – 160 ± 5 lbs.

Class A Concrete Mix - 210 ± 10 lbs.

Class B Concrete Mix - 300 ± 10 lbs.

- 5.5. Charge the belt with sand by allowing at least five linear feet of the loaded belt to discharge on the ground.

- 5.6. Position the container under the discharge so that it will catch all of the material. Engage the main conveyor control and allow to operate for exactly one-half of the discharge time determined in step 4.7 (1/2 of 28.2 seconds = 14.1 seconds for this example). Weigh the container and record the net weight of sand. Repeat the process again and record the net weight of sand. The weights of sand for the two trials should be within 5 lbs. of each other; if not, continue the procedure until two consecutive trials are within 5 lbs. The sum of the two acceptable consecutive trials is recorded on the form [TC 64-317](#) along with that particular gate setting.
- 5.7. Based on the results obtained in step 5.6 select at least two additional gate settings to fulfill the requirements set forth in step 5.4.

EXAMPLE: Assume that you are calibrating for a low slump concrete overlay mix and that a gate setting of 3.0 discharged 79 and 77 lbs. during the two discharge times of 14.1 seconds. This results in a total of 156 lbs. which will probably be reasonably close to the actual damp weights per bag for this mix. Now the objective is to select a gate setting that will discharge about 20 to 40 lbs. more than the actual damp weights (try 3.3) and a gate setting that will discharge about to 40 lbs. less than the actual damp weights (try 2.7).

- 5.8. Accurately plot on a sheet of graph paper the gate settings versus the lbs. of sand discharged. Determine from the plot the gate setting which will supply the computed damp weight of sand and adjust the pointer on the sand gate accordingly. (See example # 1).

6. STONE CALIBRATION:

- 6.1. Add at least one or two tons (be sure the bottom of the bin is covered) of stone which is to be used on the project. The sand bin must be empty while calibrating the stone gate.
- 6.2. Follow the same procedure as for calibrating the sand discharge.

NOTE: Approximate damp weights of stone per bag for the various concrete mixes are as follows:

Latex Concrete Overlay Mix 180 ± 15 lbs.

Low Slump Concrete Overlay Mix – 160 ± 5 lbs.

Class A Concrete Mix - 300 ± 10 lbs.

Class B Concrete Mix – 390 ± 10 lbs.

7. WATER CALIBRATION:

- 7.1. Calibration of the flow meter or control valve:
 - 7.1.1. It is possible to perform this test on mechanical units by opening the quick-acting water valve, and the cement and aggregate bins can remain loaded. On hydraulic units the aggregate bins must be empty.
 - 7.1.2. Obtain the tare weight of the container.
 - 7.1.3. Concrete mobile units are equipped with either a water flow meter graduated to

indicate gallons per minute or a water control valve. Preset the water flow meter or the water control valve at some setting as a starting point.

- 7.1.4. Position the container so that it will catch all of the water discharge.
- 7.1.5. Open the quick-acting valve (mechanical units) manually and start the stopwatch at the same time. On hydraulic units engage the main conveyor and start the stopwatch at the same time. Observe the stopwatch and close the water valve or disengage the main conveyor when the discharge time as determined in step 4.7 has elapsed.
- 7.1.6. Weigh the container and record the net weight of water and the setting on for [TC64-317](#).
- 7.1.7. Repeat steps 7.1.4, 7.1.5, and 7.1.6 at enough additional settings to include a discharge range of from 10 to 35 lbs. of water in the running time as determined in [step 4.7](#).
- 7.1.8. Plot the weight of water discharged against the various settings on a sheet of graph paper.

7.2. Calibration of the Cumulative Water Meter:

- 7.2.1. Reset the cumulative water meter on zero and discharge 4 to 5 gallons into a container.
- 7.2.2. Determine the net weight of water and compare with the cumulative meter reading. The cumulative meter is required to be accurate within $\pm 1\%$.

8. LATEX CALIBRATION:

8.1. Calibration of the Latex Control Valve:

- 8.1.1. Assume that the latex weighs 8.4 lbs. per gallon unless the manufacturer's certification indicates the weight to be something greater.
- 8.1.2. Remove and clean the filter screen in the line between the latex tank and the pump.
- 8.1.3. Make sure the latex tank is vented before starting the pump. Then let the pump run for two minutes before calibrating.
- 8.1.4. Determine the control valve setting to discharge 3.5 gallons of latex during the discharge time determined in [step 4.7](#) ($8.4 \times 3.5 = 29.4$ lbs.) continue until two consecutive trials discharge 29.5 lbs. ± 5 lbs.

8.2. Calibration of the Cumulative Latex Meter:

- 8.2.1. Reset the cumulative latex meter to zero and discharge 4 to 5 gallons into a container.

- 8.2.2. Determine the net weight of latex and compare with the cumulative meter reading. The cumulative meter is required to be accurate within $\pm 1\%$.

9. TYPE A OR D AND AIR ENTRAINING ADMIXTURE DISPENSER CALIBRATION:

- 9.1. Concrete mobiles are usually equipped with a Hi-Flo dispenser for dispensing Type A or D admixtures and a Low-Flo dispenser for dispensing air entraining admixtures.
- 9.2. It is necessary to dilute both admixtures. Usually both admixtures are diluted by mixing 5 parts of water to 1 part of admixture; however; some contractors prefer to dilute the air entraining admixture at the rate of 3 parts of water to 1 part of admixture. The dilution and mixing shall be done before the solution is put into the tanks.
- 9.3. The process of diluting admixtures should be observed by the inspector. The dispensing system should be clean and free of admixture solutions from other job prior to adding anew admixture solution to the tanks.
- 9.4. Select various settings on the Hi-Flo dispenser that will include a discharge range of from 2 to 5 fluid ounces of actual undiluted Type A or D admixture in the discharge time determined in step 4.7. Select various settings on the Low-Flo dispenser that will include a discharge range of from 0.5 to 3 fluid ounces of the actual undiluted air entraining admixture in the discharge time determined in [step 4.7](#).
- 9.5. Select a setting to start with (read the top of the float) and position the measuring cup to catch the discharge. Activate the dispenser and start the stopwatch simultaneously and allow to run until the time as determined in step 4.7 has elapsed.
- 9.6. Continue this process at various settings to include the ranges listed in step 9.4. Record the dispenser settings and amount discharged on form [TC 64-317](#). Plot the amount discharged against the dispenser setting on a sheet of graph paper and use the graph to select the setting needed to supply the amount desired. (See example # 3).

EXAMPLE: Assume that you are calibrating the air entraining dispenser using a dilution ratio of 3 parts of water to one part of air entraining admixture. Since the desired range of actual admixture discharge is from 5 to 3 fluid ounces, the range of total solution discharge would be from 2 to 12 fluid ounces $((3 \times (.5)) + (1 \times (.5)) = 2$ fluid ounces and $(3 \times 3) + (1 \times 3) = 12$ fluid ounces. An initial setting of .3 showed a discharge of 2 1/2 fluid ounces, next a setting of .7 discharged 6 fluid ounces, next a setting of 1.0 discharged 8 fluid ounces, and finally a setting of 1.5 discharged 12 fluid ounces. The dispenser settings are plotted on graph paper against the total solution discharged for each setting.

10. YIELD CHECK AND MIX ADJUSTMENT: Quick Yield Procedure:

- 10.1. The initial yield check should be made with the proportioning controls set as determined during the calibration procedure. Also the slump and air content should be within the specification limits prior to performing the yield test.
- 10.2. Determine the cement meter count to produce 1/4 of a cubic yard of concrete. Do this by dividing the cement factor by 4 and multiply this figure times the meter count for one bag of

cement.

EXAMPLE: Using the cement meter count of 68 as determined in the [example in step 4.7](#), cement meter count for 1/4 cubic yard for the various mixes would be as follows:

$$\text{Latex Overlay Concrete Mix} = \frac{9.2 \text{ BAGS}}{4} \times 68 = 156$$

$$\text{Low Slump Overlay} = \frac{11.44 \text{ BAGS}}{4} \times 68 = 194$$

$$\text{Class A Concrete} = \frac{7.85 \text{ bags}}{4} \times 68 = 133$$

$$\text{Class B Concrete} = \frac{6.28 \text{ bag}}{4} \times 68 = 107$$

- 10.3. Stop the main conveyor belt but allow the mix conveyor (auger) to run until empty and then clean the chute.
- 10.4. Take a reading on the cement meter register.
- 10.5. Engage the main conveyor and the mix conveyor simultaneously. Allow the main conveyor to run until the cement meter register has advanced by the number of counts required (see example in step 10.1.2) to discharge 1/4 cubic yard of concrete and then shut it off quickly. Again, allow the mix conveyor (auger) to run until empty and clean chute. The mix should be consolidated as the box is filling with a shovel or other satisfactory tool, especially in the corners.
- 10.6. If the yield is not such to fill the box within plus or minus one quarter inch of level full, the sand and stone dial openings shall be adjusted by an amount deemed necessary to produce the correct yield. Another yield determination should be made shortly after making adjustments in the aggregate dial openings.
- 10.7. If the yield is such to not fill the box within plus or minus one inch level full, the operation should be stopped until some determination can be made as to the reason for the discrepancy.

APPROVED

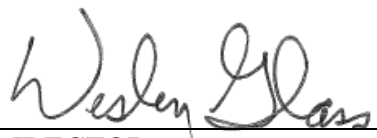

DIRECTOR
DIVISION OF MATERIALS

DATE

02/22/08

Kentucky Method 64-312-08

Revised 02/22/08

Supersedes KM 64-312-04

Dated 06/10/04

Attachment

KENTUCKY TRANSPORTATION CABINET
 DEPARTMENT OF HIGHWAYS
 DIVISION OF MATERIALS

TC 64-317
 Rev. 12/86

CONCRETE MOBILE CALIBRATION DATA SHEET

COUNTY _____ Project No. _____

CONTRACTOR _____ Date _____

TRUCK NO. _____ SERIAL NO. & CAPACITY _____

TRUCK R.P.M. _____ CALIBRATED BY _____

CEMENT

Lbs./count = $\frac{\text{Total Lbs.}}{\text{Total Counts}}$ = _____ = _____

Container Wt. _____		
LBS.	COUNT	SECS.
1		
2		
3		
4		
5		
TOTALS		

Lbs./sec. = $\frac{\text{Total Lbs.}}{\text{Total Secs.}}$ = _____ = _____

Counts for 94 Lbs. = $\frac{94}{\text{Lbs./Count}}$ = $\frac{94}{\text{Lbs./Count}}$ = _____

Sec. for 94 Lbs. = $\frac{94}{\text{Lbs./Sec.}}$ = $\frac{94}{\text{Lbs./Sec.}}$ = _____

SAND

Sec. for Calibration _____ Container Wt. _____ Moisture Content _____

Dial Setting

Lbs. of Sand

STONE

Sec. for Calibration _____ Container Wt. _____ Moisture Content _____

Dial Setting

Lbs. of Sand

AIR OR LATEX

Sec. for Calibration _____

Setting

Fl. Ozs. or Lbs.

TYPE "A" or TYPE "D" ADMIXTURE

Sec. for Calibration _____

Setting

Fl. Ozs.

WATER

Sec. for Calibration _____ Container Wt. _____

Setting

Lbs.

MEASUREMENT OF BRIDGE DECK REINFORCEMENT COVER

1. SCOPE:
 - 1.1. This method is a procedure for measuring the concrete cover over the top mat of steel reinforcement in bridge slabs. (NOTE: The contents of this method are the responsibility of the Division of Construction. The Division of Materials is responsible for printing and distribution of this method.)
 - 1.2. The method of determining the deduction to be applied to deficient or excessive cover is also shown.
2. APPARATUS:
 - 2.1. Pachometer: A magnetic probe attached to a meter that is capable of measuring the concrete cover on steel reinforcement. The device may be handheld or rolling.
 - 2.2. Miscellaneous Supplies: 100' tape and white spray paint.
 - 2.3. Structure Plans.
 - 2.4. Traffic Control Devices: Appropriate signs, cones, and flags.
 - 2.5. Sufficient personnel to operate the pachometer, take notes, and traffic control if the bridge is open to traffic.
3. PROCEDURE FOR LAYING OUT GRID SYSTEM ON DECK FOR PACHOMETER READINGS:
 - 3.1. The intent is to take the measurements on a slab grid system with points on 10-foot centers longitudinally and 5-foot centers laterally. When the slab length and width result in excess dimensions, then these excess dimensions are to be applied equally to both slab ends and both gutterlines. These grid points are marked on the slab. Spray paint should be used if the grid will be needed for an undetermined length of time.
 - 3.2. On skewed bridges the first grid point for each grid line should be the same distance from the end of the bridge. The 5 feet distance between longitudinal lines should be at right angles to center line of bridge.
 - 3.3. The overall length and width of the bridge slab shall be determined from plan dimensions. The slab width to be considered will extend from inside face of curb to inside face of curb. The slab length will be the "out-of-out" slab dimension indicated on the plans.

4. PACHOMETER OPERATING PROCEDURES: Attach the probe to the rod and cables to the meter. Turn the pachometer on after attaching the probe and pointed away from any metal objects. Clear the stored memory, select the right bar size and allow the pachometer to reset before performing any testing.
5. PROCEDURE FOR TAKING PACHOMETER READINGS:
 - 5.1. Check the design plans for size of the top reinforcement bars in the deck. (Some bridges may have skewed transverse steel and some short span bridges may have a horizontal top bar.) If the bridge has two different sizes of transverse bars, note both sizes.
 - 5.2. Prepare a chart or table for recording the pachometer readings or use the pachometer to store the readings. Align the probe perpendicular to the axis of the top-most reinforcement and move it at right angles to this alignment. Move the probe across the grid point until the depth of the top mat is measured and displayed on the pachometer. Once the bar is located the pachometer will beep and display the bar depth in the memo box in bottom right of the display. Record the depth observed for the size of reinforcement. Continue this procedure at all grid points until all readings are recorded.
 - 5.3. Occasionally dust and debris will accumulate on the magnetic probe, which will require cleaning of the probe. This accumulation will affect the zero adjustment, and the actual reading of the cover.
 - 5.4. Extremely low readings may indicate the presence of a foreign metallic substance (nail, tie wire, metal filings) on or near the slab surface. As foreign materials may be within the grooves of textured surfaces, the deck should be thoroughly cleaned to remove such materials as would affect the pachometer readings.
6. EVALUATION OF PACHOMETER READINGS:
 - 6.1. After all readings are recorded they should be reviewed while still on the jobsite. If all readings are within 0.25" of the specification tolerances then no further field action is required, and no deductions will be made. If recorded readings are not within 0.25" of the specification tolerances then mark a minimum of three bar locations on the bridge deck for removal of cores. Extremely long bridges or phased construction may dictate more cores. These bars should be among those already read and should represent marginal bar cover or cover outside of specification tolerances. After these bars are relocated their locations are marked with spray paint and the grid number painted close by. The spray mark should be no longer than 12" and as narrow as possible to accurately locate the bar. The contractor will have the option of accepting the deduction as calculated by the pachometer readings or request the bridge deck be cored. If the contractor request the bridge deck to be cored for verification all adjusted readings between 0.25" and 0.50" will be subject to deduction.
 - 6.2. The Division of Materials will be notified by the Central Office Construction Engineer that bar depth cores are required. The Division of Materials will take partial cores to determine actual top mat cover at the marked locations. These cores will generally extend down to the top steel and be broken off, showing an impression of the rebar. The Division of Materials will bring these cores to the Materials Central Laboratory and report to the appropriate Division of Construction representative concerning the measured bar depths.

These cores will be turned over to the Division of Construction and kept until final release of the project. The contractor is welcome to review the cores.

- 6.3. The Division of Construction representative will evaluate the core measured bar depths and make appropriate adjustments to the pachometer readings. If one set of cores is taken to represent deficient cover and another set for excessive cover, then different correction factors may be employed for each. The adjustment to the pachometer reading will be determined by averaging the difference of the measured bar depths and the pachometer readings.
- 6.4. Occasionally the Division of Materials will not find a bar at the designated location. If the penetration of the bit extends to 3 inches beyond the theoretical plan depth without evidence of a bar, the coring shall cease, and the core shall be removed and thoroughly inspected. If no evidence of a bar is noted, no further cores shall be taken at this location. Coring at other marked locations will proceed. It is of no value to take a core at a location where no pachometer reading exists. All core holes shall be filled by the contractor, with a Concrete Repair Patch (Cementitious) from the Division of Material's List of Approved Materials.
- 6.5. After core indicated adjustments have been applied to all pachometer readings, the pachometer readings will be evaluated and any areas which require penalties in accordance with Section 609.05 of the [Standard Specifications](#) will be determined and the penalties will be calculated by using the adjusted cover readings.
- 6.6. All areas of the same deficiency will be summed and the appropriate deduction factor applied. The total deduction is calculated in accordance with the following formula:

$$V_d = \frac{A_f}{A_s} \times V_s \times QAF$$

V_d = Total Volume Deduction

A_f = Total Factored Area

A_s = Total Slab Area Between Gutterlines (No deduction for drains, joints, etc.)

V_s = Total Slab Volume Between Gutterlines*

QAF = Quality Adjustment Factor (609.05)

* For slab span bridges, a maximum depth of 8 1/2" will be used in computing the slab volume.

The attached example is provided as a guide.

APPROVED

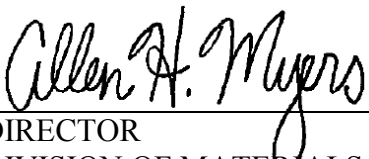

DIRECTOR
DIVISION OF MATERIALS

DATE

12/14/18

Kentucky Method 64-313-17
Revised 12/14/18
Supersedes KM 64-313-08
Dated 02/22/08

Attachment

Given : 2012 Specifications

Plan Cover = 2.5"

Deck Depth = 8.0"

Deck Dimensions = 212' x 44'

Skew = 20°

5' Space of Longitudinal = 5' ÷ cos 20° = 5.32'

Bid Price Concrete AA = \$775/cy

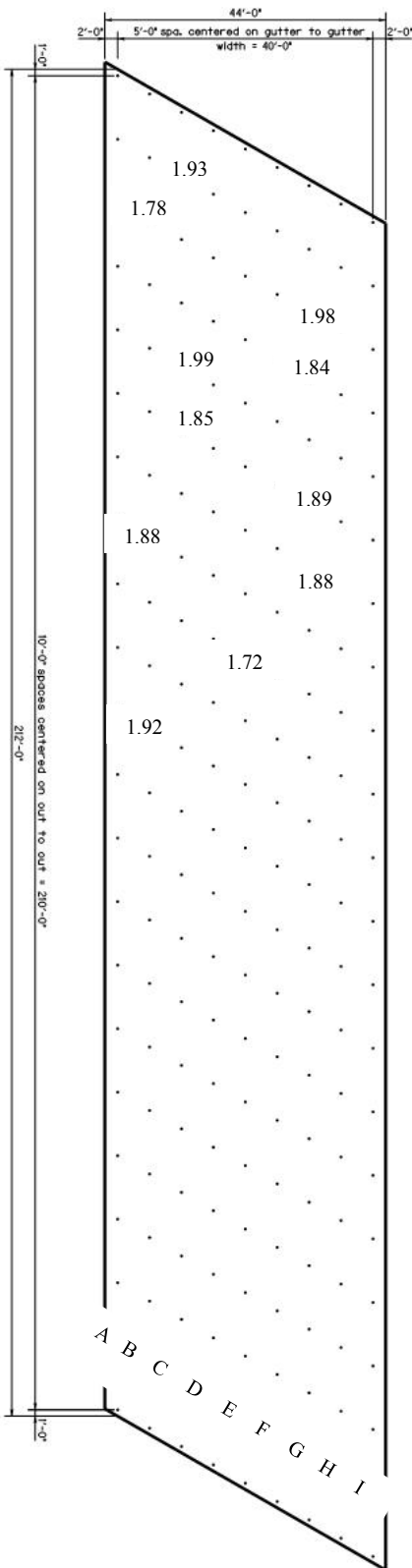

Core Data			
Grid Location	Pachometer Reading	Core Measurement	Difference
A4	1.78	1.85	0.07
B7	1.85	1.90	0.05
D10	1.72	1.70	-0.02

Deficient Cover Average = (0.07 + 0.05 + -0.02)/3 = 0.03

Adjusted Readings		
Grid Locations	Adjusted Reading	QAF
A4	1.81	0.25
A9	1.91	0.12
A12	1.95	0.12
B3	1.96	0.12
B6	2.02	0.06
B7	1.88	0.12
D10	1.75	0.25
F4	2.01	0.06
F5	1.87	0.12
F7	1.92	0.12
F8	1.91	0.12

Total Slab Area = $A_s = 212ft \times 44ft = 9328 sf$

Total Factored Area = $A_f = 10ft \times 5ft = 50 sf$

$V_s = \left(\frac{212ft \times 44ft}{9} \right) \times \left(\frac{8in}{12} \right) / 3 = 230.321 cy$

$V_d = \frac{A_f}{A_s} \times V_s \times QAF$

$QAF_{0.12} = 7$

$QAF_{0.25} = 2$

$V_{d0.06} = \left(\frac{50sf}{9328sf} \times 230.321cy \times 0.06 \right) \times 2 = 0.074 cy$

$V_{d0.12} = \left(\frac{50sf}{9328sf} \times 230.321cy \times 0.12 \right) \times 5 = 0.741 cy$

$V_{d0.25} = \left(\frac{50sf}{9328sf} \times 230.321cy \times 0.25 \right) \times 1 = 0.309 cy$

Row A has a different width for A_f due to the gutter line

Total Factored Area Row A = $A_{fA} = 4.5 \times 10 = 45 sf$

$V_{d0.12A} = \left(\frac{45sf}{9328sf} \times 230.321cy \times 0.12 \right) \times 2 = 0.266 cy$

$V_{d0.25A} = \left(\frac{45sf}{9328sf} \times 230.321cy \times 0.25 \right) \times 1 = 0.278 cy$

$V_{dtotal} = 0.074 + 0.741 + 0.309 + 0.266 + 0.278 = 1.668 cy$

Total Deduction = $V_{dtotal} \times \text{Concrete AA bid price}$

Total Deduction = $1.668 \times \$775 = \1292.70

EVALUATION OF CONCRETE CYLINDER RESULTS

1. SCOPE:

1.1. This method is a procedure for evaluating concrete cylinder strengths and for conducting investigations of in-place concrete. It covers job control procedures, which shall be implemented as soon as sufficient cylinder data becomes available, indicating either low or borderline strength. It also contains an adjustment table for various classes of portland cement concrete determined by cores to have low compressive strength.

1.2. Definition of a Concrete Cylinder Test:

1.2.1 Cylinders for all classes of concrete are taken in sets of two for 6 inch diameter by 12 inch height cylinders (6x12's) and in sets of three for 4 inch diameter by 8 inch height cylinders (4x8's) from a composite sample of concrete. Cylinders are tested and the average is treated as a single test except as provided in 1.2.2.

1.2.2. When a low cylinder result from a set is less than 75 percent of the other, the lower result will be considered invalid and the test value for the set will be the result of the cylinder(s) which tested higher.

2. ACCEPTANCE PROCEDURES:

2.1. When at any time the number of low strength tests for any class of concrete falls between 10 and 20 percent, the prime contractor shall be notified by the Project Engineer that his source should be advised to immediately take action to improve strength.

2.2. When at any time the number of low strength tests for any class exceeds 20 percent of the tests performed after the first 10 tests, all production of that class shall be stopped immediately until the prime contractor provides an acceptable proposal for improving strength. A low test is defined as the average strength of two cylinders obtained from the same sample of concrete which is less than the expected strength as specified.

2.3. When at any time cylinder strengths approach the criteria as hereinafter provided as a basis of requiring investigation of the adequacy of in-place concrete (Section 3) the Project Engineer should review the overall plant and batching operations to determine if batching errors or inconsistent plant operations are in evidence, review materials quality, review sampling techniques and procedures in molding, curing and testing specimens in efforts to detect and eliminate possible causes for low strength results.

Control charts such as the attached example are highly recommended as a means of

providing graphic comparison of concrete cylinder strengths to established limits, for indicating trends and in providing information regarding the effects of seasonal changes, changes in materials, changes in concrete operations, etc.

2.4. When at any time cylinder strengths become such that the in-place concrete requires investigation as outlined in Section 3, the Project Engineer should initiate the necessary investigation as outlined in Section 4 as soon as possible to avoid possible delays in final acceptance of the work.

3. CRITERIA FOR REQUIRING IN-PLACE INVESTIGATION OF CONCRETE REPRESENTED BY LOW TESTS:

3.1. Extent of low tests that will require investigation of in-place concrete they represent.

3.1.1. Concrete Classes AA, AAA, D, D Modified, M1, M2, or any other class of concrete with a specified f'_c of greater than 3500 psi: When either an individual test result falls more than 500 psi below f'_c or when the average of any 3 consecutive tests does not equal or exceed 100% of f'_c . (Where only two tests are available and their average does not equal or exceed 95% of f'_c).

3.1.2. Concrete Classes A, A Modified, P, or any other class of concrete with a specified f'_c of 3500 psi: When either an individual test falls below 3000 psi or when the average of any six consecutive tests does not equal or exceed 3500 psi. When less than six tests are available, critical test averages will be as tabulated below.

5 tests - 3465 psi
4 tests - 3395 psi
3 tests - 3290 psi
2 tests - 3150 psi

3.1.3. Concrete Class B: When either an individual test result falls below 2000 psi or when the average of any 6 tests taken in chronological order does not equal or exceed 2500 psi. When less than six tests are available, critical test average will be as tabulated below.

5 tests - 2475 psi
4 tests - 2425 psi
3 tests - 2350 psi
2 tests - 2250 psi

3.2. Low Cylinder results which do not require in-place investigation of the concrete as outlined in Section 3.1 will be considered within reasonable conformity with specifications.

4. PROCEDURE FOR INVESTIGATING IN-PLACE STRENGTH:

4.1. Concrete requiring in-place investigation shall, when possible, be investigated by taking

and testing of two cores from the concrete represented by each low test. In the case of unusually large pours involving numerous low tests, fewer cores may be obtained as deemed necessary while maintaining sufficient coring frequency to adequately represent the pour. Two cores shall be taken to represent each low cylinder test. Cores shall be obtained and tested in accordance with ASTM C42.

- 4.2. For those cases not allowing the taking of cores due to location or clearance problems, an investigation may consist of rebound hammer comparisons of the suspect concrete with concrete known to be represented by adequate specimens. The rebound hammer readings are used only for verification of the cylinder breaks. If the rebound hammer readings verify the low cylinder strengths, the Department may accept as outlined in Section 4.4.
- 4.3. When using the rebound hammer, observe the following rules:
 - 4.3.1. Concrete to be compared should have approximately the same age and moisture condition and the surface finish should be the same. Also, the direction of impact must be the same.
 - 4.3.2. Heavy textured, soft, or surfaces with loose mortar or masonry coatings shall be ground smooth with the abrasive stone prior to taking the readings.
 - 4.3.3. Distribute a copy of the results to the Central Lab project files and to the District Materials Engineer.
- 4.4. Latex Overlays, Low Slump Overlays, JPC 24/48/72, or M1/M2 (if depth or location is not adequate for coring) concrete will not require coring. Upon satisfactory completion of an in-place investigation for these classes, indicating failing but adequate strength, the Department may accept the concrete in accordance with Section 105.04 of the Kentucky Standard Specifications for Road and Bridge Construction by making a change order to document the basis of acceptance based on the following adjustments.

Average Cylinder strength - % of f'_c	% of unit bid price to be paid
95 - 100	100
90 - 94	90
85 - 89	80
80 - 84	70
75 - 79	60
Below 75	Remove and Replace

5.0. CORE STRENGTH EVALUATION:

5.1. Concrete Evaluation Criteria:

- 5.1.1. The concrete strength investigated by cores per paragraph 4.1 shall be considered

structurally adequate when the average of the two cores meet or exceed 90% of the specified f'_c for that class of concrete and may be accepted per paragraph 5.1.3

- 5.1.2. When the core strength does not meet 90% of f'_c , a design analysis shall be made to determine whether the actual concrete strength is adequate for the actual design stresses plus an adequate safety factor. If the concrete strength is not adequate, it shall be removed or sufficiently reinforced as may be required by the Department's engineers to meet that requirement.
- 5.1.3. When the core strength fails to meet contract requirements but is determined to have an adequate strength per paragraphs 5.1.1 or 5.1.2, the Department may accept the concrete in accordance with Section 105.04 of the Kentucky Standard Specifications for Road and Bridge Construction by making a change order to document the basis of acceptance based upon the following adjustments.

Average Core strength - % of f'_c	% of unit bid price to be paid
95 – 100	100
90 – 94	85
85 – 89	75
80 – 84	65
Below 79	Remove and Replace*

* At the option of the Engineer, if the concrete is structurally adequate the Engineer may elect to leave in place at 0% pay.

- 5.2.4. At the contractor's option, areas deficient in strength may be removed and replaced at no cost to the Department when the strength has been determined to be adequate but not meeting the specifications.

APPROVED

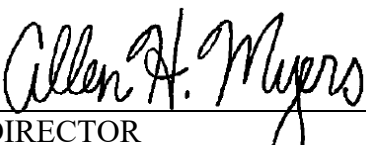

 DIRECTOR
 DIVISION OF MATERIALS

DATE

03/26/21

Kentucky Method 64-314-21
 Revised 03/26/21
 Supersedes KM 64-314-08
 Dated 06/16/08

Attachments

CYL

NO.	Mpa	PSI
1	31.44	4560
2	31.16	4520
3	31.02	4500
4	30.89	4480
5	30.06	4360
6	30.13	4370
7	30.34	4400
8	30.61	4440
9	29.79	4320
10	29.58	4290
11	27.99	4060
12	26.75	3880
13	26.48	3840
14	27.30	3960
15	27.99	4060
16	29.51	4280
17	31.86	4620
18	32.13	4660
19	32.96	4780
20	30.48	4420
21	29.51	4280
22	26.55	3850
23	27.44	3980
24	28.41	4120
25	25.17	3650
26	27.44	3980
27	29.51	4280
28	31.77	4600
29	32.27	4680
30	32.27	4680
31	33.65	4880
32	34.20	4960
33	31.86	4620
34	30.34	4400
35	28.41	4120

SAMPLE CONTROL CHART FOR AA CONCRETE

COMPRESSIVE STRENGTH IN (MPa) (PSI)

3447
(5000)

2758
(4000)

2068
(3000)

3447
(5000)

2758
(4000)

Cylinder

No.	PSI
1	4560
2	4520
3	4500
4	4480
5	4360
6	4370
7	4400
8	4440
9	4320
10	4290
11	4060
12	3880
13	3840
14	3960
15	4060
16	4280
17	4620
18	4660
19	4780
20	4420
21	4280
22	3850
23	3980
24	4120
25	3650
26	3980
27	4280
28	4600
29	4680
30	4680
31	4880
32	4960
33	4620
34	4400
35	4120

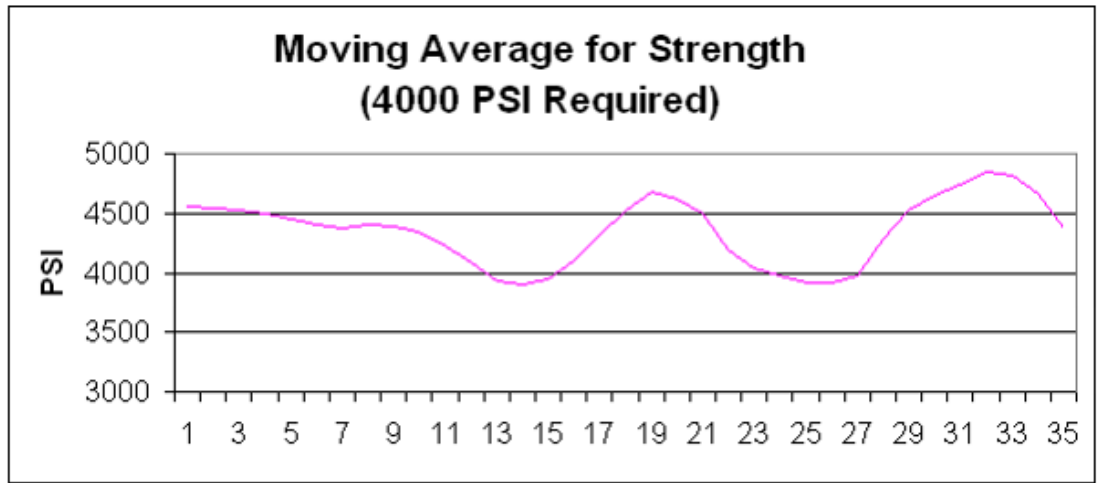
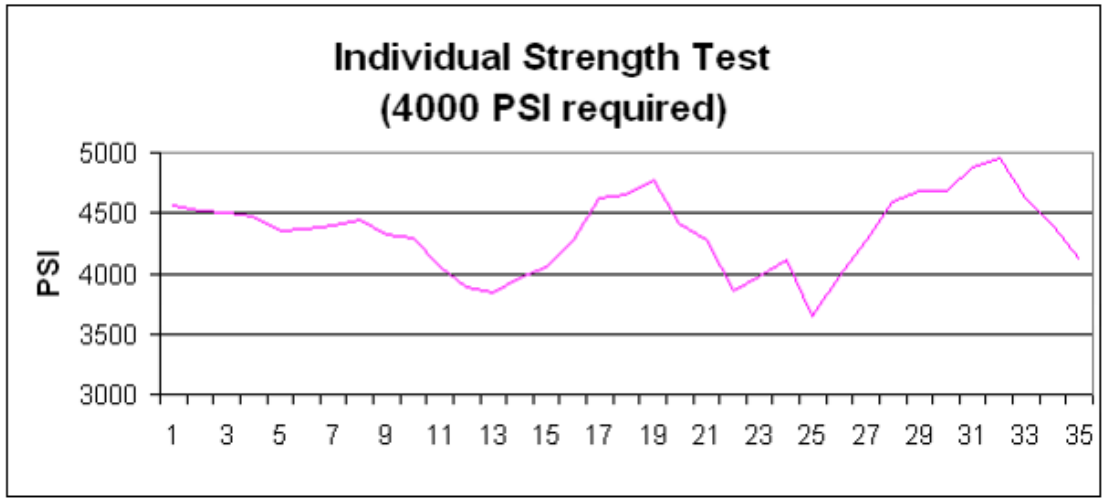

Cylinder No.	PSI		Cylinder No.	PSI
1	4560	4560	1	4560
2	4520	4540	2	4540
3	4500	4527	3	4527
4	4480	4500	4	4500
5	4360	4447	5	4447
6	4370	4403	6	4403
7	4400	4377	7	4377
8	4440	4403	8	4403
9	4320	4387	9	4387
10	4290	4350	10	4350
11	4060	4223	11	4223
12	3880	4077	12	4077
13	3840	3927	13	3927
14	3960	3893	14	3893
15	4060	3953	15	3953
16	4280	4100	16	4100
17	4620	4320	17	4320
18	4660	4520	18	4520
19	4780	4687	19	4687
20	4420	4620	20	4620
21	4280	4493	21	4493
22	3850	4183	22	4183
23	3980	4037	23	4037
24	4120	3983	24	3983
25	3650	3917	25	3917
26	3980	3917	26	3917
27	4280	3970	27	3970
28	4600	4287	28	4287
29	4680	4520	29	4520
30	4680	4653	30	4653
31	4880	4747	31	4747
32	4960	4840	32	4840
33	4620	4820	33	4820
34	4400	4660	34	4660
35	4120	4380	35	4380

CORING BRIDGE DECK OVERLAYS FOR THICKNESS

1. SCOPE: This method covers the procedure for obtaining drilled cores from bridge decks which have been overlaid and measuring the overlay thickness for determining conformity with the specified overlay thickness. This procedure is intended to apply to new construction only.
2. APPARATUS:
 - 2.1. Core Drill: A core drill of either the shot drill or diamond drill type capable of drilling a 1.7 inch diameter core.
 - 2.2. Measuring Devices: A scale or ruler having minimum graduations of 1/16 inch.
3. TEST SPECIMENS: Cores shall conform to [Kentucky Method 64-308](#) and shall have a nominal diameter of not less than 1.7 inches.
4. PROCEDURE:
 - 4.1. Units to be considered separately for coring are defined as 50 lineal feet of the total bridge width starting at the bridge end bearing the smaller station number, except that the final unit may represent 75 lineal feet.
 - 4.2. One random core shall be taken from each unit except as hereinafter noted.
 - 4.3. Overlay thickness shall be measured to the nearest 1/16 inch at four equally spaced locations around the circumference of the core. The measurements shall be that distance from the top of the core to the point of contact between the overlay and the deck concrete. The thickness shall be the average of the four measurements and shall be reported to the nearest 1/16 inch.
 - 4.4. If the overlay thickness determined from the initial core is equal to or greater than the design thickness the unit is considered acceptable for full payment except as provided under 4.6.
 - 4.5. If the overlay thickness determined from the initial core is deficient from 1/16 to 1/2 inch inclusive, two additional cores shall be taken from within the unit so that neither of the three core locations is within less than 15 feet of the other two locations. The reported overlay thickness shall be the average of three thicknesses with the following exceptions: (1) Overlay thicknesses exceeding design thickness by more than 1/8 inch shall be considered as design thickness plus 1/8 inch for the purpose of calculating the average thickness. (2) Overlay thicknesses which are deficient by more than 1/2 inch shall not be used in computing the average thickness of units but shall require the drilling of additional cores as required in 4.6. Units or portions of units which are deficient from 1/16 to 1/2

inch inclusive shall be subject to a reduced price in accordance with Section V of the applicable Special Provision.

- 4.6. When any core taken indicated an overlay thickness deficient by more than 1/2 inch, additional cores shall be taken at 10 feet intervals beginning at the deficient core and drilling parallel and perpendicular to the centerline until in each direction a core is obtained which is not deficient by more than 1/2 inch or until the limits of the structure prevent the drilling of further cores. The area of overlay to be removed and replaced shall be bounded either by lines perpendicular and parallel to the centerline which are perpendicular to and bisect lines connecting the last core showing deficiency in excess of 1/2 inch and the core showing deficiency of 1/2 inch or less, or the limits of the overlay, or both. If the removal area extends into an adjacent unit for which a pay factor has been previously established, that pay factor shall be applicable only to the portion of the unit not within the removal area. If the removal area is within or extends to a unit for which a pay factor has not been previously established, the pay factor shall be established by determining the thickness of the non removal area remaining within the unit, by taking 1 random core per 500 square feet or less of non removal area remaining within the defined unit.
5. REPORT: The report shall document the measured length of all cores and the location of all cores with respect to project stationing and the centerline of the bridge. Additionally, station references or other descriptions shall be documented to establish location and extent of areas deficient by more than 1/2 inch or areas subject to price reduction. The average thickness for each unit subject to averaging shall be reported.

APPROVED



DIRECTOR
DIVISION OF MATERIALS

DATE

02/22/08

Kentucky Method 64-315-08
Revised 02/22/08
Supersedes 64-315-03
Dated 02/17/03

SAMPLING PORTLAND CEMENT

1. SCOPE: This method covers the procedure for sampling portland cement.
2. APPARATUS:
 - 2.1. A plastic moisture-proof, jug with an air-tight, screw-top lid.
 - 2.2. When applicable a clean device for obtaining samples such as a bucket, shovel, scoops, etc.
3. SAMPLE SIZE: One gallon.
4. SAMPLING PROCEDURE:
 - 4.1. Samples shall be taken by a concrete producer representative and witnessed by a KYTC employee. Samples shall be representative of the cement actually being used in the project. Obtain approximately one-half of the total project samples from the concrete plant weigh hopper or storage bin and the other one-half from the cement transport trucks. The concrete producer is responsible for insuring that the samples are obtained without contamination.
 - 4.2. Sampling from Transport Truck:
 - 4.2.1. From Top of Truck: Take sample from top of the truck prior to unloading. Scrape back the cement in an area about two feet in diameter and to a depth of approximately 12 inches and then take the sample.
 - 4.2.2. From Discharge Line of Truck: If the discharge line is equipped with a sampling valve, take the sample at the halfway point of unloading. If the sample is taken from the end of the discharge line, take the sample at the halfway point of unloading.
 - 4.3. Sampling from Concrete Plant Storage:
 - 4.3.1. Sampling from Cement Storage Bin: Take sample from storage bin by means of approved sampling device (draw off port).
 - 4.3.2. Sampling from Weigh Hopper: Take sample from weigh hopper by means of approved sampling device (draw off port). Advise plant operator to make sure that weigh hopper is free of other material such as fly ash.
 - 4.3.3. Sampling from Weigh Hopper Discharge: Take sample from material discharged from the weigh hopper. Plant representative must insure sample does not become contaminated with other material in the weigh hopper or by material in the sampling

device.

4.4. Sampling Precautions:

- 4.4.1. Fill sampling container as full as possible to avoid aeration and moisture absorption of the sample.
- 4.4.2. Never take a cement sample from a belt used to convey aggregates.
- 4.4.3. Never take a cement sample from off the ground.
- 4.4.4. Use great care and caution to insure that cement samples do not become contaminated with sand, fly ash, dirt, air-entraining admixtures, etc.
- 4.4.5. Observe all necessary safety precautions.

APPROVED

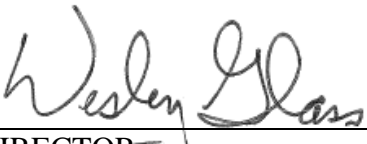

DIRECTOR
DIVISION OF MATERIALS

DATE

03/25/08

Kentucky Method 64-316-08
Revised 03/25/08
Supersedes KM 64-316-03
Dated 02/17/03

Kentucky Method 64-317-08
Revised 02/22/08
Supersedes KM 64-317-02
Dated 12/23/02

COMPRESSIVE STRENGTH OF CYLINDRICAL CONCRETE SPECIMENS
USING NEOPRENE CAPS

Perform Test Procedure according to ASTM C 1231 with no exceptions.

APPROVED



DIRECTOR
DIVISION OF MATERIALS

DATE

02/22/08

Kentucky Method 64-317-08
Revised 02/22/08
Supersedes KM 64-317-02
Dated 12/23/02

Kentucky Method 64-318-08
Revised 02/22/08
Supersedes KM 64-318-05
Dated 01/04/05

TEMPERATURE OF FRESHLY MIXED CONCRETE

Perform Test procedure according to ASTM C 1064 with the following exceptions:

1. Obtain the sample in accordance with [KM 64-301](#), Sampling Fresh Concrete.

APPROVED



DIRECTOR
DIVISION OF MATERIALS

DATE

02/22/08

Kentucky Method 64-318-08
Revised 02/22/08
Supersedes KM 64-318-05
Dated 01/04/05

Kentucky Method 64-320-16
Revised 06/24/16
Supersedes KM 64-320-08
Dated 03/21/08

METHOD FOR APPROVAL OF USING
SELF CONSOLIDATING CONCRETE (SCC)

1. SCOPE: This method covers the process for precast plants to obtain approval for use of SCC in precast products. The concrete producing plant is required to be located on the site of the precast plant.
2. BASIC REQUIREMENTS:
 - 2.1. Qualified manufacturers must submit a revised quality control plan utilizing SCC to the Kentucky Transportation Cabinet (KYTC) for approval, and meet all applicable requirements of the [Kentucky Standard Specifications for Road and Bridge Construction](#) and the Prestress/Precast Manual.
3. PROCEDURES:
 - 3.1 Submit a written request for SCC approval to: Director, Division of Materials, 1227 Wilkinson Boulevard, Frankfort, KY 40601. The request must include:
 - 3.1.1. Mix Designs.
 - 3.1.1.1. Minimum cementitious material - 564 pounds per cubic yard.
 - 3.1.1.2. Maximum w/c ratio of .46 (Type F or G high-range water reducer required).
 - 3.1.1.3. Air content of 6% \pm 2%
 - 3.1.1.4. Spread limits (Indicate low end and high end of spread range)
 - 3.1.2 SCC quality control procedures.
 - 3.1.3 Plastic test methods and limits imposed.
 - 3.1.4 SCC plant production records.
 - 3.1.5 28 day strength data.
 - 3.1.6 Core testing data, if available.
 - 3.2 If qualified manufacturers meet the requirements set forth herein, KYTC will require a SCC demonstration for each qualifying plant. This demonstration should include representation from admixture and cement manufacturers and plant officials. A plant may receive a 90-day conditional approval if it can demonstrate a good quality mix using SCC. These approvals

will be granted on a case by case basis. The KYTC will need to witness a SCC batch at the minimum and maximum spread indicated on the submitted mix designs.

- 3.3 During the 90-day conditional approval, KYTC will initially require that each plant provide the following:
 - 3.3.1 Obtain 4 cores from the demonstration pours and submit them to an independent lab for air analysis in accordance with the current edition of ASTM C-457.
 - 3.3.2 Perform and record the spread, visual rating of spread and temperature of every batch of SCC (spread test should be performed next to forms if transporting SCC by any method other than cranes) for the first 30 days of production. Provide these test results to the Division for review. This requirement may be waived for plants approved in another state using SCC for over one year.
 - 3.4 Continue to use the approved mix design (unless additional mix designs are submitted and approved prior to use).
 - 3.5 Maintain the spread approved by KYTC during demonstration and visually inspect for segregation and any paste outline around spread. Perform test in accordance with ASTM C-1611 and document all results.
 - 3.6 Have a working moisture probe and compensator or KYTC approved alternative.
4. **DISQUALIFICATION OF MANUFACTURERS:** If the 90-day conditional approval procedures are not followed or if any problems arise that cannot be immediately corrected, the plant will be disqualified to use SCC in any KYTC product.

APPROVED

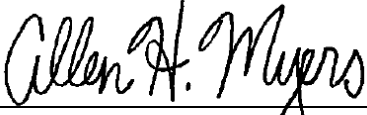

DIRECTOR
DIVISION OF MATERIALS

DATE

06/24/16

Kentucky Method 64-320-16
Revised 06/24/16
Supersedes KM 64-320-08
Dated 03/21/08

ESTIMATING CONCRETE STRENGTH BY THE MATURITY METHOD

1. SCOPE:
 - 1.1. This method is a modification of ASTM C 1074 covering the procedures for estimating concrete strength by means of the maturity method.
 - 1.2. The maturity method may be used for opening concrete pavement to traffic. This method may be used for Class P, PCCP/24, PCCP/48, and PCCP/72.
 - 1.3. A relationship must be established between the maturity values and the concrete strength as measured by cylinder testing. The development of the maturity-strength curve shall be performed using project materials and the proposed concrete mix design. The contractor shall be responsible for the development of the maturity curve. The District Materials Engineer shall monitor the curve development. The temperature monitoring process of the constructed pavement shall be the responsibility of the contractor and shall be monitored by the Engineer. Determining that sufficient strength has been achieved shall remain the responsibility of the Engineer. Acceptance of the concrete shall be based upon the 28-day cylinder strength.
 - 1.4. Changes in material sources, proportions, admixtures, and mixing equipment all affect the maturity value of a given concrete mixture. Therefore, development of a new maturity curve is required for any change to a concrete mix unless the District Materials Engineer deems otherwise.
2. APPARATUS: A device is required to monitor and record the concrete temperature as a function of time. Use a commercial maturity instrument that automatically computes and displays the temperature-time factor (TTF).
3. MATURITY FUNCTIONS:
 - 3.1. There are two alternate functions for computing the maturity value from the measured temperature history of the concrete; the Nurse-Saul equation and the Arrhenius equation. The Department uses the Nurse-Saul equation.

- 3.2. The maturity function, known as the Nurse-Saul equation, is used to compute the TTF as follows:

$$M(t) = \Sigma(T_a - T_o) \Delta t$$

where: $M(t)$ = the TTF at age t , degree-days or degree-hours,
 Δt = a time interval, days or hours,
 T_a = average concrete temperature during time interval, Δt , °C, and
 T_o = datum temperature = -10 °C.

4. PROCEDURE TO DEVELOP STRENGTH-MATURITY RELATIONSHIP:

- 4.1. Prepare at least 15 cylindrical specimens according to [Kentucky Method 64-305](#). The mixture proportions and constituents of the concrete shall be the same as the concrete whose strength will be estimated using this practice. The concrete shall be produced using the same equipment as that which will produce concrete for the project. The cylinders may be cast at the concrete plant or the job site. Since there is a direct relationship between the w/c (water/cement) ratio and strength, the concrete used to develop the maturity-strength relationship shall be at the maximum w/c ratio expected during production.
- 4.2. Embed temperature sensors in the centers of at least two cylinders. Connect the sensors to one or more maturity meters. Use the average of the readings to develop the maturity-strength curve.
- 4.3. Moist cure the specimens in a water bath or in a moist room meeting the requirements of KM 64-305.
- 4.4. Perform compression tests at five different ages. Test three specimens at each age and compute the average strength. If a low test result is due to an obviously defective specimen, discard the low test result. The tests shall be spaced such that they are performed at somewhat consistent intervals of time and span a range in strength that includes the opening strength desired. The table below gives suggested test times. Test 3 is the target test. This is only a guide and may need to be modified depending on specific mixtures and conditions.

APPROXIMATE TEST TIMES

Mix (strength psi)	Test 1	Test 2	Test 3	Test 4	Test 5
Class P	2 days	3 days	4 days	5 days	6 days
Class PCCP/24	6 hours	10 hours	12 hours	14 hours	24 hours
Class PCCP/48	24 hours	36 hours	48 hours	60 hours	72 hours
Class PCCP/72	48 hours	60 hours	72 hours	84 hours	96 hours

- 4.5. At each test age, record the average maturity value for the instrumented specimens.
- 4.6. Use the spreadsheet provided by the Department to determine the maturity-strength relationship. This spreadsheet can be found on the Materials Web Page at <http://transportation.ky.gov/materials>. The TTF

number corresponding to the desired compressive strength shall be used to determine when the concrete has reached desired strength.

- 4.7. The computed R^2 value obtained from regression analysis of the maturity-strength relationship shall be 0.95 or higher. The R^2 value can be found on the maturity curve chart. When R^2 value is below 0.95 the curve is unacceptable and a new curve will be required.
5. PROCEDURE TO ESTIMATE IN-PLACE STRENGTH:
 - 5.1. Insert temperature sensors at mid-depth of the pavement and a minimum of 12 inches from the edge of the concrete. They should be placed in the plastic concrete as soon as possible. Avoid placing the sensors near reinforcing steel. A threaded rod with a wing nut may be used to insert the sensors in the pavements and immediately removed. Consolidate the concrete around the sensor as needed. The rod can be marked for various insertion depths. This device will allow the placement of the sensors with minimal disturbance to the concrete. Sensors should be placed in the concrete where the temperatures are expected to be the coolest.
 - 5.2. For a normal day production, randomly place 2 sensors to determine the maturity. They shall be located in the last 100 feet of pavement placed.
 - 5.3. Connect the sensors to maturity instruments and activate the recording devices as soon as is practicable.
 - 5.4. When the strength at the location of a sensor is to be estimated, read the maturity value from the instrument. The strength of the concrete can be determined from the spreadsheet or calculated from the curve equation.
 6. VALIDATION:
 - 6.1. Conduct field validation on the first day of production. Validation shall consist of testing a set of 3 cylinders near the TTF value for the required strength to determine if the concrete is represented by the current maturity curve.
 - 6.2. Test for air, slump, and temperature. Cast a set of 3 cylinders at the job site. Place a sensor at mid point of a cylinder and connect it to a meter. Field cure cylinders made for validation in accordance with [KM 64-305](#).
 - 6.3. If the cylinder strength is equal to or above the original maturity curve, the curve is considered validated and validation shall be conducted weekly thereafter. A value that is more than 10% below the expected strength is unsatisfactory and a new curve is required. If 3 consecutive tests fall between 0% and 10% below the curve, a new curve is required.

References:

Iowa Department of Transportation, "Method of Testing the Strength of Portland Cement Concrete Using the Maturity Method", 1997.

Indiana Department of Transportation, "Strength of Portland Cement Concrete Pavement (PCCP) Using the Maturity Method, ITM 402-99T", 1999.

Mohsen, J. P., Kessinger D. T., Roach, B. L., "Maturity Method Applied to Highway Construction – The Kentucky Experience", 2001. Transportation Research Board Meeting, 2001.

APPROVED

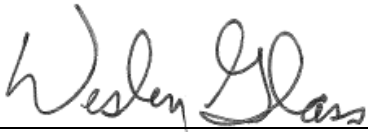

DIRECTOR
DIVISION OF MATERIALS

DATE

02/22/08

Kentucky Method 64-322-08
Revised 02/22/08
Supersedes KM 64-322-02
Dated 11/15/02

Kentucky Method 64-323-17
Revised 02/22/17
Supersedes KM 64-323-16
Dated 03/08/16

QUALIFICATION PROCESS FOR PRODUCERS OF READY MIX CONCRETE

1. DESCRIPTION -

1.1 Ready Mix Concrete includes but is not limited to suppliers producing plastic concrete to a Kentucky Transportation Cabinet (KYTC) project.

2. SCOPE –

2.1 This method covers the qualification requirements of ready mix concrete facilities to assure that adequate measures are taken during production to consistently produce high quality concrete.

2.2 This method will be used on all KYTC projects.

2.3 This method does not purport to address all of the safety concerns, or any associated with its use. It is the responsibility of the user of this method to establish appropriate safety and health practices and determine the applicability of regulatory limitations prior to use.

3. BASIC REQUIREMENTS –

3.1 The plant must maintain or have ready access to an approved testing facility for the purpose of quality control (QC) testing.

3.2 Concrete Plant Application.

3.3 Qualified production plants must have at least one qualified Quality Control (QC) Technician. The qualified QC Technician must be certified as an ACI Level I Concrete Technician, KCA Level II Technician and a Qualified Concrete Aggregate Technician or KYTC Qualified Aggregate Technician. One technician having all qualifications or several technicians having individual qualifications may fulfill this requirement. If an independent or aggregate supplier's lab is utilized, for aggregate testing, the aggregate technician must be an employee of that laboratory and be a KYTC Qualified Aggregate Technician. The concrete technician(s) must be employed by the concrete company and at the plant location during batching operations for KYTC projects.

3.4 All ingredient materials must be from an approved source on [KYTC's List of Approved Materials](#).

4. APPROVED TESTING FACILITY –

- 4.1 This program requires all tests to be conducted at facilities approved by the KYTC. Each producer must establish and maintain its own KYTC qualified laboratory for the performance of QC testing, or the KYTC will consider a producer's request to utilize an approved independent laboratory. If an aggregate supplier's or independent laboratory is utilized it must be inspected and approved by the KYTC and have qualified personnel employed. The equipment required for an approved laboratory shall be sufficient to perform the required tests referenced in the applicable AASHTO Standards, ASTM Standards, Kentucky Methods, and the current Kentucky Standard Specifications for Road and Bridge Construction that detail the production of concrete. The producer will be responsible for calibration of testing equipment and must maintain records on instrument calibration at the plant/laboratory. The KYTC will require a demonstration of the equipment and procedures.

5. QC TECHNICIAN –

- 5.1 All plastic concrete samples must be taken and tested by an ACI Level I Concrete Technician. All aggregate samples must be taken and tested by a Qualified Concrete Aggregate Technician (see Note 1) or KYTC Qualified Aggregate Technician. All mix design submittals and changes must be submitted by a KCA Level II Technician employed by the company. The designated QC technician(s) will be responsible for the overall QC at the plant. The KYTC will require a demonstration of the equipment and procedures used by the technician(s).

Note 1 – A Qualified Concrete Aggregate Technician is considered qualified to perform aggregate testing solely for the company the individual is employed. In order to be recognized as a Qualified Concrete Aggregate Technician, aggregate testing proficiency will be verified and one of the following is required:

- 1) Have successfully completed the KYTC Qualified Aggregate Technician or KCA Level II Certification course. Maintaining certification after expiration is not required if aggregate testing responsibilities have not been interrupted.
- 2) Aggregate Technician Certification from another agency if reviewed and deemed acceptable.

6. PLANT QUALIFICATION PROCESS –

- 6.1 Submit a Concrete Plant Application for qualification to DIRECTOR, DIVISION OF MATERIALS, 1227 WILKINSON BOULEVARD, FRANKFORT, KY 40601-1226.
- 6.2 After submittal and approval of the application, KYTC personnel will schedule an on-site inspection. The on-site inspection will verify that the Producer maintains or has access to all the required testing and production equipment and that at least one qualified technician is on-site and will be present when material is being produced under this program. The testing facilities and equipment are subject to inspection. If either the Producer or the Laboratory does not meet KYTC requirements, the Producer will be informed of the deficiencies in writing. Once the deficiencies have been addressed, the Producer may again submit a request for qualification in writing to the Director of the Division of Materials.

7. QUALIFICATION FOR PARTICIPATION IN THE PROGRAM –

7.1 If the KYTC has approved the Producer’s plant and the on-site inspection confirms that the initial program requirements have been met, the KYTC will issue a letter qualifying the plant for participation in the program for one year. At least once a year the Division will conduct on-site inspections and if all requirements are continuing to be met, the plant will be re-qualified for participation in the program for that year. Random in- depth inspections and materials sampling may be conducted at any time by the KYTC to verify compliance with the program requirements. Failure to perform all of the program requirements will result in disqualification of the Producer.

8. SAMPLING AND TESTING PROCEDURES –

8.1 PRODUCER’S QC - The Producer’s QC samples are intended for use by the Producer to monitor the quality of material being produced and shipped.

8.1.1 SPECIFICATIONS - The Producer is to perform all applicable sampling and testing in accordance with the current Specifications

8.1.2 COMPARISON TESTING – Samples of materials taken by KYTC personnel during plant visits may be split with half of the sample being tested by the Producer and half of the sample tested by KYTC.

8.2 PRODUCTION –

8.2.1 Check, record and file all test results obtained during concrete production and provide to the Transportation Cabinet upon request.

8.3 SAMPLING/CERTIFICATION FREQUENCIES -

8.3.1 Sampling and Testing:

Coarse Aggregate, Fine Aggregate – At a minimum, sample weekly and test according to KY Specifications for gradation and minus 200 wash test. Fine aggregates will not require a minus 200 wash test.

Slump/Spread, Temperature, Air Content and Unit Weight – At a minimum, the first unit and at least every 100 cubic yards. Note: Pavement concrete will be sampled and tested at first unit and every 500 cubic yards thereafter for each day’s production (does not include JCP 24/48/72). Test according to the applicable ASTM or Kentucky Methods.

Moisture Contents – At a minimum, once per day before production begins and any time a difference in moisture is seen in the mix or the aggregates. Test according to Kentucky Method 64-306.

8.3.2 Certifications:

Obtain certifications for each shipment of Cement, Fly Ash, Admixtures (Mineral and Chemical), Aggregate, and all incidental items. Maintain certification files for a minimum of three (3) years after project completion at the production facility or a central location. Review certification statements to insure that all KY Specifications are met prior to use of these materials in any KYTC mixes.

8.3.3 Record Keeping:

Provide sample of forms used to record inspections and test results.

9. TEST FAILURE RESOLUTION –

9.1 Tests performed on materials prior to production, during production and post-production will be required to meet all of the applicable specifications and references found in the Specifications. Separate and identify materials or products that do not comply with Specifications. If an aggregate sample fails, retest immediately. If the retest fails, reject or remove all failing material from stockpiles or bins. Test the next two loads of aggregate and if they pass, return to the standard frequencies. If either sample fails, continue rejecting the material and test until two consecutive loads pass.

10. SAMPLE IDENTIFICATION AND RECORD KEEPING –

10.1 Identify Producer's QC samples with consecutive numbers. {QC1, QC2, etc.} Number the samples consecutively for the entire calendar year.

10.2 Retain QC data and material certifications for at least three (3) years after project completion. Make all data available to the KYTC for review upon request.

10.3 Include identifications on all QC test reports.

11. DIVISION QA PROCEDURES –

11.1 Quality Assurance Samples – The KYTC's QA samples are intended to verify the project specifications. Ingredient materials will be sampled at the plant for KYTC projects and tested for conformance to the KYTC standard specifications. Samples will be taken according to the [Materials Field Sampling Manual](#). If QA samples fail, there will be a potential price deduction and an investigation will be performed.

11.2 The KYTC may sample incoming material during in-depth plant visits for testing and evaluation. The material sampled does not have to be material that is incorporated into products produced for the KYTC. KYTC will observe the technicians testing procedures to evaluate their ability to perform the required tests.

11.3 Resolution procedures will be in accordance with section 113.07 of the Kentucky Standard Specifications.

12. DISQUALIFICATION OF PRODUCERS – Producers that are qualified under these requirements may be disqualified based on the procedures below:

In-depth Audits – Randomly check 3 days of production. If one day has a deviation from KYTC requirements, check an additional 2 days for a total of 5 days of production. A letter will be sent to the local plant staff listing all deficiencies and assigning a reasonable date for completion. All deficiencies must be addressed in writing, listing corrective actions taken or to be taken by the due date, and the letter must be signed by the Company President. If all deficiencies are resolved, excluding fraud and falsifying documentation, the producer will remain on the List of Approved Materials.

If an in-depth audit finds deficiencies, an additional in-depth audit will be conducted after corrective actions are to have been completed. New deficiencies found must be addressed in writing as above. Recurring deficiencies will result in the producer being removed from the List of Approved Materials. A notification letter will be sent containing the reasons for removal and appeal process to achieve probationary status. Absent errors or omissions on the part of the Department the plant's suspension will be for a period of no less than 30 calendar days.

Probationary status is achieved through the appeals process. A producer may request a probationary hearing before the appeals board after receiving the notification of removal from the List of Approved Materials. The producer shall make this request in writing; stating the reason for the appeal; and providing all supporting documentation. The Department will hold an appeals hearing within 30 days of receiving the request. The appeals board is composed of the Branch Manager of Structural Materials, a representative from the Division of Construction and the Director of the Division of Materials. If the appeal items are traceable to a field-installed product, the appeals board will also include a representative from the affected District Office. The Department will issue the appeal board findings within 15 days of the hearing.

If the situation cannot be resolved through the appeal process, the company may request a 13B administrative hearing by sending a request to the Office of Legal Services, who will then forward the request for a hearing to the Office of Attorney General.

If, through the appeal process probationary status is granted, the probation period will be a minimum of 12 months and, depending on previous deficiencies, will require varying documentation to be submitted throughout the term.

While on probation, additional audits will be conducted. If a producer is found to have no deficiencies during the probation period they will be return to normal status. However, if there is a reoccurrence the producer will be removed from the List of Approved Materials for a period as follows:

Individual in-depth issues are still present – 60 Calendar days

More than 2 occurrences of either missing Batch Tickets, Gradations, Daily Moistures, Plastic Testing, Scale Calibrations, Truck Performance Inspections, or Expired Lab Qualifications not noted on previous in-depth – 60 Calendar days

Concrete mixtures sent out with failing ingredient materials or plastic test results (without proof of modification or passing field tests for plastic tests) – 90 Calendar days.

Exceeding batch tolerances – w/c ratio or total cementious – 60 Calendar days All other batch tolerances deficiencies – in conjunction with other deficiencies – 60 Calendar days.

Fraud and Falsifying test results or inspections – 12 months to permanent

Except for fraud and falsifying test results – penalties are cumulative up to 120 calendar days. Additionally, if a company has been previously suspended in the last 3 years the penalties are doubled (cumulative up to 240 Calendar days).

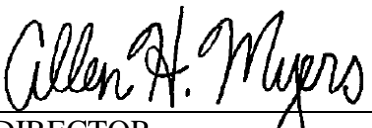
APPROVED 
DIRECTOR
DIVISION OF MATERIALS

DATE 03/08/16

Kentucky Method 64-323-17
Revised 02/22/17
Supersedes KM 64-323-16
Dated 03/08/16

Kentucky Method 64-324-08
Revised 02/22/08
Supersedes KM 64-324-06
Dated 03/03/06

UNIT WEIGHT OF CONCRETE

Perform tests in accordance with ASTM C138.

Perform calibrations in accordance with ASTM C29 with the following permitted as an alternate:

1. Perform the initial calibration in accordance with ASTM C29.
2. Perform subsequent calibrations using the following calculation:

$$V = \frac{3.141593 (D^2) (H)}{6912}$$

V = Volume (ft³)
D = Average bucket inside diameter (in.)
H = Average inside height of bucket (in.)

NOTE: Two (2) measurements shall be taken for each dimension (90° apart) and averaged. Measurements shall be made with a caliper and recorded to three decimal places.

3. If the volume from calculation differs from the original calibration by .005 ft³ or more use the calibration described in ASTM C29.
4. If the bucket is out of round, has gouges or build up of concrete, correct or replace the bucket. Perform a new calibration in accordance with ASTM C29.

APPROVED



DIRECTOR
DIVISION OF MATERIALS

DATE

02/22/08

Kentucky Method 64-324-08
Revised 02/22/08
Supersedes KM 64-324-06
Dated 03/03/06

ACCEPTANCE PROCEDURES FOR FLY ASH FOR CONCRETE

1. SCOPE: Fly ash used in concrete on KYTC construction projects must be on the KYTC's "List of Approved Materials". The following requirements must be met, by the supplier, to gain inclusion on the list and be able to furnish fly ash for acceptance on the basis of certification:
2. CHEMICAL TREATMENT (OPTIONAL)
 - 2.1 Request for Chemical Treatment Approval
 - 2.1.1 Submit a written Quality Control (QC) procedure and include:
 - Identify treatment
 - Dosage and method of application of chemical treatment
 - QC procedures utilized to assure the fly ash has been properly treated
 - Proposed field verification procedure to quantify chemical treatment
 - Proposed trip ticket indicating treatment of fly ash and dosage, including statement of any known admixture incompatibilities
 - 2.1.2 Three mix design evaluations will be required with each design utilizing treated and untreated fly ash for a total of six designs. Each design shall be based on the KYTC Class AA concrete specifications. Each Design must utilize a different set of KYTC approved ingredient materials (cement, coarse and fine aggregate, admixtures, etc.). The mixes shall be tested with varying air entrainment dosages. The dosages shall start at 0.0 ounces/cwt and increase at 1.0 ounce/cwt increments until the mix achieves an 8% plastic air content. Each mix shall also include test data for slump, compressive strength (3, 7, 28 and 56 days) and temperature. Tests shall be performed in accordance with the Kentucky Method that represents each test.
 - 2.1.3 Mix designs shall be submitted and approved by the Division of Materials prior to laboratory testing.
 - 2.1.4 Hardened air results (ASTM C457) shall be provided for the treated and untreated mixes that most closely obtain a plastic air content of 4.0%, 6.0% and 8.0%.
 - 2.1.5 All laboratory testing shall be witnessed and reported on by a CCRL accredited laboratory technician from a laboratory jointly accepted by the fly ash supplier and the KYTC.
3. SATISFACTORY PAST RECORD
 - 3.1. Fly ash from the proposed source shall have met ASTM C618 requirements for the previous three months.

- 3.2. Fly ash from the proposed source, that has not received an approved chemical treatment, shall have had a loss on ignition (LOI) of 4.0% or less and a fineness in conformance with ASTM C618 for the previous three months.
- 3.3 Fly ash from the proposed source, that has received an approved chemical treatment, shall have had a loss on ignition (LOI) of 6.0% or less and a fineness in conformance with ASTM C618 for the previous three months.

4. SATISFACTORY TEST RESULTS AND INSPECTIONS BY THE DIVISION OF MATERIALS

- 4.1. The initial source sample shall meet the requirements of ASTM C618 as modified by Section 844 of the Kentucky Standard Specifications for Road and Bridge Construction.
- 4.2. The Division of Materials will conduct periodic inspections and obtain split samples of fly ash from the producer for each approved silo. Inspections and test results must be acceptable by the Division to remain on the List of Approved Materials.

5. SATISFACTORY QUALITY CONTROL PROGRAM

- 5.1. The fly ash distributor shall submit a quality control plan to the Division of Materials for review and approval.
- 5.2. A graduate chemist or laboratory technician shall be employed at the power plant site to perform tests for LOI, moisture and fineness. If a laboratory technician is utilized, a formal in-house competency review of the technician must be performed at a minimum of once per year.
- 5.3. A suitable testing facility located at the power plant with the necessary equipment to perform LOI, moisture, and fineness tests shall be provided by the distributor.
- 5.4. Complete ASTM C618 tests shall be performed at least monthly from composite samples for each approved silo with a copy of the results forwarded to the Division of Materials. All tests reports submitted shall show the date of sampling at the power plant for each sample. No more than sixty days shall have elapsed between the sampling date and the date test reports are received by the Division of Materials.
- 5.5. LOI, moisture, and fineness tests in accordance with ASTM C618 shall be performed at least twice per week for each approved silo. These reports are to be submitted with the complete ASTM C618 test data specified above.
- 5.6. Laboratories performing tests on fly ash for conformance to ASTM C618 (monthly samples) shall participate in the laboratory evaluation program conducted by the Cement and Concrete Reference Laboratory (CCRL) of ASTM. This requirement does not apply to routine process control testing performed at the power plant for fineness, moisture, LOI, and uniformity. The Distributor or CCRL shall forward a copy of the laboratory inspection report and Certificate of Accreditation to the Division of materials.

- 5.7. Sources will be removed from the “List of Approved Materials” when monthly tests reports are not received for two consecutive months or when less than eight monthly reports are received for any twelve month period. Allowances for power plant down time shall be given provided documentation is submitted listing the time period that the power plant (Unit number) was down.
- 5.8. All test results, that is, both the complete ASTM C618 and the twice weekly or more frequent tests for LOI, moisture and fineness; shall be kept by the distributor for a period of not less than three years.

6. SATISFACTORY SHIPPING REQUIREMENTS

- 6.1. Each shipment intended for use on a KYTC project shall be accompanied by a signed certification from the supplier stating that the fly ash complies with ASTM C618 except as modified by KYTC’s specifications for LOI.
- 6.2. Each shipment intended for use on a KYTC project shall be accompanied by the latest actual test results for LOI and Fineness.
- 6.3. The certification must include the silo identification that the shipment came from.

APPROVED

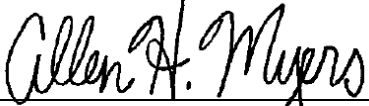

DIRECTOR
DIVISION OF MATERIALS

DATE

11/04/21

Kentucky Method 64-325-21
Revised 11/04/21
Supersedes KM 64-325-08
Dated 06/22/08

Attachments

**Kentucky Transportation Cabinet (KYTC)
Division of Materials**

QUALITY CONTROL PLAN FOR FLY ASH

I. DISTRIBUTOR

NAME:

ADDRESS (STREET OR PO BOX):

CITY:

STATE:

ZIP CODE:

CONTACT PERSON:

PHONE NUMBER:

CLASS OF FLY ASH: CLASS F CLASS C

II. POWER COMPANY

NAME:

POWER PLANT NAME:

POWER PLANT LOCATION:

PHONE NUMBER:

UNIT NUMBERS THAT PRODUCE KYTC SPECIFICATION FLY ASH:

LIST SILO(s) USED FOR STORAGE:

LIST THE UNIT NUMBER(s) THAT SUPPLIES EACH SILO.

SILO#	: UNIT#	SILO#	: UNIT#
SILO#	: UNIT#	SILO#	: UNIT#
SILO#	: UNIT#	SILO#	: UNIT#
SILO#	: UNIT#	SILO#	: UNIT#

LIST COMMENTS, IF ANY:

III. LABORATORY FOR (WEEKLY) SAMPLING AND TESTING

LABORATORY NAME:

ADDRESS (STREET OR PO BOX):

CITY:

STATE:

ZIP CODE:

CONTACT PERSON:

PHONE NUMBER:

NAME OF SAMPLING PERSON:

NAME OF TESTING PERSON:

IS LABORATORY CCRL ACCREDITED? YES NO

DOES THIS LABORATORY HAVE THE EQUIPMENT TO TEST FOR LOI (ASTM C311),
MOISTURE (ASTM C311), AND FINENESS (ASTM C430)?
 YES NO

DESCRIBE THE LABORATORY BUILDING USED FOR WEEKLY SAMPLES:

MINIMUM TESTING FREQUENCY FOR WEEKLY SAMPLES: PER WEEK

POINT OF SAMPLING: SILO TANKER OTHER:

IV. LABORATORY FOR (MONTHLY) TESTING - ASTM C618

NAME:

ADDRESS (STREET OR PO BOX):

CITY: STATE: ZIP CODE:

CONTACT PERSON:

PHONE NUMBER:

IS LABORATORY CCRL ACCREDITED? YES NO

MINIMUM TESTING FREQUENCY FOR MONTHLY SAMPLES: PER MONTH

POINT OF SAMPLING: SILO TANKER OTHER:

V. OTHER COMMENTS:

NOTE: WHEN ANY CHANGES IN THE ABOVE INFORMATION OCCURS, THE DIVISION OF MATERIALS MUST BE NOTIFIED IN WRITING.

SIGNED (DISTRIBUTOR OFFICIAL):

DATE:

10-FOOT ROLLING STRAIGHT EDGE TEST

1. **SCOPE:** This method covers the procedure for conducting a 10-foot rolling straight edge test on bridge decks, including overlays, and concrete pavement where ride quality requirements do not apply. The purpose of the test is to determine areas that fail to meet the 1/8 inch tolerance outlined in section 501, 606 and 609 of the Standard Specifications
2. **APPARATUS: 10-Foot Rolling Straight Edge:** Rolling straight edge that has three adjustable rods spaced every 2.5 feet along the device. The rods shall be adjustable to provide a 1/8 inch clearance in a straight line between the bottom of the rods and the bottom of the wheels.
3. **PROCEDURE:**
 - 3.1 A 10-foot rolling straight edge test is required on all new bridge decks, bridge deck overlays, and all concrete pavement where ride quality requirements do not apply.
 - 3.2 Department personnel should test the deck as soon as the deck has cured and has been cleared of all debris.
 - 3.3 Department personnel should begin testing concrete pavement as soon as the concrete has hardened sufficiently to support walking.
 - 3.4 Place rolling straight edge in the wheel path of all lanes, including turning lanes. The exceptions to this testing are at single point urban interchanges where the turning lanes cross the crown of the bridge deck and at intersections when designed differently by the concrete intersection's pavement elevation detail sheet.
 - 3.5 Adjust the rods to provide a 1/8 inch clearance in a straight line between the bottom of the rods and the bottoms of the wheels.
 - 3.6 For bridge decks, roll the device along the entire length of the deck in the wheel path of each lane between the armored edges of the bridge ends. For concrete pavements, roll the device along the entire length of new concrete pavement in the wheel path of each lane.
 - 3.7 If the device encounters a spot greater than 1/8 inch, it will scrape the bridge deck until it clears the "high spot" in the deck. Mark the high spot in the deck.
4. **RESULTS:**
 - 4.1 All high spots marked on the deck should be corrected to provide the required 1/8 inch variance allowed by specifications.
 - 4.2 The Contractor should propose a method for correcting the high spots found during the straight edge test.

4.3 The proposed method of correction must be approved by the Engineer prior to the start of any corrective action.

APPROVED Allen H. Myers
DIRECTOR
DIVISION OF MATERIALS

DATE 06/11/12

Kentucky Method 64-326-12
Dated 06/11/12

CALIBRATING AND CHECKING COLD-FEED FLOW ON ASPHALT MIXING PLANTS

1. SCOPE:
 - 1.1. This test method describes the procedure for calibrating the cold-feed flow from the cold-aggregate storage bins at an asphalt mixing plant. Use this procedure when determining the percentage of polish-resistant aggregate in various wearing course applications.
 - 1.2. Samples obtained from this procedure may be retained for other testing purposes (insoluble residue, percentage of crushed faces, magnesium carbonate, sand equivalent, etc.) as applicable.
2. APPARATUS:
 - 2.1. Provide platform scales with a minimum capacity of 10 kg and a minimum sensitivity of 1 percent. If platform scales are not available, use the standard balance normally found in the asphalt mixing plant laboratory.
 - 2.2. Provide buckets, pans, and/or other suitable containers sufficient to obtain the material from the entire cross-section of the aggregate flow.
3. SAMPLE: Obtain a representative sample from each cold feed as applicable.
4. PROCEDURE:
 - 4.1. Perform the calibration or check by obtaining samples from each cold feed as applicable, weighing each sample, and converting the sample weights to a percentage of the total aggregate weight. Since many types of cold feeds exist, develop a detailed procedure individually for each plant. However, essentially two general methods for checking the rate of flow from each feed exist.
 - 4.1.1 The preferred method is the “equal time” method; for this procedure, obtain a sample from each feed for the same amount of time. Since it is more indicative of normal plant operations, use the “equal time” method whenever possible.
 - 4.1.2 The second method is the “equal length” method; in this case, measure off the same length of flow of each aggregate from the cold-feed belt after stopping the flow. If “clumping” of the aggregate occurs when using the “equal length” method, spread the material from three to five “clumps” as evenly as possible along a length of the belt prior to obtaining the sample.
 - 4.2. Perform cold-feed checks with the plant in normal operation if possible. When necessary, however, cease plant operations to perform the checks twice daily. Also, cease plant operations if it is unsafe to check the cold feeds with the plant in operation. NEVER ATTEMPT TO TAKE SAMPLES WHEN THE PLANT IS OPERATING UNLESS IT IS

SAFE. When the plant flow is erratic, obtain more than one sample, and average the results, to achieve a more representative value.

4.3. The Department may accept plants that have digital cold-feed displays, showing the percentage of aggregate from each cold feed, by display only. In these cases, the Department will require a comparison of physical checks versus the display prior to acceptance by display only. Perform periodic verification of this comparison.

5. EXAMPLE CALCULATION: The mixture in question is a CL4 ASPH SURF 0.50A PG76-22. According to Subsection 403.03.03 of the [Standard Specifications](#), this mixture requires that 100 percent of the coarse aggregate be from Class A polish-resistant sources and that 20 percent of the total combined aggregate be Class A polish-resistant fine aggregate.

5.1. Sample each aggregate used in the mix, and convert the sample weights to a percentage of the total.

Dolomite # 8's	4390	g of polish-resistant coarse aggregate (PRC)
Crush. Grav. Sand	2000	g of polish-resistant fine aggregate (PRF)
<u>Limestone Sand</u>	<u>4570</u>	<u>g</u>
TOTAL	10,960	g

The only coarse aggregate in the mixture is the Class A dolomite #8's. Therefore, the PRC requirement is satisfied, and it only remains to check the PRF. Calculate the PRF as follows:

$$PRF = \frac{2000}{10,960} = 18.2\%$$

Therefore, the percentage of Class A polish-resistant fine aggregate is 18 percent.

5.2. In this example, an appropriate reaction to these results would be to increase the feed for the crushed gravel sand to satisfy the 20 percent polish-resistant fine aggregate requirement. After performing this adjustment, check all the feeds again.

NOTE 1: Locate the allowable tolerances for individual aggregates in the applicable specification.

6. REPORT:

6.1. Record all values to the nearest whole number.

6.2. Record the results for all aggregate components on the *Asphalt Mixtures Acceptance Workbook (AMAW)*.

APPROVED

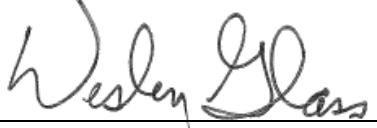

DIRECTOR
DIVISION OF MATERIALS

DATE

Kentucky Method 64-401-05
Revised 12/28/04
Supersedes KM 64-401-03
Dated 02/18/03

SAMPLING LIQUID ASPHALT MATERIALS

1. SCOPE:
 - 1.1. This method applies to the sampling of liquid asphalt materials at the point of manufacture or the destination from bulk storage tanks, barges, rail cars, truck transports, and distributors.
 - 1.2. Since sampling is as important as testing, make every effort to obtain samples which are truly representative of the material sampled.
2. SAMPLE SIZE:
 - 2.1. Provide minimum sample sizes for liquid asphalt materials as follows:
 - 2.1.1. Performance-graded (PG) binders; two 1-quart samples.
 - 2.1.2. Emulsified asphalts, "Primer L", KP-2, KP-4, and KP-6; two 1-gallon samples.
3. CONTAINERS:
 - 3.1. Types of containers
 - 3.1.1. For PG binders, KP-2, and KP-6, provide wide-mouth, friction-top cans or square or round cans with screw-lined tops.
 - 3.1.2. For cationic and anionic emulsified asphalts, KP-4, and "Primer L", provide small-mouth, polyethylene jugs or bottles.
 - 3.2. Size of containers: Provide containers of a size corresponding to the required amount of the sample.
 - 3.3. Physical condition of containers: Provide new sample containers. Do not use containers which exhibit evidence of solder flux or any other foreign matter or are not clean and dry. Also, do not use containers which have been washed, rinsed, or contain oily residue.
4. SAMPLING VALVES:
 - 4.1. Storage and shipping tanks: Ensure each tank has a sampling valve similar in design to either of the valves shown by Figure 2 in AASHTO T 40-02.
 - 4.2. Tank cars, transports, and distributors: Ensure each delivery vehicle is equipped with a sampling valve similar in design to that shown by Figure 4 in AASHTO T 40-02.

5. SAMPLING LIQUID ASPHALT MATERIALS:

- 5.1. Sampling from an approved valve: Drain at least one gallon of material through the sampling valve prior to obtaining a sample in order to purge the valve of any foreign material. Allow the material to slowly drain from the tank into a clean container of the type and size previously specified.
- 5.2. Sampling directly from a line: Obtain samples from loading lines, unloading lines, or circulating lines serving a tank, providing the sample is taken from an approved sampling valve. Do not take samples from the main unloading valve or the end of the discharge hose. It is desirable that the sampling valve be constructed and located so the sample may be taken while material is being pumped. When sampling from the unloading line of a carrier tank, allow sufficient material to unload before taking the sample to purge the line of the previous material. If possible, obtain the sample during the unloading of the middle one-third of the load. The sampling valve should be purged before taking the sample by running a minimum of one gallon of material through the valve. If possible, draw the sample slowly while the material is flowing to represent as much of the tank as possible. When the pump must be stopped to obtain the sample, draw one sample at approximately the one-third point, and draw the check sample at approximately the two-thirds point, of unloading.
- 5.3. Sampling from a spray bar or hand wand: Obtain samples from the spray bar or hand wand of a distributor only when an approved sampling valve is not available. Spray at least one gallon of material through the spray-bar nozzle or hand wand prior to obtaining a sample. Spray the material into a clean container of the type and size previously specified.

6. NUMBER OF SAMPLES REQUIRED FOR LIQUID ASPHALT MATERIALS:

- 6.1. Source of sampling: When the sampling takes place at the refinery or terminal for source certification, obtain one sample, and submit it to the testing laboratory.
- 6.2. Field or destination: Obtain two samples for project certification. Obtain emulsion samples from the distributor and PG binder samples from the contractor's storage tank or transport tanker. For either type of material, submit both samples to the laboratory for testing.

7. CARE OF LIQUID ASPHALT MATERIAL AFTER SAMPLING:

- 7.1. Immediately seal containers after sampling to avoid possible sample contamination.
- 7.2. Do not use water or any solvent (gasoline, diesel fuel, etc.) to aid in the cooling or cleaning of the container. If cleaning is necessary, use a clean, dry cloth.

8. SAMPLE IDENTIFICATION AND SHIPMENT: Properly identify all samples by completely filling in the appropriate label and attaching it to the container. Carry or ship samples in cartons to the Division of Materials, Frankfort, Kentucky. Pack samples to provide protection during transit. Protect emulsion samples from freezing, and carry them (not ship them) to the laboratory during freezing weather.

9. GENERAL: Measurement of tank quantity: Record the quantity which the sample represents on the sample identification form. Obtain this quantity from a tank gauge or shipping ticket, if considered accurate. Otherwise, calculate the quantity from the tank measurement reported at 60°F. The “outage” measurement method as described in the attachment is usually the best method.

APPROVED



DIRECTOR
DIVISION OF MATERIALS

DATE

12/28/04

Kentucky Method 64-404-05
Revised 12/28/04
Supersedes KM 64-404-03
Dated 1/8/03

Attachments

ATTACHMENT
TABLE 1
QUANTITIES FOR VARIOUS DEPTHS OF
CYLINDRICAL TANKS IN A HORIZONTAL POSITION

% DEPTH FILLED	% OF CAPACITY	% DEPTH FILLED	% OF CAPACITY	% DEPTH FILLED	% OF CAPACITY	% DEPTH FILLED	% OF CAPACITY
1	0.20	26	20.73	51	51.27	76	81.50
2	0.50	27	21.86	52	52.55	77	82.60
3	0.90	28	23.00	53	53.81	78	83.68
4	1.34	29	24.07	54	55.08	79	84.74
5	1.87	30	25.31	55	56.34	80	85.77
6	2.45	31	26.48	56	57.60	81	86.77
7	3.07	32	27.66	57	58.86	82	87.76
8	3.74	33	28.84	58	60.11	83	88.73
9	4.45	34	30.03	59	61.36	84	89.68
10	5.20	35	31.19	60	62.61	85	90.60
11	5.98	36	32.44	61	63.86	86	91.50
12	6.80	37	33.66	62	65.10	87	92.36
13	7.64	38	34.90	63	66.34	88	93.20
14	8.50	39	36.14	64	67.56	89	94.02
15	9.40	40	37.39	65	68.81	90	94.80
16	10.32	41	38.64	66	69.97	91	95.55
17	11.27	42	39.89	67	71.16	92	96.26
18	12.24	43	41.14	68	72.34	93	96.93
19	13.23	44	42.40	69	73.52	94	97.55
20	14.23	45	43.66	70	74.69	95	98.13
21	15.26	46	44.92	71	75.93	96	98.66
22	16.32	47	46.19	72	77.00	97	99.10
23	17.40	48	47.45	73	78.14	98	99.50
24	18.50	49	48.73	74	79.27	99	99.80
25	19.61	50	50.00	75	80.39		

$$\text{Capacity of Tank (in gals)} = \frac{0.7854 \times D^2 \times L}{231}$$

where: D = the diameter of the interior of the tank in inches; and
L = the length of the interior of the tank in inches.

NOTE: The volume occupied by any piping, fittings, or other material inside the tank must be deducted from the volume determined from the table.

=EXAMPLE=

- (1) Outage (unfilled) measurement = 6'7" = 79"
Diameter of the tank = 8'4" = 100"
Length of the tank = 15'0" = 180"
Interior piping = 30' of 3" pipe, all submerged
Temperature of PG binder = 290 °F
- (2) Gross capacity of the tank = $\frac{0.7854 \times (100)^2 \times 180}{231}$ = 6120 gallons
Displacement volume of the interior piping = $\frac{0.7854 \times (3)^2 \times (30 \times 12)}{231}$ = 11 gallons
- (3) % depth filled = $\frac{(\text{Diameter} - \text{Outage})}{\text{Diameter}} \times 100 =$
 $\frac{(100-79)}{100} \times 100 = 21\%$,
so from Table 1, % of capacity = 15.26.
- (4) Quantity of materials = (0.1526 x 6120) - 11 = 923 gal. @ 290 °F.
- (5) Quantity of materials @ 60 °F
Temperature correction factor from Table 2 = 0.922 for 290 °F.
Quantity @ 60 °F = 0.922 x 923 gallons = 851 gallons.
- (6) When material quantities need to be expressed in pounds mass, multiply the calculated gallons by the appropriate weight per gallon listed below.

(a)	PG 64-22	8.48
	PG 76-22	8.68
(b)	“Primer L”	7.67
(c)	Emulsions	8.31

FACTORS FOR CORRECTING SPECIFIC GRAVITIES OF ASPHALT BINDERS AND CUTBACKS TO
OPERATING TEMPERATURE
(TEMPERATURES ARE IN °F)

40 = 1.0070	90 = 0.9896	140 = 0.9723	190 = 0.9553	240 = 0.9385	290 = 0.9220
41 = 1.0067	91 = 0.9892	141 = 0.9720	191 = 0.9550	241 = 0.9382	291 = 0.9217
42 = 1.0063	92 = 0.9889	142 = 0.9716	192 = 0.9547	242 = 0.9379	292 = 0.9213
43 = 1.0060	93 = 0.9885	143 = 0.9713	193 = 0.9543	243 = 0.9375	293 = 0.9210
44 = 1.0056	94 = 0.9882	144 = 0.9710	194 = 0.9540	244 = 0.9372	294 = 0.9207
45 = 1.0053	95 = 0.9878	145 = 0.9706	195 = 0.9536	245 = 0.9369	295 = 0.9204
46 = 1.0049	96 = 0.9875	146 = 0.9703	196 = 0.9533	246 = 0.9365	296 = 0.9200
47 = 1.0046	97 = 0.9871	147 = 0.9699	197 = 0.9530	247 = 0.9362	297 = 0.9197
48 = 1.0042	98 = 0.9868	148 = 0.9696	198 = 0.9526	248 = 0.9359	298 = 0.9194
49 = 1.0038	99 = 0.9864	149 = 0.9693	199 = 0.9523	249 = 0.9356	299 = 0.9190
50 = 1.0035	100 = 0.9861	150 = 0.9689	200 = 0.9520	250 = 0.9352	300 = 0.9187
51 = 1.0031	101 = 0.9857	151 = 0.9686	201 = 0.9516	251 = 0.9349	301 = 0.9184
52 = 1.0028	102 = 0.9854	152 = 0.9682	202 = 0.9513	252 = 0.9346	302 = 0.9181
53 = 1.0024	103 = 0.9851	153 = 0.9679	203 = 0.9509	253 = 0.9342	303 = 0.9177
54 = 1.0021	104 = 0.9847	154 = 0.9675	204 = 0.9506	254 = 0.9339	304 = 0.9174
55 = 1.0017	105 = 0.9844	155 = 0.9672	205 = 0.9503	255 = 0.9336	305 = 0.9171
56 = 1.0014	106 = 0.9840	156 = 0.9669	206 = 0.9499	256 = 0.9332	306 = 0.9167
57 = 1.0010	107 = 0.9837	157 = 0.9665	207 = 0.9496	257 = 0.9329	307 = 0.9164
58 = 1.0007	108 = 0.9833	158 = 0.9662	208 = 0.9493	258 = 0.9326	308 = 0.9161
59 = 1.0003	109 = 0.9830	159 = 0.9658	209 = 0.9489	259 = 0.9322	309 = 0.9158
60 = 1.0000	110 = 0.9826	160 = 0.9655	210 = 0.9486	260 = 0.9319	310 = 0.9154
61 = 0.9997	111 = 0.9823	161 = 0.9652	211 = 0.9483	261 = 0.9316	311 = 0.9151
62 = 0.9993	112 = 0.9819	162 = 0.9648	212 = 0.9479	262 = 0.9312	312 = 0.9148
63 = 0.9990	113 = 0.9816	163 = 0.9645	213 = 0.9476	263 = 0.9309	313 = 0.9145
64 = 0.9986	114 = 0.9813	164 = 0.9641	214 = 0.9472	264 = 0.9306	314 = 0.9141
65 = 0.9983	115 = 0.9809	165 = 0.9638	215 = 0.9469	265 = 0.9302	315 = 0.9138
66 = 0.9979	116 = 0.9806	166 = 0.9635	216 = 0.9466	266 = 0.9299	316 = 0.9135
67 = 0.9976	117 = 0.9802	167 = 0.9631	217 = 0.9462	267 = 0.9296	317 = 0.9132
68 = 0.9972	118 = 0.9799	168 = 0.9628	218 = 0.9459	268 = 0.9293	318 = 0.9128
69 = 0.9969	119 = 0.9795	169 = 0.9624	219 = 0.9456	269 = 0.9289	319 = 0.9125
70 = 0.9965	120 = 0.9792	170 = 0.9621	220 = 0.9452	270 = 0.9286	320 = 0.9122
71 = 0.9962	121 = 0.9788	171 = 0.9618	221 = 0.9449	271 = 0.9283	321 = 0.9118
72 = 0.9958	122 = 0.9785	172 = 0.9614	222 = 0.9446	272 = 0.9279	322 = 0.9115
73 = 0.9955	123 = 0.9782	173 = 0.9611	223 = 0.9442	273 = 0.9276	323 = 0.9112
74 = 0.9951	124 = 0.9778	174 = 0.9607	224 = 0.9439	274 = 0.9273	324 = 0.9109
75 = 0.9948	125 = 0.9775	175 = 0.9604	225 = 0.9436	275 = 0.9269	325 = 0.9105
76 = 0.9944	126 = 0.9771	176 = 0.9601	226 = 0.9432	276 = 0.9266	
77 = 0.9941	127 = 0.9768	177 = 0.9597	227 = 0.9429	277 = 0.9263	<u>PROCEDURE</u>
78 = 0.9937	128 = 0.9764	178 = 0.9594	228 = 0.9426	278 = 0.9259	Multiply the
79 = 0.9934	129 = 0.9761	179 = 0.9590	229 = 0.9422	279 = 0.9256	specific gravity
80 = 0.9930	130 = 0.9758	180 = 0.9587	230 = 0.9419	280 = 0.9253	of the asphalt
81 = 0.9927	131 = 0.9754	181 = 0.9584	231 = 0.9416	281 = 0.9250	material at 60 °F
82 = 0.9923	132 = 0.9751	182 = 0.9580	232 = 0.9412	282 = 0.9246	times the factor
83 = 0.9920	133 = 0.9747	183 = 0.9577	233 = 0.9409	283 = 0.9243	corresponding to
84 = 0.9916	134 = 0.9744	184 = 0.9574	234 = 0.9405	284 = 0.9240	the operating
85 = 0.9913	135 = 0.9740	185 = 0.9570	235 = 0.9402	285 = 0.9236	temperature.
86 = 0.9909	136 = 0.9737	186 = 0.9567	236 = 0.9399	286 = 0.9233	
87 = 0.9906	137 = 0.9734	187 = 0.9563	237 = 0.9395	287 = 0.9230	
88 = 0.9902	138 = 0.9730	188 = 0.9560	238 = 0.9392	288 = 0.9227	
89 = 0.9899	139 = 0.9727	189 = 0.9557	239 = 0.9389	289 = 0.9223	

Temperatures below 225 °F are for cutbacks, and temperatures at or above 225 °F are for asphalt binders.

EXTRACTION OF BINDER FROM ASPHALT PAVING MIXTURES

1. SCOPE: This test method covers the determination of the asphalt binder content (AC) of asphalt mixtures by use of a centrifuge extractor (Method A) or a vacuum extractor (Method B).

2. SIGNIFICANCE AND USE:

2.1. This method is one of a group of approved means of determining the AC of asphalt mixtures. Other means include [Kentucky Method \(KM\) 64-436](#), *Asphalt Binder Content Determination of Asphalt Mixtures by Plant Recordation*, [KM 64-437](#), *Determination of Asphalt Binder Content of Asphalt Mixtures Using the Nuclear Asphalt Content Gauge*, [KM 64-438](#), *Asphalt Binder Content Determination of Asphalt Mixtures Based on the Maximum Specific Gravity*, or AASHTO T 308, *Determining the Asphalt Binder Content of Hot-Mix Asphalt (HMA) by the Ignition Method*.

2.2. Use this method for process-control or acceptance testing. The Department of Highways will use this method for informational testing.

NOTE 1: Utilize the solvent of choice. However, this method does not purport to address any safety or disposal considerations associated with its use. Determine and implement appropriate safety and health practices, handling and storage procedures, disposal limitations, and comply with any applicable regulatory limits prior to use.

Ensure the solvent is effective in removing all asphalt binder from the aggregate. When testing the extracted aggregate further, ensure the solvent leaves the sample “film-free” after water rinsing, if applicable.

CAUTION: Ascertain the suitability of the solvent for use in the particular type of extractor available. Some solvents may not be suitable in all types of extractors.

2.3. Use AASHTO T 164, *Quantitative Extraction of Bitumen from Bituminous Paving Mixtures*, Method A or B, when performing “referee” testing or dispute resolution.

3. SAFETY PRECAUTIONS:

3.1. All solvents are potentially toxic and/or hazardous; use these materials under an exhaust hood and/or in an area with adequate ventilation. Avoid inhaling the vapors and skin contact. If skin contact occurs, rinse with soap and water. For vacuum extractors, vent the exhaust from the vacuum pump outside, and drain the vacuum extractor daily. Avoid open flames or any other potential source of ignition.

NOTE 2: Some possibility of spontaneous combustion exists when using “biodegradable” or organic solvents. Handle and store the solvent according to the directions specified on

the materials safety data sheet (MSDS). Strictly observe any precautions or handling practices indicated by the manufacturer. Properly dispose of any cleaning items, such as rags.

3.2. Use the following operator safety equipment: eye protection, apron, and gloves.

4. APPARATUS:

4.1. Provide a ventilation system, capable of removing fumes and dust, conforming to Section 401 of the *Standard Specifications for Road and Bridge Construction*.

4.2. Provide scales capable of weighing 5,000 g to an accuracy of 1.0 g.

4.3. Provide an extraction solvent.

4.4. Provide an ultrasonic cleaner and insert tray or bowl (optional).

4.5. Provide a hot plate or oven.

4.6. Provide water (if applicable).

4.7. Provide a propane burner (optional).

NOTE 3: Consider Methods A and B, without dust-loss corrections, to be rapid, field-test methods only. Before using either method, determine that the procedure is satisfactory by comparing the results to a “referee” method (such as AASHTO T 164). See [Subsection 8.4](#) for the procedure for determining dust loss through the vacuum extractor (Method B).

4.8. For the centrifuge method (Method A) only:

4.8.1. Provide a centrifuge in which the bowl may be revolved at controlled, variable speeds up to 3600 revolutions per minute (rpm).

4.8.2. Provide a filter-ring pad (capable of retaining aggregate particles larger than 6 microns), medium grade.

4.8.3. Provide the necessary miscellaneous equipment, such as a measuring cup or can, scoop with a rectangular cross-section, thermometer, spatula, brushes, large drying pans, etc.

4.9. For the vacuum-extractor method (Method B) only:

4.9.1. Provide a vacuum extractor and vacuum pump, assembled as shown in [Figure 1](#).

4.9.2. Provide a watch glass.

4.9.3. Provide filter paper (capable of retaining aggregate particles larger than 6 microns), 13-in. diameter, medium grade.

- 4.9.4. Provide a filtering aid (Celite). Ensure that all of the material is finer than a No. 200 sieve, or else determine and apply a correction.
- 4.9.5. Provide the necessary miscellaneous equipment, such as a bowl, spoons, thermometer, putty knife, drying pan, wash bottle, propane burner (optional), etc.
5. SAMPLES: Refer to [KM 64-425](#), *Sampling Asphalt Mixtures*, for procedures for obtaining and reducing samples to the required test-portion size.
6. GENERAL PROCEDURE (Centrifuge - Method A):
 - 6.1. Check the scales to ensure its preparedness for use (zeroed, balanced, etc.).
 - 6.2. Inspect the centrifuge bowl for warping. If the bowl is acceptable, record the tare weight of the empty and clean centrifuge bowl as W_1 . Weigh, and record the weight of, the filter pad(s).

NOTE 4: The scale may be zeroed (tared) with the bowl on the scale. In this case, add the test portion to the bowl, and record the weight as W_2 .
 - 6.3. Weigh the required test portion into the bowl, and record the total weight of the test portion and bowl as W_2 .
 - 6.4. Allow the sample to cool. Pour enough solvent into the bowl to cover the mixture. Allow the solvent-covered sample to soak for a minimum of 20 minutes, while stirring or agitating occasionally.
 - 6.5. Place the bowl containing the sample and solvent into the centrifuge.
 - 6.6. Place the filter pad(s) on top of the bowl so that the pad(s) extend(s) past the rim of the bowl for its entire circumference. Place the smoothest, tightest side of the filter down, facing the bowl. Place the lid on the bowl, and tighten it enough to secure the filter pad(s) in place.
 - 6.7. Complete the tightening of the bowl lid by hand until it is adequately sealed. A tight seal is important as it minimizes the loss of the finer fractions of the aggregate. Do not tighten the lid with a wrench; this practice may cause warping of the lid.
 - 6.8. Revolve the centrifuge slowly at first; then, increase the speed to a maximum of 3600 rpm. Continue this operation until solvent ceases to flow from the centrifuge drain. Collect the effluent, and allow the aggregate particles to settle. For visual inspection of dust loss, use a “see-through” container to collect the effluent. When desired, perform a visual inspection to obtain an approximate degree of dust loss. Retain the effluent from each wash for determining the amount of dust loss ([see Note 3](#)). Repeat the adding of solvent and washing until the extracted solvent is a light “straw” color. Normally, use no more than five cycles. For those mixtures from which the asphalt is difficult to extract (such as mixtures with high absorption, high asphalt contents, special additives or materials, etc.), an ultrasonic cleaner may be used to aid in the removal of the asphalt prior to placing the solvent/asphalt solution into the centrifuge for extraction.

If using an ultrasonic cleaner, determine the sample weight prior to placing the solvent into the ultrasonic cleaner. Pour cold water in the ultrasonic cleaner, and place the insert tray with the sample in the ultrasonic cleaner. If the tray floats, remove some of the water. Add sufficient solvent to just cover the sample. Turn on the ultrasonic cleaner to break the sample apart and dissolve the asphalt.

- 6.9. When using biodegradable/organic solvent, rinse the solvent film from the aggregate prior to drying the aggregate (when the manufacturer's recommendations so specify). If so, add enough clear water to cover the sample, and wash the solvent "film" completely from the aggregate. Repeat the adding of water and washing until the sample has been thoroughly washed. Again, normally use no more than five cycles. Allow the last wash to spin longer than the preceding ones, removing as much of the water as possible, thus expediting the drying of the aggregate.

NOTE 5: When not using a biodegradable/organic solvent to extract the asphalt from the mixture, do not perform the procedure given in Subsection 6.9 prior to drying the aggregate.

- 6.10. After the final wash, disengage the bowl; loosen the lid, and remove and clean the filter pad(s) by scraping and brushing the loose aggregate particles into a separate drying container. Remove the remaining aggregate particles from the centrifuge bowl, and place the particles into the drying container. Ensure no aggregate is lost while performing the test.
- 6.11. Remove all solvent and moisture from the sample prior to the final weighing. Depending on the type of solvent utilized, accomplish this process by heating the sample in an oven or on a hot plate with adequate ventilation. Determine the weight gain from the filter pad(s) by weighing the dried pad(s) and subtracting the original weight of the pad(s) from the dried weight. Record the "pad gain" as W_3 .

NOTE 6: Adequately vent solvent fumes from the drying process outside the laboratory.

- 6.12. Weigh the extracted aggregate; record this weight as W_4 .
- 6.13. When determining the gradation of the aggregate according to [KM 64-433](#), *Wet-Sieve Analysis of Aggregates Used in Asphalt Mixtures*, retain the dried aggregate.

7. CALCULATIONS AND REPORT (Centrifuge - Method A):

- 7.1. Calculate the % AC by the following formula:

$$\% AC = \frac{(W_2 - W_1) - (W_3 + W_4)}{W_2 - W_1}, \text{ where}$$

W_1 = Tare weight of the bowl (g) if applicable;

W_2 = Weight of the coated sample and the bowl (g);

W_3 = Pad(s) weight gain (g); and

W_4 = Weight of the extracted dry aggregate (g).

7.2. When performing acceptance testing, report the % AC to the nearest 0.1 percent on the appropriate *Asphalt Mixtures Acceptance Workbook (AMAW)*.

8. GENERAL PROCEDURE (Vacuum Extractor - Method B):

NOTE 7: Equipment modification as described in [Note 9](#) will likely be required. It is strongly recommended that a vacuum-extractor bypass be attached to allow the filtrate to be collected in separate vacuum flasks. This type of bypass permits the solvent washes to remain totally separate from the water washes (if utilizing a solvent in which the water rinses are necessary). Gel formation can occur when water contacts some biodegradable/organic solvents in particular concentration ranges. This gel, if formed, can clog filter pads and cause fouling of the equipment, as well as causing disposal difficulties. AASHTO T 164 provides a detailed sketch of a typical vacuum extractor apparatus.

8.1. Record the weight of the insert tray or bowl used to wash the sample. Place the required test portion in the bowl or insert tray, and record the weight of the bowl or insert tray plus the test portion.

NOTE 8: The scale may be zeroed (tared) with the insert tray or bowl on the scale. In this case, add the test portion to the insert tray or bowl, and record the weight.

8.2. Place a dry filter of known weight on the vacuum extractor, taking care to center the filter on the funnel wing, and tighten the wing-nuts “finger tight.”

8.3. Weigh 50 g of filtering aid ([Celite](#)) in a quart container. Add approximately 500 ml of solvent. Stir to form a slurry. Pour the slurry over the filter paper, washing the quart container and spoon to ensure that all the filtering aid is transferred to the filter paper. Vacuum off the solvent until the filtering aid dries and the surface cracks. When experience indicates the mixture is “fast-filtering,” do not use the filtering aid.

8.4. Allow the sample to cool. Add sufficient solvent to just cover the sample. Stir the sample to break it up and dissolve the asphalt. If an ultrasonic cleaner is being used, pour cold water in the ultrasonic cleaner, and place the insert tray with the sample in the ultrasonic cleaner. If the tray floats, remove some of the water. Add sufficient solvent to just cover the sample. Turn on the ultrasonic cleaner to break up the sample and aid in the removal of the asphalt. Allow the sample to soak as described in [Subsection 6.8](#).

NOTE 9: If it is desired to inspect the effluent for dust loss, bypass the vacuum-extractor collection tank, and catch the solvent/asphalt/aggregate fines mixture in a glass flask for viewing or dust-loss determination ([see Note 3](#)).

8.5. Place the watch glass on the filtering-aid surface. Pour the solvent/asphalt solution onto the watch glass carefully so as not to damage the filtering-aid surface. Start the vacuum pump to draw off the solvent/asphalt solution. Apply vacuum until the liquid has been drawn off. Add additional solvent, and repeat this process until the aggregate has been

washed clean of asphalt. Pour the solution directly on the filter without using the watch glass when the filtering aid is not used. After the last solvent wash, replace the flask that has been used to collect the solvent washes, and attach a clean flask for collection of the “water washes.”

- 8.6. When biodegradable/organic solvent is utilized, check the manufacturer’s recommendation regarding rinsing the solvent film from the aggregate prior to drying. If recommended, add enough water to cover the sample and stir well. The water will turn “milky-white” at this point. After completely stirring, pour the water onto the watch glass, and vacuum the water through the filter. Repeat the “water washes” until the water is clear (approximately four washes).
- 8.7. After pouring off the last “water wash,” lift the watch glass from the filter. Carefully clean the watch glass by washing the filtering aid and aggregate onto the filter.

NOTE 10: When not using a biodegradable/organic solvent to extract the asphalt from the mixture, ignore the instructions given in Subsections 8.6 and 8.7 prior to drying the aggregate.

- 8.8. Transfer the cleaned aggregate to the vacuum extractor.
- 8.9. Spread the cleaned aggregate over the filter paper. Cover the aggregate with water for a final wash. Vacuum off the water. Move the aggregate and filtering aid away from the sides of the vacuum extractor.
- 8.10. Record the weight of the drying pan. Disassemble the vacuum extractor, and place the aggregate and filtering aid, if used, in the drying pan. Clean the fines from the filter paper into the drying pan, and then place the filter paper in the drying pan.
- 8.11. Dry the aggregate, any filtering aid, and filter in an oven or on a hot plate. Weigh, and record the total weight of, the drying pan, dried aggregate, and filter paper (and filtering aid if used).
- 8.12. If the gradation of the aggregate is to be determined according to [KM 64-433](#), retain the dried aggregate.

9. CALCULATIONS AND REPORT (Vacuum Extractor - Method B):

- 9.1. Determine the total weight of the test portion by subtracting the weight of the insert tray or bowl from the total weight of the insert tray plus the test portion or bowl plus the test portion, as applicable. See [Subsection 8.1](#).
- 9.2. Determine the total weight of the dried aggregate by subtracting the weight of the drying pan plus the original weight of the filter paper plus 50 g of filtering aid (when used) from the gross weight as determined in Subsection 8.11.

9.3. Calculate the % AC by the following formula:

$$\% AC = 100 \left(\frac{\text{Total Weight of Test Portion} - \text{Weight of Dry Aggregate}}{\text{Total Weight of Test Portion}} \right)$$

9.4. See the [attached worksheet](#) for determining the % AC with or without filtering aid.

9.5. When performing acceptance testing, report the % AC to the nearest 0.1 percent on the [appropriate AMAW](#).

10. DISTRICT OR DIVISION OF MATERIALS TESTING:

10.1. The Department will perform testing in either the District laboratory or the Division of Materials, for informational purposes, dispute resolution, etc., from either recently produced mixture or pavement cores, according to Subsections 3-9 (with the following exceptions):

10.2. The sample will require heating in order to obtain a test portion. Heat the sample as necessary to separate it with a spatula or trowel (so that the asphalt can be adequately removed). Do not overheat the sample such as to cause the asphalt to drain from the aggregate. When pavement samples are tested, thoroughly heat the sample in an oven at 230 ± 9 °F. After heating the sample, break down the material, and thoroughly blend the heated sample prior to obtaining a test portion.

11. EXTRACTOR CAPACITY: Ensure the size of the test portions fully complies with the provisions of [KM 64-425](#).

12. DUST LOSS CORRECTION: When either experience or testing identifies a significant dust loss from the extractor, additional equipment and testing may be required as described in AASHTO T 164.

APPROVED



DIRECTOR
DIVISION OF MATERIALS

DATE

12/28/04

Kentucky Method 64-405-05

Revised 12/28/04

Supersedes KM 64-405-04

Dated 03/04/04

Attachments

CALCULATION WORKSHEET

ASPHALT CONTENT DETERMINATION BY VACUUM EXTRACTION

With Filtering Aid

Weight of insert tray or bowl plus sample (g) _____

Weight of insert tray or bowl (g) _____

Weight of sample (g) _____

Weight of drying pan and 50 g of filtering aid,
dried aggregate, and dried filter pad (g) _____

Weight of drying pan and 50 g of filtering aid,
plus original weight of filter pad (g) _____

Weight of dried aggregate (g) _____

Asphalt content (%) = $\frac{100 * (\text{Weight of sample} - \text{Weight of dried aggregate})}{\text{Weight of sample}}$ = _____

Without Filtering Aid

Weight of insert tray or bowl plus sample (g) _____

Weight of insert tray or bowl (g) _____

Weight of sample (g) _____

Weight of drying pan, dried aggregate, and
dried filter pad (g) = _____

Weight of drying pan plus original weight
of filter pad (g) = _____

Weight of dried aggregate (g) _____

Asphalt content (%) = $\frac{100 * (\text{Weight of sample} - \text{Weight of dried aggregate})}{\text{Weight of sample}}$ = _____

CALCULATION WORKSHEET

ASPHALT CONTENT DETERMINATION BY VACUUM EXTRACTION AND ACCOMPANYING EXTRACTED GRADATION

Extracted Gradation

Sieve Size	Grams Retained	Percent Retained	Percent Passing
2 in.			
1 1/2 in.			
1 in.			
3/4 in.			
1/2 in.			
3/8 in.			
No. 4			
No. 8			
No. 16			
No. 30			
No. 50			
No. 100			
No. 200			
Pan			
Total			

SIEVE ANALYSIS OF AGGREGATE FROM ASPHALT MIXING PLANTS

1. SCOPE: This test method describes the procedure for the sieve analysis of aggregate obtained from the hot bins or collector belt of an asphalt mixing plant for informational, process-control, acceptance, or verification testing.
2. EQUIPMENT:
 - 2.1. Balance: Provide a balance or scales having a minimum capacity of 5000 g and a sensitivity of 1 g.
 - 2.2. Sieves: Provide sieves conforming to AASHTO M 92, *Wire-Cloth Sieves for Testing Purposes*.
 - 2.3. Miscellaneous equipment: Provide equipment suitable for sampling, handling, and storing the aggregate (buckets, pans, scoops, small brushes, etc.).
 - 2.4. Sampling devices: Provide a sampling device of adequate size to catch the entire flow of material from the hot-bin openings. When belt samples are utilized, provide suitable templates.

NOTE 1: It shall be the responsibility of the Contractor to furnish personnel to obtain aggregate samples.
3. REPRESENTATIVE SAMPLE: Obtain a sample that is representative of all the aggregate used in the mix. When mineral filler is used, include it in the sieve analysis. Account for collected dust, whether returned or wasted, in the sieve-analysis sample.
4. PROCEDURE:
 - 4.1. Sampling: For continuous-mix plants, sample at the apron feed leading to the pugmill. For batch plants, sample at the point that the material falls into the weigh hopper. For drum-mix plants, sample from the main collector belt or after the aggregate passes through the cold-feed bins. Construct and locate sampling facilities so that the samples can be safely obtained and will be representative of the aggregate incorporated into the mixture.
 - 4.2. Combining samples and testing: Obtain test-portion sizes conforming to Kentucky Method (KM) 64-425, *Sampling Asphalt Mixtures*.
 - 4.2.1. For hot-bin samples, proportionally combine the individual bin samples to the total weight required by Subsection 4.2 of this method.
 - 4.2.2. When using plant recordation for asphalt content acceptance, combine the individual bin samples to the ingredient percentages from the particular batch used for asphalt content determination purposes.

4.2.3. When not automatically recording the aggregate-proportioning information, combine the individual bin samples based on the available data. If the plant has a display screen but does not record the ingredient bin pulls or weights, use the displayed values (converted to percentages) that most nearly represent the material corresponding to the asphalt content determination sample to proportion the total sample. If the system does not display the ingredient bin pulls or weights on a screen or record them on a ticket, proportion the sample based on the theoretical (design) scale settings.

4.3. For drum-mix plants, obtain the aggregate sample as follows:

4.3.1. When sampling the aggregate from the belt of the drum-mix plant, choose a sampling location that provides access to the total, combined ingredient aggregate (after passing through the scalping screen).

4.3.2. When obtaining the individual aggregates after they pass through the cold-feed bins, proportion the composite sample according to the flow rates, displayed on the plant screen, that most nearly represent the material corresponding to the asphalt content determination sample. If the scalping screen removes significant quantities of oversize aggregate, adjust the sample to ensure that it is representative of the aggregate being incorporated into the mixture.

NOTE 2: FOR ALL TYPES OF PLANTS AND FOR ALL SAMPLING SITUATIONS, ENSURE THAT THE SAMPLE IS REPRESENTATIVE OF THE ACTUAL AGGREGATE USED IN THE MIX.

4.4. Corrections or adjustments may be necessary when:

4.4.1. scalping the material;

4.4.2. wasting the collected fines; or

4.4.3. including recycled-asphalt pavement (RAP).

4.5. An example of the calculations for proportioning the composite sample is as follows:

For a 0.38-in.-nominal mixture, obtain a 1500-g sample.

Bin percentages (or cold-feed rates):

Bin # 1 = 39% Bin # 2 = 40% Bin # 3 = 21%

Proportion the composite 1500-g sample as follows:

Bin #1 = 0.39 x 1500 = 585 g

Bin #2 = 0.40 x 1500 = 600 g

Bin #3 = 0.21 x 1500 = 315 g

1500 g

4.6. Thoroughly mix the individual aggregate samples, and remove representative portions from each bin or belt sample until obtaining the required weights.

5. TESTING PROCEDURES:

- 5.1. When preliminary testing to establish cold-feed or hot-bin settings or other informational testing is necessary, perform a dry-sieve analysis according to AASHTO T 27, *Sieve Analysis of Fine and Coarse Aggregates*.
- 5.2. When the sieve analysis is for acceptance purposes, perform the testing according to [KM 64-433](#), *Wet-Sieve Analysis of Aggregates Used in Asphalt Mixtures*, or [KM 64-620](#), *Wet Sieve Analysis of Fine and Coarse Aggregate*.

6. REPORT: Report the final gradation result on all sieves, except the No. 200, to the nearest whole number. Report the gradation of the No. 200 sieve to the nearest 0.5 percent. For example, report a result computed to be “3.2” as “3.0”, but report a result computed to be “3.3” as “3.5”.

APPROVED



DIRECTOR
DIVISION OF MATERIALS

DATE

02/21/08

Kentucky Method 64-407-08
Revised 02/21/08
Supersedes KM 64-407-03
Dated 01/09/03

COMPRESSION - DEFLECTION TEST FOR
PREFORMED COMPRESSION JOINT SEALS

1. SCOPE: This test procedure is for the determination of the compression-deflection resistance of preformed compression joint seals at 15 and 50- percent deflection.
2. APPARATUS -
 - 2.1. Compression-deflection apparatus - Provide a compression device consisting of two or more flat steel plates between the parallel faces of which the specimen may be compressed. Ensure that the plates between which the test specimen is compressed are made of steel of a sufficient thickness to withstand the applicable compressive stresses without bending. Ensure that the apparatus is capable of compressing a 4-in. length of preformed joint seal to 25 percent of its original width (the width of seals may vary from 0.25 in. to 5 in.) at a rate of 1.0 in. per minute. Ensure that the compression plates are large enough that the specimen does not deform beyond the sides or ends. Ensure that the applied load and specimen thickness can be determined at any point during the compression cycle. Ensure that the apparatus is capable of recording, on a chart, forces from 0.0 to 500.0 lb.
 - 2.2. Knife: Provide a long, slender-blade knife that can be sharpened to a keen edge and will not leave imperfections in the cut section of the seal.
3. SAMPLE -
 - 3.1. Cut a test specimen at random from a 6-ft-long sample.
 - 3.2. Ensure that the test specimen is 4.0 ± 0.1 in. long. Ensure that the severed end is perpendicular to the long axis of the specimen.
4. PROCEDURE –
 - 4.1. Ensure that the test temperature is 77 ± 4 °F.
 - 4.2. Place the test specimen between the compression plates in such a manner that the load will be applied evenly along its length.
 - 4.3. Compress the test specimen by application of the load along its sides at a constant rate of one inch per minute. Record the applied force at 15 and 50-percent deflection.
 - 4.4. Continue to compress the test specimen until closure of the seal occurs. Ensure that the seal does not deflect more than 70 percent of the original width before closure occurs. Consider deflections recorded in excess of 70 percent of the original seal width as failures.

4.5. Subject each specimen to three compression cycles. Obtain the required readings on the third compression cycle.

5. CALCULATIONS: Calculate the compression-deflection resistance pressure according to the following formula:

$$P = \frac{F}{L \times H},$$

where:

P = the pressure, in lb/in.², at the percent of compression-deformation specified;

F = the compression force to the nearest 0.5 lb.;

L = the length of the specimen to the nearest 0.1 in.; and

H = the height of the specimen to the nearest 0.1 in.

6. REPORT: Report values for the pressure, P, to the precision indicated by the specifications.

APPROVED



DIRECTOR
DIVISION OF MATERIALS

DATE

03/07/06

Kentucky Method 64-409-06

Dated 03/07/06

Supersedes KM 64-409-02

Dated 12/13/01

PREPARING INGREDIENT MATERIALS FOR, AND PERFORMING,
A LABORATORY MIX DESIGN OF AN ASPHALT MIXTURE

1. SCOPE:

- 1.1. This method covers the procedure for preparing the ingredient materials for, and performing, a laboratory design of an asphalt mixture. While determining the design aggregate structure for a given design and in the following laboratory mix design analyses [all as described in AASHTO R 30, *Mixture Conditioning of Hot Mix Asphalt (HMA)*; AASHTO R 35, *Superpave Volumetric Design for Hot Mix Asphalt (HMA)*; AASHTO T 312, *Preparing and Determining the Density of Hot Mix Asphalt (HMA) Specimens by Means of the Superpave Gyrotory Compactor*; and ASTM D 4867, *Effect of Moisture on Asphalt Concrete Paving Mixtures*], use this method to prepare the aggregate, asphalt binder, and other applicable materials for laboratory testing.
- 1.2. This method serves as a supplement to AASHTO R 30, AASHTO R 35, AASHTO T 312, and ASTM D 4867, outlining the preparation of the ingredient materials and the noted deviations from the national standard. The national standards apply unless specifically modified herein.
- 1.3. This method also establishes the procedure for the initial and continuing approval of mix design laboratories.

2. LABORATORY APPROVAL

2.1. Initial approval

- 2.1.1. The Department will require laboratories with no previous experience on Department projects to be inspected by Division of Materials (Division) personnel or maintain AASHTO accreditation for the appropriate tests prior to accepting laboratory mix designs.
- 2.1.2. The Department will grant initial approval only after a sufficient number of mix designs have been submitted and verified to establish satisfactory “between-laboratory” comparisons and confidence in the results generated by the laboratory under evaluation.

2.2. Continuing approval

- 2.2.1. In order to ensure the continued proficiency of laboratory personnel and equipment, annually participate in the Asphalt Mixture Cooperative Testing Program offered by the Division. This program supplies asphalt mixtures to all laboratories that provide mix designs for Department projects, analyzes the test results, and returns a comparative evaluation. Investigate ratings of “0”, “1”, or “2” to discover possible

adjustments needed in testing procedures or equipment.

3. LABORATORY EQUIPMENT:

- 3.1. Mixing Apparatus: Perform mixing mechanically or manually. Provide a metal pan or bowl of sufficient capacity for mixing operations. Maintain the mixture at the required mixing temperature; produce a well-coated, homogeneous mixture of the required amount in the allowable time. Ensure essentially all of the batch can be recovered.
- 3.2. Scales: Provide scales with a capacity of no less than 10 kg, sensitive to 0.1 g, for weighing aggregates and batching mixtures. Ensure the scales satisfy the requirements of AASHTO M 231, *Weighing Devices Used in the Testing of Materials*, for the type of scales required for the material being tested.
- 3.3. Provide a minimum of two forced-draft ovens, thermostatically controlled, capable of maintaining the desired temperatures within the applicable tolerances.
- 3.4. Miscellaneous Equipment:
 - 3.4.1. Provide thermometers, dial-type with metal stems, liquid-in-glass, or digital, for determining temperatures of aggregates, asphalt binders, and asphalt mixtures. Ensure all thermometers provide a range from 50 to 400 °F, with a sensitivity of 5 °F.
 - 3.4.2. Provide metal or plastic buckets for storing different sizes and types of aggregates.

4. PREPARATION OF MATERIALS:

- 4.1. Aggregate:
 - 4.1.1. Determine the bulk oven-dry (BOD) specific gravity of each aggregate component according to AASHTO T 85, *Specific Gravity and Absorption of Coarse Aggregate*, or [KM 64-605](#), *Specific Gravity and Absorption of Fine Aggregate*, as appropriate.
 - 4.1.2. Obtain samples of aggregate from the field in accordance with AASHTO T 2, *Sampling of Aggregates*. Ensure the aggregate samples represent the actual material that will be supplied to the project. The samples may consist of material: (1) retrieved from the stockpiles at a plant-site; (2) that has been ran through a mixing plant in a “dry process;” (3) obtained from the “hot bins” of a mixing plant; or (4) recovered from any other method approved by the Department of Highways.
 - 4.1.3. Reduce the aggregate samples, according to AASHTO T 248, *Reducing Samples of Aggregate to Testing Size*, to sizes specified in AASHTO T 27, *Sieve Analysis of Fine and Coarse Aggregates*.
 - 4.1.4. Wash and grade each aggregate sample according to AASHTO T 11, *Materials Finer Than 75- μ m (No. 200) Sieve in Mineral Aggregates by Washing*, and AASHTO T 27.

- 4.1.5. Blend the aggregate fractions according to AASHTO R 35.
- 4.1.6. Prepare a minimum of three aggregate trial blends according to AASHTO R 35. Alternatively, use experience with the given materials to select a design aggregate structure without utilizing the trial blend process.
- 4.1.7. Conduct the aggregate consensus property tests on the trial blends or the selected design aggregate structure according to AASHTO M 323, *Superpave Volumetric Mix Design*.
- 4.1.8. Use the instructions given in the following subsections of this method in conjunction with AASHTO R 35 and ASTM D 4867, as applicable, to prepare aggregate for:
 - 4.1.8.1. Dry all aggregate in an oven at 221 to 230 °F. Next, combine each type and size of aggregate according to the desired percentage, by weight of the total combined aggregate, corresponding to the proposed cold-feed or hot-bin percentages determined in Subsection 4.1.6 of this method.
 - 4.1.8.2. Grade the combined aggregate into each particular sieve size. Grade that quantity of aggregate necessary to produce the desired number of mix-design samples and specimens. Separate each sieve size, and place the material in a distinct container, such as a bucket. Immediately label the size of material in each container.
 - 4.1.8.3. Next, “weigh up” a sample of dry aggregate corresponding to the proposed job-mix formula (JMF). The JMF is a single percentage passing each specified sieve size for the given type of mixture. The proposed JMF may be an attempted trial blend or a selected design aggregate structure; use the same process for both. This “weighing up” process involves the determination, and subsequent weighing, of the amount of material necessary from each sieve size to yield the percentage retained on that sieve size, specified by the proposed JMF, as a part of the total “batch size.” This “batch size” for volumetric specimens is the total amount of aggregate necessary to achieve a height of $115.0 + 5.0$ mm at N_{des} and N_{max} gyrations on each compacted specimen after mixing the dry aggregate with the appropriate amount of asphalt binder. In general, use 4600 g of dry aggregate when producing the first test specimen (see [Subsection 5.3](#) of this method) for a given mixture. The “batch size” for moisture-susceptibility (ASTM D 4867) specimens is the total amount of aggregate necessary to achieve an air-void content of 7.0 ± 1.0 percent after mixing the dry aggregate with the appropriate amount of asphalt binder.

4.1.8.4. Since the concept of “weighing up” is so very complicated to understand from written instructions alone, follow the example below that demonstrates the calculations involved. This example considers a 1.5-in.-nominal Superpave mixture, tested for volumetric properties, “weighed up” to a total “batch size” of 4600 g of dry aggregate. Calculate the weight per sieve by multiplying the percentage retained on that sieve by the batch size as displayed below:

<u>Sieve Size</u>	<u>Percent Passing (Proposed JMF)</u>	<u>Percent Retained</u>	<u>Batch Size (g)</u>	<u>Weight per Sieve (g)</u>	<u>Cumulative Weight (g)</u>
2 in.	100	0	4600	0	0
1 1/2 in.	92	8	4600	368	368
1 in.	72	20	4600	920	1288
No. 4	25	47	4600	2162	3450
No. 8	16	9	4600	414	3864
No. 16	11	5	4600	230	4094
No. 30	8	3	4600	138	4232
No. 50	6	2	4600	92	4324
No. 200	4.0	2.0	4600	92	4416
PAN	0	4.0	4600	184	4600

4.1.8.5. In reference to the sample to be “weighed up” (mentioned in Subsection 4.1.8.3 of this method earlier), “weigh up” a 4600-g quantity of dry aggregate according to the above values. Specifically, place 368 g of material from the bucket that contains the 1 1/2-in.-size aggregate in a container, then place 920 g of material from the 1-in. bucket in the same container, and so on. After completing the entire 4600-g sample, perform a wet-sieve analysis on the entire sample, in accordance with AASHTO T 11 and T 27. Keep in mind that the 4600-g sample under consideration is just an example; apply the same procedure regardless of the type of mixture and “batch size” involved.

4.1.8.6. After performing the wet-sieve analysis on the aforementioned sample, analyze the results to define the dry gradation to be used for “weighing up” the remainder of the mix-design specimens and samples. The goal of this exercise is the determination of the dry gradation that, when subjected to a wet-sieve analysis, will yield a gradation identical to the proposed wet-sieve JMF. Continuing with the values considered previously, the following table displays the results from the wet-sieve analysis performed on the 4600-g sample (“weighed up” to correspond with the proposed JMF):

<u>Sieve Size</u>	<u>Wet-Sieve Gradation</u>	<u>Gradation “Weighed Up”</u>	<u>Difference</u>
2 in.	100	100	0
1 1/2 in.	93	92	+ 1
1 in.	73	72	+ 1
No. 4	25	25	0
No. 8	17	16	+ 1
No. 16	12	11	+ 1
No. 30	9	8	+ 1
No. 50	8	6	+ 2
No. 200	6.0	4.0	+ 2.0

4.1.8.7. Following this process, perform a comparison of the wet-versus-dry gradation values, and estimate an adjustment. The goal of this adjustment is the determination of the particular dry JMF that, when analyzed by wet-sieve procedures, will return a gradation which matches the proposed JMF. Normally, the smaller sieves (e. g., No. 50 and smaller) reveal the greatest change between dry and wet gradations, as the above example displays. Also, these sieves are usually the only ones that require any adjustment in gradation. In fact, unless the difference between the wet- and dry-sieve gradations is dramatic (e. g., more than 3 percent) on the larger sieves (i. e., No. 30 and above), do not make an adjustment on these sieves. Listed below is the trial gradation to use as a first effort in the “trial-and-error” process, based on the differences observed in the wet-versus-dry comparison above:

<u>Sieve Size</u>	<u>Adjusted Dry Gradation</u>
2 in.	100
1 1/2 in.	92
1 in.	72
No. 4	25
No. 8	16
No. 16	11
No. 30	8
No. 50	4
No. 200	2.0

4.1.8.8. As the preceding example exhibits, only adjust the No. 50 and No. 200 sieves. The amount of adjustment on those sieves is equal to the difference between the wet- and dry-sieve analyses displayed in Subsection 4.1.8.6 of this method previously. Presumably, a wet-sieve analysis, performed in accordance with AASHTO T 11 and T 27 on the above gradation presented in Subsection 4.1.8.7 of this method, would yield results that very closely match the proposed JMF. Accordingly, a check of that agreement is the next step in the process. Perform a wet-sieve analysis on the adjusted gradation

displayed above, and hopefully, the result of that analysis will be a gradation identical to the proposed JMF. If such an agreement is the case, having then determined the final “weigh-up” gradation, proceed with the testing process. If, however, the wet-sieve analysis of the adjusted JMF is not in reasonable conformance (i. e., within \pm 1 percent on all sieves) with the proposed gradation, then make another adjustment to the trial dry gradation, and repeat the process. Continue this “fine-tuning” procedure until determining a dry gradation that, when subjected to a wet-sieve analysis, yields results that are reasonably similar to the proposed JMF. Use this gradation to “weigh up” all volumetric and moisture-susceptibility (ASTM D 4867) specimens for the mixture in question. When submitting mix designs to the Division, include both the dry, “weigh-up” gradation and the resulting wet gradation with the mixture submittal.

- 4.1.8.9. As an option, when desiring to simulate the gradation of the mixture after mixing at the asphalt plant, add some amount of fine material. Typically, this fine aggregate is from the containers holding the “No. 50,” “No. 200,” and “pan” material. Determine the amount of fine material to add based on experience with the aggregates and asphalt mixing plant involved, but do not vary the “weigh up” gradation by more than 1.0 percent on the No. 50 sieve or by more than 1.5 percent on the No. 200 sieve. When performing this gradation adjustment on mix designs submitted to the Division, include both the adjusted dry, “weigh-up” gradation and the resulting wet gradation with the mixture submittal as required in Subsection 4.1.8.8 of this method.

4.2. Asphalt Binder:

- 4.2.1. Obtain the sample of asphalt binder to be utilized for further testing from the appropriate asphalt binder shipping terminal, preferably from the very material to be shipped to the project for which the particular mix design is being completed. When the acquisition of a sample of asphalt binder dedicated for the project in question is either impossible or impractical, then at the very least, ensure the asphalt binder to be utilized is relatively fresh and originates from the appropriate shipping terminal.
- 4.2.2. Minimize the number of times that the asphalt binder is heated from a semi-solid state. If, during the entire process of obtaining a sample of asphalt binder, it is necessary to heat the material more than once before utilizing the asphalt binder for testing, then obtain approval for this deviation from the normally accepted practice from the Engineer.
- 4.2.3. The mixing and compaction temperatures to observe for each mix-design specimen are a function of the particular asphalt binder and are selected according to the application [i.e., hot mix asphalt (HMA) or warm mix asphalt (WMA)]. See [Subsection 5.2](#) of this method for these values.

- 4.2.4. Calculate the grams of asphalt binder required to produce a gyratory specimen or G_{mm} sample by the following formula:

$$\text{Grams of asphalt binder} = \frac{(\text{Aggregate Batch Weight in g})(\text{Asphalt Binder Content in \%})}{100 - \text{Asphalt Binder Content in \%}}$$

- 4.2.5. As an example, determine the grams of asphalt binder required for 4600 g of dry aggregate to produce an asphalt binder content (AC) of 5.0 percent. See the calculation below:

$$\text{Grams of asphalt binder} = \frac{(4600)(5.0)}{100 - 5.0} = 242 \text{ g.}$$

4.3. Anti-Stripping Additive:

- 4.3.1. Experience reveals that, for most mixtures, the addition of a normal amount of an anti-stripping additive to a mixture containing an otherwise unmodified asphalt binder will not significantly affect the volumetric properties of that mixture. The Department reserves the right, however, to request the Contractor to furnish additional mixture specimens and/or G_{mm} samples produced at the optimum AC with asphalt binder that contains anti-stripping additive.

5. SPECIMEN PRODUCTION:

- 5.1. *Required Compaction (number of gyrations)*: In general, consult the mixture's bid item to determine the required number of gyrations for volumetric specimens. The ESAL Class given in the bid item corresponds to the ESAL range given in Subsection 403.03.03 of the *Standard Specifications*. Compact the specimen to N_{des} and N_{max} gyrations as specified in Subsection 403.03.03 of the *Standard Specifications* and AASHTO T 312.
- 5.2. *Mixing and Conditioning/Compaction Temperatures*:
- 5.2.1. Mix and condition/compact specimens at the following temperatures ± 10 °F, depending on the performance grade (PG) of the asphalt binder in the mixture and application (HMA or WMA):

<u>Asphalt Binder</u>	<u>HMA Mixing Temp. (°F)</u>	<u>HMA Conditioning/Compaction Temp. (°F)</u>
PG 64-22	300	265
PG 76-22	330	300

<u>Asphalt Binder</u>	<u>WMA Mixing Temp. (°F)</u>	<u>WMA Conditioning/Compaction Temp. (°F)</u>
PG 64-22	265	245
PG 76-22	290	275

5.2.2. Use these values for laboratory mix designs and volumetric testing of plant-produced mixture. Adjust these temperatures and tolerances for mixing at the plant or compaction at the paving site as necessary, but always conform to the ranges given in Subsection 401 of the Department’s *Standard Specifications for Road and Bridge Construction*.

5.3. Initial Batch and Test Specimen for Volumetric Testing:

5.3.1. Before any mixing occurs for the actual volumetric analysis, produce an initial batch for the purpose of “buttering” the mixture bowl and related mixing equipment. Empty this batch after mixing, and clean the sides of the bowl and stirrers of mixture residue by scraping with a small limber spatula, but do not wipe the apparatus with a cloth or wash it clean with solvent, except when making a change in the asphalt binder or at the end of a run.

5.3.2. After completing the initial batch and cleaning the mixing equipment of residue, produce a test specimen. Using the “weigh-up” gradation determined in Subsection 4.1.8.8 or 4.1.8.9 of this method, weigh the amount of each size fraction required to produce a batch that will result in a compacted specimen 115.0 + 5.0 mm in height (approximately 4600 g) at N_{des} and N_{max} gyrations. Estimate the AC at which this test specimen is mixed as a value typical of optimum AC values for such an aggregate source and gradation. See Subsection 4.2.4 of this method for instructions to calculate the appropriate amount of asphalt binder to mix with the aggregate.

5.3.3. Heat, mix, condition, and compact the material according to AASHTO R 30, R 35, Subsection 403.03.03 of the *Standard Specifications*, and AASHTO T 312. Use separate ovens to heat the materials to be mixed and condition the mixture at the appropriate temperatures. Determine the height of the completed test specimen from the gyratory compactor.

5.3.4. Determine the corrected aggregate weight according to the following equation:

$$\text{Corrected Aggregate Weight} = \frac{115.0(\text{Estimated Aggregate Weight in g})}{\text{Height of Specimen in mm}}$$

NOTE 1: When considering compacted mixture specimens, use the formula above to correct the height of a specimen by replacing “Corrected Aggregate Weight” with “Corrected Specimen Weight,” and “Estimated Aggregate Weight” with “Actual Specimen Weight.” Remember to adjust the asphalt binder weight to correlate with the new aggregate weight. Use this corrected weight as the value to which to weigh the remainder of the volumetric specimens during a given analysis.

5.4. Heating of Materials and Equipment and Mixing of Volumetric Specimens:

- 5.4.1. After “weighing-up” the dry aggregate for each specimen, using the gradation determined in Subsection 4.1.8.8 or 4.1.8.9 of this method and the weight determined in Subsection 5.3.4 of this method, place the dry aggregate blend on a hot plate or in the oven. Heat the aggregate to a temperature not exceeding the mixing temperature from Subsection 5.2 of this method by more than 50 °F. Also, heat the asphalt binder to a temperature such that the specimen can be mixed at the mixing temperature required in Subsection 5.2 of this method. Next, clean the specimen mold assembly, and heat it to the applicable compaction temperature.
- 5.4.2. Charge the mixing bowl with the heated aggregate. Form a crater in the dry blended aggregate, and weigh the preheated required amount of asphalt binder, as well as any solid additives, into the mixing bowl. Exercise care to prevent loss of the mix during mixing and subsequent handling. At this point, ensure the temperature of the aggregate and asphalt binder, as well as any solid additives, is within the limits of the mixing temperature from Subsection 5.2 of this method. Mix these materials rapidly until thoroughly coated.
- 5.4.3. Complete the heating, mixing, conditioning, and compacting process according to AASHTO R 30, R 35, Subsection 403.03.03 of the *Standard Specifications*, AASHTO T 312, and the applicable portions of this method for all gyratory specimens and accompanying G_{mm} samples. Use separate ovens to heat the materials to be mixed and condition the mixture at the appropriate temperatures. Contrary to AASHTO R 35, produce three G_{mm} samples at the midpoint of the AC range chosen for the volumetric portion of the overall analysis. After testing these G_{mm} samples, average the values, and calculate the effective specific gravity of the aggregate (G_{se}) from the average according to Kentucky Method (KM) 64-438, *Asphalt Binder Content Determination of Asphalt Mixtures Based on the Maximum Specific Gravity*. Using the G_{se} value, “back-calculate” the G_{mm} values for the particular AC values at which the design was performed as described in KM 64-438.

5.5. Heating of Materials and Equipment and Mixing of Moisture-Susceptibility (ASTM D 4867) Specimens:

- 5.5.1. Conform to the same procedure as given in Subsection 5.4 of this method, except use an aggregate weight that will produce an air-void content of 7.0 ± 1.0 percent after mixing the dry aggregate with the appropriate amount of asphalt binder.
- 5.5.2. Complete the heating, mixing, conditioning, and compacting process according to AASHTO R 30, R 35, Subsection 403.03.03 of the *Standard Specifications*, AASHTO T 312, ASTM D 4867, and the applicable portions of this method for all moisture-susceptibility specimens and accompanying G_{mm} samples. Use separate ovens to heat the materials to be mixed and condition the mixture at the appropriate temperatures.

APPROVED William Broyles
DIRECTOR
DIVISION OF MATERIALS

DATE 04/01/09

Kentucky Method 64-411-09
Revised 04/01/09
Supersedes KM 64-411-05
Dated 12/28/04

Kentucky Method 64-415-08
Revised 02/21/08
Supersedes KM 64-415-03
Dated 01/10/03

NON-VOLATILE TEST FOR ASPHALT MASTIC

1. SCOPE: This test method covers measuring the resulting loss of volatile material when a sample of asphalt mastic is heated in an oven at 221-230 °F for 24 hours.
2. APPARATUS:
 - 2.1. Provide an electrically-heated oven, conforming to all oven requirements in ASTM E 145, *Standard Specification for Gravity-Convection and Forced-Ventilation Ovens*, Type II B, capable of maintaining a test temperature of 221-230 °F.
 - 2.2. Provide a disposable tin cup, capable of holding a 10-g sample. Ensure the cup is able to maintain a near-constant weight when exposed to heat (230 °F) for 24 hours.
 - 2.3. Provide a balance conforming to AASHTO M231, *Weighing Devices Used in the Testing of Materials*, (Table 1) Class B.
3. SAMPLE: Ensure that the size of the test sample is approximately 10 g.
4. PROCEDURE:
 - 4.1. Weigh the tin cup to the nearest 0.001 g, and record the weight as “B”.
 - 4.2. Place approximately 10 g of the material to be tested in the previously-weighed tin cup.
 - 4.3. Weigh the cup and material to the nearest 0.001 g, and record the weight as “A”.
 - 4.4. Place the cup in an oven maintained at 221-230 °F for a period of 24 hours.
 - 4.5. Remove the cup from the oven, and allow it to cool to room temperature in a dessicator.
 - 4.6. Weigh the cup and material to the nearest 0.001 g, and record the weight as “C”.

5. CALCULATIONS: Calculate the loss of volatile material according to the following equation:

$$\text{Percent of Non - Volatile Material} = 100 \left(\frac{C - B}{A - B} \right)$$

where:

A = the weight of the tin cup and material;

B = the weight of the tin cup; and

C = the weight of the tin cup and material after 24 hours in the oven.

6. REPORT: Report the percent of non-volatile material to the nearest whole percent.

APPROVED

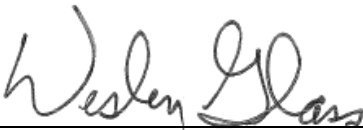

DIRECTOR
DIVISION OF MATERIALS

DATE

02/21/08

Kentucky Method 64-415-08
Revised 02/21/08
Supersedes KM 64-415-03
Dated 01/10/03

Kentucky Method 64-416-08
Revised 02/21/08
Supersedes KM 64-416-02
Dated 12/13/01

PLASTIC SET TEST FOR ASPHALT MASTIC

1. SCOPE: This test method measures the toughness, shrinkage, adhesion, and cracking of asphalt mastic after curing.
2. APPARATUS -
 - 2.1. Provide a tinned panel, approximately 5 by 3 by 0.013 inches.
 - 2.2. Provide a spatula, capable of spreading the sample into a “smear” which is 1/16 to 1/8 of an inch thick.
3. SAMPLE: Ensure that the size of the test sample is 3.0 ± 0.5 g.
4. PROCEDURE -
 - 4.1. Apply the thin layer of the asphalt mastic, which is 1/16 to 1/8 of an inch thick and weighs approximately 3 g, to the tinned panel.
 - 4.2. Allow the specimen to cure at room temperature for 24 hours.
 - 4.3. Visually examine the specimen for the following:
 - 4.3.1. Toughness;
 - 4.3.2. Shrinkage;
 - 4.3.3. Adhesion to the tinned panel; and
 - 4.3.4. Cracking.

5. REPORT: Ensure that the asphalt mastic sets to a tough, plastic coating and does not shrink, crack, or loosen from the surface after the 24-hour cure period.

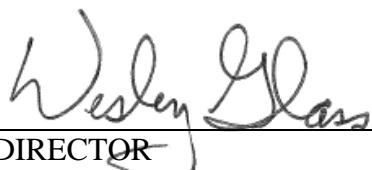
APPROVED 

DIRECTOR
DIVISION OF MATERIALS

DATE 02/21/08

Kentucky Method 64-416-08
Revised 02/21/08
Supersedes KM 64-416-02
Dated 12/13/01

CORING ASPHALT PAVEMENT FOR THICKNESS

1. SCOPE:

- 1.1. This method provides for thickness determination by the coring of newly constructed asphalt pavement in new construction applications.

NOTE 1: Do not obtain cores for projects involving less than 10,000 square yd. of asphalt pavement. In this case, the Department will accept thickness on the basis of inspection of the application rate and a visual inspection of placement.

- 1.2. Obtain cores for specification compliance after completing all courses of asphalt pavement and necessary leveling. When requested by the Department, core part of the total surfacing area of the project prior to completion of all asphalt pavement work.

1.3. Coring:

- 1.3.1. Obtain the cores at no expense to the Department. Provide both the coring and core-measuring equipment specified in Subsection 2 of this method. Complete the coring in accordance with this method and at locations identified by the Department. The Department will measure the cores; the appropriate District Materials Section Supervisor (DME) will retain a report of the thickness results along with each location.

- 1.3.2. When the re-coring of deficient sections after the application of additional material is necessary, perform the coring at no expense to the Department.

- 1.4. The DME will report the core results and calculate the amount of non-specification tonnage (excessive or deficient quantities) using the "Pavement Management Software" computer program developed by the Department for this purpose.

- 1.5. In applying the computer program, the Department will not include excessive or deficient quantities for areas within 200 linear ft. of bridge ends.

2. APPARATUS:

- 2.1. Coring equipment: Provide a core-drill rig with diamond masonry bits capable of obtaining a core with a minimum diameter of 4 ± 0.1 in.

- 2.2. Core measurement: Provide calipers in accordance with [Kentucky Method \(KM\) 64-308, Method of Measuring Length of Drilled Cores](#).

3. CORING:

3.1. Coring frequency:

- 3.1.1. Routine cores: For determining normal specification compliance, obtain one routine core to represent each lot consisting of a 1000-linear-ft. section of mainline pavement (or fraction thereof, providing the fractional section exceeds 500 linear ft.), edge to edge (including truck lanes). When the design depth of the shoulders matches the mainline pavement, obtain a single routine core for each 1000 ft. to represent the

entire width of the mainline plus shoulders. When shoulders are in excess of 3 in. thick and have a different design depth than the mainline pavement, obtain cores separately from the mainline and at the following frequencies for shoulders (or fraction thereof, providing the fractional section exceeds half of the normal distance between shoulder cores):

<u>Width of Shoulder (ft.)</u>	<u>Distance Between Cores (ft.)</u>
2	11,250
4	5625
6	3750
8	2813
10	2250

For pavement sections separated by a median, barrier wall, or other physical demarcation, core the pavement sections independently according to the requirements above.

- 3.1.2. Exploratory cores: When a routine core is out of the allowable specification tolerances, obtain exploratory cores every 200 ft., backward and forward, until a core within specification tolerance is obtained. Adjust this 200-ft. interval to avoid obtaining any exploratory cores closer than 100 ft. of bridge ends.
- 3.2. Determining coring locations:
 - 3.2.1. If possible, start coring on the section beginning with the smaller station numbers.
 - 3.2.2. In the first 1000-ft. section, select a coring location (station number) at random. Obtain the second routine core approximately 1000 ft. from the first; the third, 1000 ft. from the second; etc. Adjust the 1000-ft. intervals for routine cores when necessary to avoid obtaining any cores closer than 200 ft. of bridge ends.
 - 3.2.3. Bridges or other physical discontinuities that require an adjustment in the 1000-ft. sections may also require the selection of a new location for beginning the coring. Consider the edge of the mainline to be a physical discontinuity when coring entrances and approach roads.
 - 3.2.4. Vary the transverse-coring locations for routine cores, but do not obtain cores closer than two feet to the edge of the pavement or curb. Obtain exploratory cores both ahead and behind the out-of-specification, routine core in the direction of the two adjacent, routine-core locations. Determine the transverse location of the exploratory cores by interpolation between the distances from the centerline of the two routine-core locations between which the exploratory cores are being taken.
 - 3.2.4.1. For example, a routine core (Core A), taken 10 ft. right of the centerline, is out of the allowable specification tolerance. The last routine core within the allowable specification tolerance, Core B, taken 10 ft. left of the centerline, is 1000 ft. behind Core A. Obtain the first exploratory core 200 ft. behind Core A in the direction of Core B at 6 ft. right of the centerline. Determine this transverse location by taking 20 percent (200 linear ft./1000 linear ft.) of the 20-ft. transverse span between Core A and Core B. If necessary, obtain the second exploratory core 400 ft. behind Core A in the direction of Core B at 2 ft. right of the centerline. Determine this transverse location by taking 40 percent (400 linear ft./1000 linear ft.) of the 20-ft. transverse span between Core A and Core B. In the same manner,

if necessary, obtain the third exploratory core 600 ft. behind Core A in the direction of Core B at 2 ft. left of the centerline. Finally, if necessary, obtain the fourth exploratory core 800 ft. behind Core A in the direction of Core B at 6 ft. left of the centerline.

3.2.4.2. Similarly, obtain exploratory cores ahead of Core A at 200-ft. intervals until obtaining a core within the allowable specification tolerance. Declare a transverse distance from the centerline for a theoretical Core C, located 1000 ft. ahead of Core A. For example, if the theoretical Core C would be taken at 6 ft. left of the centerline, obtain the first exploratory core 200 ft. ahead of Core A in the direction of Core C at 6.8 ft. right of the centerline. Determine this transverse location by taking 20 percent (200 linear ft./1000 linear ft.) of the 16-ft. transverse span between Core A and Core C. If necessary, obtain the second exploratory core 400 ft. ahead of Core A in the direction of Core C at 3.6 ft. right of the centerline. Determine this transverse location by taking 40 percent (400 linear ft./1000 linear ft.) of the 16-ft. transverse span between Core A and Core C. In the same manner, if necessary, obtain the third exploratory core 600 ft. ahead of Core A in the direction of Core C at 0.4 ft. right of the centerline. Finally, if necessary, obtain the fourth exploratory core 800 ft. ahead of Core A in the direction of Core C at 2.8 ft. left of the centerline.

3.3. Core all mainline pavement, shoulders in excess of 3 in. depth, and ramps. Core entrances and approach roads when greater than 300 ft. in length. Do not core transition zones of variable thickness necessary to match existing grades.

3.4. The Department will measure the cores in accordance with [KM 64-308](#).

4. PROCEDURE FOR DETERMINING NON-SPECIFICATION AREAS:

4.1. Non-specification area: The Department will determine the area of a section that is considered non-specification in thickness as follows:

4.1.1. Width: The Department will consider the width of the section as the average design width, or other approved width, that the cores represent. Other approved widths include additional widening where directed by the Department.

4.1.2. Length: The Department will consider the length of the section equal to the sum of: (1) the length represented by either consecutive, deficient-thickness cores or consecutive, excessive-thickness cores; plus (2) a proportionate length on each end between the first (or last) non-specification core and the adjacent, in-specification core. The Department will determine the proportionate, non-specification part on each end by ratio/proportion calculations or by graphing.

NOTE 2: The Department will perform this calculation automatically using the computer program.

4.2. The Department will determine the quantities for non-specification areas as follows:

4.2.1. Excess thickness: When a core measurement is in excess of 0.5 in. of the compacted, plan thickness, the Department will report the quantity in excess of the 0.5-in. tolerance as a non-specification, excess quantity. The Department will determine this quantity by multiplying the calculated, excess volume by the density used as a basis for establishing contract quantities and report the quantity in tons (Note 2).

4.2.2. Deficient thickness: When a core measurement is deficient by more than 0.5 in. from the compacted, plan thickness, the Department will determine the total deficient quantity from the compacted, plan thickness by multiplying the calculated deficient volume, including the 0.5-in. tolerance, by the density used as a basis for establishing contract quantities and report the quantity in tons (Note 2).

5. REPORT: The Department will include the following information in each core-thickness report.
- 5.1. The plan (design) thickness.
 - 5.2. The thickness of all cores, routine and exploratory (when necessary).
 - 5.3. The stations (length), location of the deficient-thickness sections, and quantity (tons) deficient from the design thickness.
 - 5.4. The stations (length), location of the excessive-thickness sections, and quantity (tons) in excess of the design thickness.

APPROVED William Boyles
DIRECTOR
DIVISION OF MATERIALS

DATE 05/19/09

Kentucky Method 64-420-09
Revised 05/19/09
Supersedes KM 64-420-04
Dated 07/15/04

ESTABLISHING THE JOB-MIX FORMULA OF ASPHALT MIXTURES
BY THE CONTRACTOR

1. SCOPE:
 - 1.1. This method covers the requirements for the Contractor to establish his job-mix formula (JMF) for a project.
 - 1.2. The JMF for a mix is defined as: (1) a single percentage (passing) for each specified sieve size for the aggregate gradation; and (2) a specified performance-graded (PG) asphalt binder content (AC) expressed to the nearest 0.1 percent. The JMF is specified as a whole number on all applicable sieves, except the No. 200 sieve, which is specified to the nearest 0.5 percent.
 - 1.3. Establishing the JMF consists of two distinct phases.
 - 1.3.1. In the first phase, submit the desired aggregate-blend combination and resulting proposed-mix gradation to the Division of Materials (the Division) or District Materials Section Supervisor (DME), as appropriate, for evaluation. The Department will use a qualified Superpave Mix-Design Technologist (SMDT) to report the acceptability of mix designs.
 - 1.3.2. In the second phase, set the plant according to the JMF reported on the most current version of the “Asphalt-Mixture-Design Results” form, or “MixPack” spreadsheet.
 - 1.4. Provide a qualified SMDT to submit the mixture design to the appropriate party for evaluation; provide a qualified Superpave Plant Technologist (SPT) to establish the JMF at the plant.

2. APPARATUS: Refer to the following Kentucky Methods (KM’s) and AASHTO and ASTM procedures, as applicable, for the equipment and procedures necessary to fulfill the requirements of this method:

- [KM 64-401](#) *Calibrating and Checking Cold-Feed Flow on Asphalt Mixing Plants*
- [KM 64-404](#) *Sampling Liquid Asphalt Materials*
- [KM 64-405](#) *Extraction of Binder From Asphalt Paving Mixtures*
- [KM 64-407](#) *Sieve Analysis of Aggregate From Asphalt Mixing Plants*
- [KM 64-411](#) *Preparing Ingredient Materials for, and Performing, a Laboratory Mix Design of an Asphalt Mixture*

KM 64-424	<i>Method for Designing Open-Graded Friction Course Mixtures</i>
KM 64-425	<i>Sampling Asphalt Mixtures</i>
KM 64-433	<i>Wet-Sieve Analysis of Aggregates Used in Asphalt Mixtures</i>
KM 64-434	<i>Determination of Moisture Content in Asphalt Mixtures (Rapid Field Test)</i>
KM 64-436	<i>Asphalt Binder Content Determination of Asphalt Mixtures by Plant Recordation</i>
KM 64-437	<i>Determination of Asphalt Binder Content of Asphalt Mixtures Using the Nuclear Asphalt Content Gauge</i>
KM 64-438	<i>Asphalt Binder Content Determination of Asphalt Mixtures Based on the Maximum Specific Gravity</i>
KM 64-443	<i>Method for Verifying a Contractor's Laboratory Mix Design</i>
KM 64-444	<i>Kentucky Transportation Cabinet (KYTC) Approved Supplier Certification (ASC) Program for Performance-Graded (PG) Asphalt Binders</i>
KM 64-450	<i>Determination of Cracking Resistance (KYCT) of Bituminous Mixtures</i>
KM 64-620	<i>Wet Sieve Analysis of Fine and Coarse Aggregate</i>
AASHTO M 323	<i>Superpave Volumetric Mix Design</i>
AASHTO R 35	<i>Superpave Volumetric Design for Hot Mix Asphalt (HMA) Sampling of Aggregates</i>
AASHTO T 2	<i>Sieve Analysis of Fine and Coarse Aggregates</i>
AASHTO T 27	<i>Determining the Asphalt Binder Content of Hot Mix Asphalt (HMA) by the Ignition Method</i>
AASHTO T 308	<i>Hamburg Wheel-Track Testing of Compacting Asphalt Mixtures</i>
AASHTO T 324	<i>Effect of Moisture on Asphalt Concrete Paving Mixtures</i>
ASTM D 4867	

3. SELECTING THE JMF:

- 3.1. Document the selected JMF on an “Asphalt-Mixture-Design Results” form, or “MixPack” spreadsheet, appropriate for the mixture in question, for transfer into the SiteManager[®] Materials computer software (example copies attached). Submit the “Asphalt-Mixture-Design Results” form to the Division or DME via computer disk or electronic mail. Additionally, retain copies of all worksheets and data so that, in case of discrepancies, all supporting information is available for review.

- 3.2. As the first step in selecting the JMF, determine the source and size of aggregates to be used in the mix. Ensure the aggregate used in the design testing is representative of that to be used on the project.
- 3.3. Determine the gradations of the stockpiled aggregates according to R 35.
- 3.4. Develop a minimum of three aggregate trial blends, combining the aggregate fractions mathematically, according to R 35.
 - 3.4.1. Determine the trial blends by the “trial-and-error” method. Assign percentages to each aggregate to be used. Attempt the first “guesses” by looking at critical sieves, which usually include the third and last sieve in the series. Multiply the assigned percentages for each aggregate by the percent passing a given sieve. Determine the sum of the product(s) obtained on a given sieve for all the aggregates. Compare the calculated gradation obtained to the desired gradation. Adjust the assigned percentage of each aggregate, and repeat the process until the “best fit” with the desired gradation is obtained.
 - 3.4.2. If desired, consult additional detailed information and examples on combining stockpile gradations to determine the JMF as provided in the *SMDT Training Manual* from the Division. Additionally, use computer spreadsheets for combining stockpile gradations if desired.
- 3.5. Conform to [KM 64-411](#) for the preparation of ingredient materials for: (1) trial blend gradations; (2) trial blend gyratory specimens and accompanying maximum specific gravity (G_{mm}) samples; (3) design aggregate structure gyratory specimens and accompanying G_{mm} samples; (4) moisture-susceptibility (D 4867) specimens and accompanying G_{mm} samples; and (5) aggregate consensus property samples.
- 3.6. According to R 35, after selecting the three aggregate trial blends, determining an initial trial AC for each trial blend, and evaluating the properties of each compacted trial mixture, choose the design aggregate structure. Record this gradation on the “Asphalt-Mixture-Design Results” form as the selected JMF as described in Subsection 3.1 of this method.
- 3.7. When previous experience exists with the same materials, submit a mix gradation, or reference mixture, which has proved satisfactory as the selected JMF, thus circumventing the requirements above.
- 3.8. Design AC:
 - 3.8.1. Select the design AC according to R 35.
 - 3.8.2. Justify the proposed AC based on: (1) a laboratory mix design, or one-point check as described later in this method, submitted by the Contractor; or (2) field-verification data sufficient to document satisfactory past performance (at least from the latest lot of mixture production). Determine the design AC, at 3.5 percent air voids, based on experience, laboratory data, and/or field-verification data. When applicable, the Division or DME will verify the Contractor’s laboratory mix design or one-point check as described in [KM 64-443](#). The Division or DME may, in

isolated cases, modify the Contractor's proposed AC due to project conditions or experience with the involved materials.

3.9. Submitting mixtures for evaluation:

3.9.1. Mixtures submitted to the Division:

3.9.1.1. Submit an "Asphalt-Mixture-Design Results" form and any samples and/or specimens which may be required for any permanent mainline, shoulder, ramp, approach, median that could be used for turning movements, cross-over, or entrance application, regardless of tonnage, for the following mixtures:

3.9.1.1.1. AADTT Class 3 or 4 Superpave mixtures, Sand Asphalt, Sand Seal Surface, Open-Graded Friction Course (OGFC), Stone-Matrix Asphalt (SMA), or Drainage Blanket - Type II - Asphalt (ATDB); or

3.9.1.1.2. Other specialty mixtures which, by nature of the ingredient materials included or the application intended, would require the Division's involvement and/or evaluation.

3.9.1.2. Submit samples of aggregate, PG binder, and liquid anti-stripping additives, if used, to the Division in the instances given below:

3.9.1.2.1. All AADTT Class 4 mixtures.

3.9.1.2.2. Sand Asphalt, Sand Seal Surface, OGFC, SMA, ATDB, and all specialty mixtures as described in Subsection 3.9.1.1.2 of this method.

3.9.1.2.3. When requested by the Division in order to investigate an unsuccessful verification according to [KM 64-443](#).

3.9.2. Mixtures submitted to the DME:

3.9.2.1. Submit an "Asphalt-Mixture-Design Results" form and any samples and/or specimens which may be required for any permanent mainline, shoulder, ramp, approach, median that could be used for turning movements, cross-over, or entrance application, regardless of tonnage, for all AADTT Class 2 Superpave mixtures.

3.9.2.2. Submit an "Asphalt-Mixture-Design Results" form outlining the mixture composition (aggregate sources and percentages, mixture gradation, PG binder source, type and amount of liquid anti-stripping additive if applicable, recommended AC, etc.) for any other mixtures or applications not previously described (such as

leveling-and-wedging, scratch course, Asphalt Mixture for Pavement Wedge, Asphalt Wedge Curb, asphalt mixture for base failure repair, mountable medians, trenches, maintenance mixtures purchased by price contract, incidental or temporary applications, etc.). The DME will not require any laboratory-mix-design testing on these mixtures.

3.9.3. Requirements for all mixtures:

- 3.9.3.1. For new mixture designs previously unsubmitted to the Department or reference mixture designs as described in Subsections 3.9.3.3 or 3.9.3.4 of this method, provide the “Asphalt-Mixture-Design Results” form and any required samples and/or specimens to the Division or DME at least 14 calendar days before the anticipated date of the start of work. When the Division’s evaluation is required, submit the samples of aggregate, PG binder, and liquid anti-stripping additive (if used) to the Division at the same time. The Division or DME will not consider any mixture as “officially received” until all required materials have been submitted.
- 3.9.3.2. Reference a previously utilized mixture without further laboratory testing, provided the following exists: (1) a laboratory mix design, or one-point check when appropriate, submitted by the Contractor; or (2) field-verification data sufficient to document satisfactory past performance (at least from the latest lot of mixture production). The date of this preliminary mixture design information can be no more than one year prior to the date of the submission of the new mixture. In this case, submit the “Asphalt-Mixture-Design Results” form to the Division or DME, as appropriate, within five working days of the anticipated date of the start of work.
- 3.9.3.3. Reference a previously utilized mixture with additional laboratory testing when the date of the preliminary mixture design information is more than one year, but less than two years, prior to the date of the submission of the new mixture. In this case, perform a one-point check of the reference mixture at the optimum AC. Along with the results of the one-point check reported on the “Asphalt-Mixture-Design Results” form, submit two mixture specimens, compacted to N_{des} gyrations, and two G_{mm} samples, all at the optimum AC, to the Division or DME, as appropriate.
- 3.9.3.4. When submitting a mixture whose preliminary design information is more than two years old, or when submitting a new mixture (not previously used), provide a complete mix design from the Contractor on the appropriate “Asphalt-Mixture-Design Results” form to the Division or DME, as appropriate. Along with this form, submit two mixture specimens, compacted to N_{des} gyrations, and two G_{mm} samples, all at the optimum AC.

3.9.3.5. When referencing to a mixture with an identical aggregate structure (sources, sizes, cold-feed percentages, and gradation) but a different grade of binder, submit an “Asphalt-Mixture-Design Results” form documenting the binder grade change to the Division or DME, as appropriate.

When requested by the Engineer, perform a moisture-susceptibility analysis with the different grade of binder, and submit the results of this analysis to the Division or DME, as appropriate. When requested, provide the Division with adequate samples of aggregate, binder, and liquid anti-stripping additive to perform a verification of the moisture-susceptibility analysis.

3.9.3.6. When referencing to a mixture with an identical aggregate structure (sources, sizes, cold-feed percentages, and gradation) and binder grade, but not the same binder source, submit an “Asphalt-Mixture-Design Results” form documenting the binder source change to the Division or DME, as appropriate.

When requested by the Engineer, perform a moisture-susceptibility analysis with binder from the different source, and submit the results of this analysis to the Division or DME, as appropriate. When requested, provide the Division with adequate samples of aggregate, binder, and liquid anti-stripping additive to perform a verification of the moisture-susceptibility analysis.

3.9.3.7. Subsection 403.03.03 of the Standard Specifications permits substitution of a mixture of one ESAL class higher than the specified asphalt mix without further testing, so the following case applies only when the referenced mixture was designed at a lower number of gyrations than the specified asphalt mix.

When referencing to a mixture with an identical aggregate structure (sources, sizes, cold-feed percentages, and gradation) and binder source and grade, but not the same number of gyrations, perform a one-point check at the higher number of gyrations at an AC that yields acceptable mixture properties. Along with that information on the “Asphalt-Mixture-Design Results” form, submit two mixture specimens and two G_{mm} samples, produced at the higher number of gyrations and the optimum AC, to the Division or DME, as appropriate.

When referencing to a mixture in this case, the Division or DME will only accept design information produced at gyration levels within one ESAL class of the reference mixture design. For example, if the reference mixture design was performed at 65 gyrations (AADTT Class 2), then the Division or DME would accept a one-point check completed at 65 gyrations (AADTT Class 3) but not a one-point check completed at 65 gyrations (AADTT Class 4).

When requested by the Engineer, if the AC changes due to the higher number of gyrations, perform a moisture-susceptibility analysis at the different AC, and submit the results of this analysis to the Division or DME, as appropriate. When requested, provide the Division with adequate samples of aggregate, binder, and liquid anti-stripping additive to perform a verification of the moisture susceptibility analysis.

When requested by the Engineer, verify that the N_{max} criterion is satisfied at the higher number of gyrations.

3.10. Submitting samples:

- 3.10.1. As given in [Subsection 3.9.1.2](#) of this method, send representative aggregate samples of all ingredient materials, including collected bag-house fines if used, to the Asphalt Mixtures Testing Section of the Division. Submit samples that accurately reflect the reported gradation according to the following guidelines:

Submit one standard sample bag, full of aggregate (approximately 70 lb_m), per 10 percent of that aggregate in the mixture (based on cold-feed percentages). For example, a 1.0-in.-nominal Superpave mixture is comprised of the following combination:

Limestone # 57's	40%
Limestone # 8's	20%
Limestone Sand	30%
Natural Sand	10%

In this case, when submitting aggregate to the Division during the mix-design process, properly sample, label, and submit four standard sample bags of limestone # 57's, two bags of limestone # 8's, three bags of limestone sand, and one bag of natural sand.

As an exception to these guidelines, when submitting aggregate to the Division for ATDB, properly sample, label, and submit two standard sample bags of each type and size of aggregate in the mixture.

- 3.10.2. Submit three gallons (in separate containers) of the PG binder, of the appropriate grade and source, for the mixture in question as specified in [Subsection 3.9.1.2](#) of this method. Also submit the PG binder supplier's certification, conforming to [KM 64-444](#), for the production lot from which these PG binder samples were obtained.
- 3.10.3. When solid additives ([Gilsonite](#), [Vestoplast](#), polyester fibers, polypropylene fibers, mineral fibers, etc.) or liquid anti-stripping additives are used in the asphalt mixture, submit a representative sample of this material to the Division with the mix-design information. Submit a sample of an adequate size to perform all necessary testing.

3.11. Review of the JMF:

- 3.11.1. The Division or DME will evaluate the acceptability of the mixture based on laboratory-mix-design data, field-verification data, and/or past experience with the proposed materials. When applicable, the DME or Division will verify the Contractor's laboratory mix design or one-point check as described in KM 64-443. The JMF reported as acceptable will normally correspond to the AC recommended by the Contractor as described in [KM 64-443](#). The evaluating authority (either the Division or DME) may adjust the recommended AC if extensive justification (such as experience with similar mixtures, an obvious error in the mixture data, etc.) is available.
- 3.11.2. If small changes are necessary which can be coordinated with the Contractor, the evaluating authority will report the JMF as acceptable "with changes" and note the required changes. The Division or DME will consider the Contractor to have accepted the changes unless a revised JMF is submitted.
- 3.11.3. When significant changes are required in the JMF (due to the failure to satisfy the applicable mix-design criteria or gradation requirements) before a satisfactory mix can be produced, the evaluating authority will report the mixture as unacceptable. In this case, the Division or DME will require the Contractor to revise and resubmit the JMF.
- 3.11.4. For new mixture designs previously unsubmitted to the Department or reference mixture designs as described in [Subsections 3.9.3.2, 3.9.3.3, or 3.9.3.4](#) of this method, the evaluating authority will return a copy of the JMF reported as acceptable to the contractor on the "Asphalt-Mixture-Design Results" form, or "MixPack" spreadsheet.

3.12. Performance Verification:

- 3.12.1. For applicable mixture classes and types, the Division or DME will evaluate the acceptability of the mixture based on laboratory performance for rutting and cracking susceptibility according to the following thresholds:

For All 0.38-inch and 0.50-inch Surface Mixtures with Performance Grade 64-22 Binder

Mix Design Performance Limits		
Class	Hamburg Passes¹ (min)	KYCT Index (min)
2	7,500	95
3	10,000	95
4	10,000	125

¹Mixture rutting resistance shall meet the above number of passes for a critical rut depth of 1/2" (12.5 mm). The "Hamburg Passes" value is determined by averaging the results from both sides of the test.

3.12.2. For new Class 2 and 3 applicable mixtures, the DME, or a Superpave Plant Technologist certified KYTC representative, shall witness a successful demonstration of adequate performance according to the thresholds in 3.12.1. The contractor must provide 48 hours notice to the Department when demonstration of mixture performance is desired and the Department must be available for demonstration. For new Class 4 mixtures, the Division of Materials shall verify the proposed mixture design performance in accordance with the JMF at the Central Office Laboratory.

3.12.3. During the mixture approval process, a single retest shall be granted for an unsuccessful demonstration or verification of asphalt mixture performance. If the retest is also unsuccessful, the contractor shall redesign the proposed JMF.

3.12.4. Once mixture design approval is granted, a contractor may reference in accordance with 3.9.3 of this method with the following exceptions: the mixture must meet the performance threshold of the higher class if a reference change is desired (i.e. must meet for a Class 3 if referencing from a Class 2) and the performance component of the mixture approval is only good for one year. Performance of a reference design must be verified each year.

3.12.5. Each applicable contract shall begin with a performance approved mixture. Given an unforeseen event during production that would require a mix design change, the contractor may switch to an unwitnessed/unverified design to finish out the contract. If that modified design is desired for additional use on any future contract, performance demonstration or verification will be required for any referencing of said design.

4. SETTING THE PLANT FOR THE JMF:

4.1. Provide a SPT to set the plant for the JMF reported as acceptable. Also, ensure the SPT is present and available at all times to perform mixture testing when producing and supplying asphalt mixtures for Department projects (according to Section 402 of the Department's *Standard Specifications for Road and Bridge Construction*).

4.2. Refer to the *SPT Training Manual* from the Division for examples of asphalt-plant-mix design.

4.3. Setup period (for all mixtures except Sand Asphalt, OGFC, and scratch course) - At the start of plant operations, provide a SPT to set the plant to meet the JMF reported as acceptable. Establish the JMF by the end of the first subplot of production for each type of mixture produced. Conform to the gradation requirements at all times unless permitted otherwise by the Division or DME.

4.4. Adjustment period ("minor changes" for Sand Asphalt, OGFC, and scratch course):

4.4.1. At the start of production, provide a SPT to set the plant to meet the JMF reported as acceptable. Establish the JMF by the end of the first subplot for each type of

mixture produced. Ensure the new JMF is within the following tolerances of the JMF reported as acceptable. The Division or DME will consider these tolerances “minor changes.” Conform to the gradation requirements unless permitted otherwise by the Division or DME.

<u>Sieve Size</u>	<u>Tolerances for New JMF From Original JMF (%)</u>
1 in.	± 4
3/4 in.	± 4
1/2 in.	± 4
3/8 in.	± 4
No. 4	± 4
No. 8	± 3
No. 16	± 3
No. 30	± 3
No. 50	± 3
No. 100	± 2
No. 200	± 1.0
Fineness Modulus*	± 0.10

*Sand Asphalt only

- 4.4.2. When desiring to produce a mixture with a JMF different than the JMF reported as acceptable, outside of the tolerances listed above, present the revised JMF to the Division or DME for evaluation by the end of the first subplot and prior to beginning the second subplot. The Division or DME may require an adjustment in the AC.
- 4.4.3. After establishing the JMF for a scratch course, conform to the gradation requirements (control points) of AASHTO M 323 for base, binder, or surface as the Engineer directs.
- 4.4.4. After establishing the JMF for an OGFC, conform to the gradation requirements and JMF tolerances given in Section 404 of the Department’s *Standard Specifications for Road and Bridge Construction*.
- 4.4.5. After establishing the JMF for a Sand Asphalt, conform to the gradation requirements given in the *Special Note for Sand Asphalt Surface*.

5. CHANGES IN THE JMF:

5.1. For Sand Asphalt, OGFC, and scratch course:

- 5.1.1. Except those outlined in [Subsection 4.4](#) of this method, make no changes in the JMF unless permitted otherwise by the Division or DME.
- 5.1.2. The Division or DME may allow JMF revisions during the course of the job.

- 5.2. For all mixtures:
- 5.2.1. When making major changes in the JMF, perform a new laboratory mix design, and submit it to the evaluating authority with all specimens, samples, and supporting information as described in [Subsection 3.9](#) of this method, if applicable.
 - 5.2.2. Requested changes: Submit changes on the appropriate “Asphalt-Mixture-Design Results” form with an explanation (the reason for the change) attached.
 - 5.2.3. Changes to maintain bin balances:
 - 5.2.3.1. Make no changes in the JMF to maintain bin balances without first assuring the Division or DME that the plant is operating properly (no holes in the screens, the screens not blinded, no carry-over, proper operation of the dust collector, proper operation of the scales and mixer, etc.).
 - 5.2.3.2. Make no changes in the JMF to maintain bin balances due to segregated or improperly handled stockpiles, or an otherwise variable aggregate gradation into the individual aggregate feeders.
 - 5.2.4. Permissible changes by the Contractor’s SPT (within the gradation requirements for the applicable mixture) without immediate notification of the Division or DME are as follows:
 - 5.2.4.1. Changing the hot-bin percentages for batch plants.
 - 5.2.4.2. Changing the cold-feed proportions, except for the specific aggregate for skid-resistant mixes.
 - 5.2.4.3. Changing the size of the cold-feed aggregates; however, do not change the sources of aggregates without prior notification of, and evaluation by, the Division or DME.
 - 5.2.5. In addition to the JMF, make no changes in the mixing temperature and times without notification of, and evaluation by, the Division or DME.
 - 5.2.5.1. The Division or DME may report a target mixing temperature on the “Asphalt-Mixture-Design Results” form and adjust this temperature during production due to the type of aggregate, coating characteristics, aggregate moisture, mixture workability and compactibility, and/or weather conditions.
 - 5.2.5.2. The Division or DME may establish a mixing time. Because the PG binder coating on the aggregate is hardened by exposure to air and heat, the mixing time should be the shortest time within specifications that provides uniform distribution of aggregate sizes and uniform coating of the aggregate by the PG binder and any additives that are utilized. The Division or DME may revise this

mixing time if insufficient coating of the aggregate or irregular AC or gradation values occur.

APPROVED

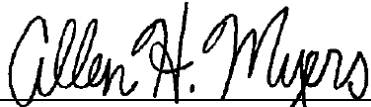

DIRECTOR
DIVISION OF MATERIALS

DATE

05/26/22

Kentucky Method 64-421-22
Revised 05/26/22
Supersedes KM 64-421-09
Dated 04/01/09

Kentucky Method 64-422-08
Revised 02/21/08
Supersedes KM 64-422-03
Dated 01/08/03

ASPHALT RELEASING AGENT

1. SCOPE: This test method covers the determination of the effectiveness of an asphalt-releasing agent for use in the beds of trucks hauling asphalt mixtures.
2. APPARATUS:
 - 2.1. Provide a flat-bottom metal pan, approximately 10 x 14 inches.
 - 2.2. Provide an oven capable of maintaining a temperature of 275 ± 10 °F.
 - 2.3. Provide an 8-oz. ointment cup.
3. MATERIALS: Provide any asphalt mixture containing a performance-graded (PG) 64-22 asphalt binder conforming to AASHTO M320, *Performance-Graded Asphalt Binder*.
4. SAMPLE REQUIREMENTS:
 - 4.1. Provide one quart of the asphalt releasing agent.
 - 4.2. Provide a minimum of 5000 g of asphalt mixture.
5. PROCEDURE:
 - 5.1. Heat the asphalt mixture in an oven to a constant temperature of 275 ± 10 °F.
 - 5.2. Coat the metal pan with the releasing agent in the concentration suggested by the manufacturer.
 - 5.3. While the pan is still wet, place the hot asphalt mixture evenly into the pan to an approximate depth of 0.5 inches. Allow the asphalt mixture to cool undisturbed for 15 minutes. Then, attempt to release the asphalt mixture from the pan by scraping it with a spatula.
6. REPORT: The Department will consider the releasing agent as acceptable if the asphalt mixture can be easily removed from the metal pan.

APPROVED

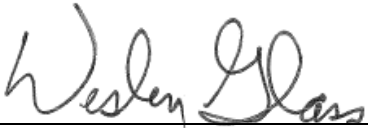

DIRECTOR
DIVISION OF MATERIALS

DATE

02/21/08

Kentucky Method 64-422-08

Revised 02/21/08

Supersedes KM 64-422-03

Dated 01/08/03

EFFECT OF WATER ON COHESION OF COMPACTED ASPHALT MIXTURES

1. SCOPE: This method covers the measurement of the change in resistance to plastic flow (Marshall stability) resulting from the action of water on compacted asphalt mixtures. Obtain a numerical index of retained resistance to plastic flow by comparing the resistance to plastic flow of specimens determined by the Marshall procedure, AASHTO T 245, Resistance to Plastic Flow of Bituminous Mixtures Using Marshall Apparatus, with that of specimens that have been immersed in water under prescribed conditions.
2. APPARATUS:
 - 2.1. Provide a water bath conforming to AASHTO T 245.
 - 2.2. Flat, glass transfer plates: Provide one plate to keep under each test specimen during the immersion period, and during handling except when testing, in order to prevent breakage or distortion of the specimens.
 - 2.3. Provide a Marshall recording-test press conforming to AASHTO T 245.
 - 2.4. Provide calipers capable of measuring up to 6 in. to the nearest 0.01 in.
3. SPECIMENS:
 - 3.1. Prepare specimens 4 inches in diameter according to AASHTO T 245, except that the number of blows shall be such to provide specimens with 7.0 ± 1.0 percent voids in the compacted mix.
 - 3.2. For open-graded friction course (OGFC), use a mix temperature as determined by [Kentucky Method \(KM\) 64-424](#), Method for Designing Open-Graded Friction Course Mixtures, for that mixture and a compactive effort of 35 blows on one side only.
 - 3.3. Control specimens: For each test, prepare three control specimens.
 - 3.4. Test specimens: For each combination to be tested, prepare three specimens.
4. PROCEDURE:
 - 4.1. Measure, and record, the height of all specimens to the nearest 0.01 in.
 - 4.2. Immerse the specimens in a water bath maintained at the temperature indicated in the following table, and allow the specimens to remain for the indicated duration.

MIXTURE TYPE	TEMPERATURE OF WATER BATH (°F)	DURATION OF IMMERSION
(TEST SPECIMENS)		
Sand Asphalt	140	24 hours
OGFC	120	96 hours
(CONTROL SPECIMENS)		
Sand Asphalt	140	30 minutes
OGFC	120	30 minutes

4.3. Remove the specimens from the bath at the end of the specified immersion period, and test them for resistance to plastic flow according to AASHTO T 245.

4.4. Correct the stability of each specimen by applying the correlation ratios, for the applicable specimen height, in Table 1 of AASHTO T 245.

5. CALCULATION: Calculate the numerical index of the resistance, R_r , of the asphalt mixture to the effect of water as the percentage of the original resistance to plastic flow that is retained after the immersion period as follows:

$$R_r = 100 (S_2/S_1),$$

where: S_2 = average of the maximum load in lb_f of the three test specimens; and
 S_1 = average of the maximum load in lb_f of the three control specimens.

6. REPORT: Report R_r to the nearest percent. Consider values less than 70 percent unsatisfactory.

APPROVED

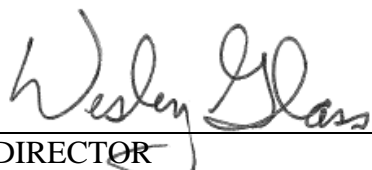

 DIRECTOR
 DIVISION OF MATERIALS

DATE

02/21/08

Kentucky Method 64-423-08
 Revised 02/21/08
 Supersedes KM 64-423-03
 Dated 01/10/03

METHOD FOR DESIGNING OPEN-GRADED FRICTION COURSE MIXTURES

1. SCOPE:

- 1.1. This method describes the procedure for the design of Open-Graded Friction Course (OGFC) mixtures. This method is based on, and similar to, the [Federal Highway Administration \(FHWA\) Technical Advisory T 5040.31](#).
- 1.2. The proper completion of the instructions given in this procedure will result in the determination of the asphalt binder content (AC), mixing temperature, air void content, and moisture susceptibility of a given OGFC mixture.
- 1.3. Refer to the attachments at the end of this method for: (1) [a blank worksheet](#); (2) [a completed example of the design of an OGFC mixture containing aggregate with "normal" absorptive properties](#); and (3) [a completed example of the design of an OGFC mixture containing aggregate with "high" absorptive properties](#) (see [Subsection 4.1.3](#) of this method for a definition).

2. APPARATUS:

- 2.1. Provide the equipment required to perform a sieve analysis in accordance with [Kentucky Method \(KM\) 64-620](#), Wet Sieve Analysis of Fine and Coarse Aggregate.
- 2.2. Provide the equipment required to perform aggregate specific gravity determinations in accordance with AASHTO T 84, Specific Gravity and Absorption of Fine Aggregate, and AASHTO T 85, Specific Gravity and Absorption of Coarse Aggregate.
- 2.3. Provide the following equipment and materials that are necessary for determining the surface capacity of the predominant aggregate fraction (passing the 3/8-in. sieve and retained on the No. 4 sieve):
 - 2.3.1. Provide a metal funnel having a top diameter of 3.5 in., a height of 4.5 in., an orifice diameter of 0.5 in., and having a No. 10 sieve fastened to the bottom orifice.
 - 2.3.2. Provide one quart of a SAE No. 10 lubricating oil.
- 2.4. Provide the following equipment that is necessary to determine the void capacity of the predominant-aggregate fraction:
 - 2.4.1. Provide a compaction mold conforming to the following: a 6-in.-nominal diameter, solid-wall, metal cylinder with a detachable, metal base plate, as shown in Figure 1. Also provide a detachable, metal guide-reference bar.
 - 2.4.2. Provide a portable, electromagnetic vibrating rammer, as shown in Figure 2, having a

frequency of 3600 cycles per minute, suitable for use with 115-volt alternating current. Also provide a tamper foot and extension on the rammer, as shown in Figure 3.

- 2.4.3. Provide a wooden base consisting of a plywood disc, 15 in. in diameter, 2 in. thick, with a cushion (rubber hose) attached to the bottom. Construct the disc so it can be firmly attached to the base plate of the compaction mold.
- 2.4.4. Provide a stopwatch or other timing device graduated in divisions of 1.0 second, accurate to 1.0 second, and capable of timing the unit for up to 30 minutes. As an option, use an electric timing device or electrical circuits to start and stop the vibratory compactor.
- 2.4.5. Provide a dial indicator, graduated in 0.001-in. increments, with a travel range of 3.0 in.

3. PRELIMINARY AGGREGATE WORK:

- 3.1. Refer to [KM 64-411](#), Preparing Ingredient Materials for, and Performing, a Laboratory Mix Design of an Asphalt Mixture, for the initial preparation and gradation of the aggregate(s).
- 3.2. Determine the apparent specific gravity for the predominant-aggregate fraction for each size and type of material to be utilized. Then, determine the bulk specific gravity for the coarse- (retained on the No. 8 sieve) and fine- (passing the No. 8 sieve) aggregate fractions for each size and type of material to be utilized. Perform all aggregate specific gravity determinations in accordance with AASHTO T 84 and T 85.
 - 3.2.1. Given the proposed proportions of aggregates as determined and verified in Subsection 3.1 of this method, mathematically compute the apparent specific gravity of the predominant-aggregate fraction.
 - 3.2.2. Given the proposed proportions of aggregates as determined and verified in Subsection 3.1 of this method, mathematically compute the bulk specific gravity for the coarse- and fine-aggregate fractions.
 - 3.2.3. Given the proposed proportions of aggregates as determined and verified in Subsection 3.1 of this method, calculate the combined bulk specific gravity of the aggregate, G_{sb} , as described in the MS-2 Manual, *Mix Design Methods for Asphalt Concrete and Other Hot-Mix Types*, from the [Asphalt Institute](#).
 - 3.2.4. If the bulk specific gravities of the aggregate sources are significantly different, a gradation analysis based on aggregate weight will not reflect the actual particle-size distribution. In this case, re-examine the gradation of the aggregate blend on a volume basis for compliance with the applicable specifications.

4. DETERMINATION OF AC:

- 4.1. Determine the surface capacity of the predominant-aggregate fraction in accordance with the following procedure (complete this procedure three times to obtain an average):

KM 64-424-08

- 4.1.1. "Quarter out" a minimum of 105 g of the predominant aggregate. Dry the sample to a constant weight in an oven at 230 ± 9 °F. Allow the sample to cool to room temperature.
- 4.1.2. Reduce the sample to 100.0 ± 1.0 g, and place the sample in a metal funnel (described in [Subsection 2.3.1](#) of this method). Record the weight of the predominant-aggregate sample as "A."
- 4.1.3. Completely immerse the specimen in SAE No. 10 lubricating oil for five minutes at room temperature. If using highly absorptive aggregate, immerse the specimen for 30 minutes. For the purposes of this method, consider an OGFC mixture to contain highly absorptive aggregate if the combined water absorption of the individual aggregates comprising the mixture is greater than 3.5 %.
- 4.1.4. Drain the sample in the funnel for two minutes. Place the funnel containing the sample in an oven at 140 ± 5 °F for 15 minutes of additional drainage.
- 4.1.5. Pour the sample from the funnel into a tared pan; cool to room temperature, and weigh the sample to the nearest 0.1 g. Record this weight as "B."
- 4.1.6. Compute the percentage of retained oil, P_{ro} , using the following formula:

$$P_{ro} = 100 \left[\frac{G_{sa} (B - A)}{2.65 A} \right], \text{ where}$$

P_{ro} = the percentage of retained oil;
 G_{sa} = the apparent specific gravity of the predominant aggregate (as calculated in Subsection 3.2.1 of this method);
 A = the oven-dry weight of the sample (g); and
 B = the coated weight of the sample (g).

- 4.1.7. When performing this procedure with highly absorptive aggregate, perform the following additional steps to determine an "adjusted" value for P_{ro} .
 - 4.1.7.1. After determining "B" as described in Subsection 4.1.5 of this method, pour the sample onto a clean, dry cloth and achieve a saturated, surface-dry condition.
 - 4.1.7.2. Pour the sample from the cloth into a tared pan, and weigh the sample to the nearest 0.1 g. Record this weight as "C."
 - 4.1.7.3. Compute the percentage of absorbed oil, P_{ao} , using the following formula:

$$P_{ao} = 100 \left(\frac{C - A}{A} \right), \text{ where}$$

P_{ao} = the percentage of absorbed oil;
 C = the saturated, surface-dry weight of the sample (g); and
 A = the oven-dry weight of the sample (g).

4.1.7.4. Determine the "adjusted" percentage of retained oil, P_{roa} , using the following formula:

$$P_{roa} = P_{ro} - P_{ao}, \text{ where}$$

P_{roa} = the adjusted percentage of retained oil;
 P_{ro} = the percentage of retained oil; and
 P_{ao} = the percentage of absorbed oil.

4.1.8. Calculate the surface constant value, K_c , for the predominant aggregate using the following formula:

$$K_c = 0.1 + 0.4 P_{ro}, \text{ where}$$

K_c = the surface constant of the predominant aggregate; and
 P_{ro} = the percentage of retained oil.

When performing this procedure with highly absorptive aggregate, use this formula for determining the "adjusted" surface constant, K_{ca} :

$$K_{ca} = 0.1 + 0.4 P_{roa}, \text{ where}$$

K_{ca} = the adjusted surface constant of the predominant aggregate; and
 P_{roa} = the adjusted percentage of retained oil.

4.2. Calculate the required asphalt content, AC_{req} , based on the weight of total aggregate, using the following formula:

$$AC_{req} = \frac{2.65(2K_c + 4)}{G_{sa}}, \text{ where}$$

AC_{req} = the required AC (%);
 K_c = the surface constant of the predominant aggregate (as calculated in Subsection 4.1.8 of this method); and
 G_{sa} = the apparent specific gravity of the predominant aggregate (as calculated in [Subsection 3.2.1](#) of this method).

4.3. When performing this procedure with highly absorptive aggregate, the formula for determining the effective asphalt content, Eff. AC, is:

$$Eff. AC = \frac{2.65(2K_{ca} + 4)}{G_{sa}}, \text{ where}$$

Eff. AC = the effective asphalt content (%);

K_{ca} = the adjusted surface constant of the predominant aggregate (as calculated in Subsection 4.1.8 of this method); and

G_{sa} = the apparent specific gravity of the predominant aggregate (as calculated in [Subsection 3.2.1](#) of this method).

4.4. When performing this procedure with highly absorptive aggregate, complete Sections 5 and 6, and then continue with the determination of the AC as follows:

4.4.1. Prepare three trial mixtures using an AC equal to, or somewhat greater than (estimate the amount that will be absorbed), the effective asphalt content, Eff. AC, as determined in [Subsection 4.3](#) of this method, and using the aggregate gradation, as determined in [Subsection 6.2](#) of this method.

4.4.2. In accordance with AASHTO T 209, Theoretical Maximum Specific Gravity and Density of Bituminous Paving Mixtures, determine the theoretical maximum specific gravity, G_{mm} , of each trial mixture. Include the Supplemental Procedure for Mixtures Containing Porous Aggregate in AASHTO T 209. Average the results of the three trial mixtures.

4.4.3. In accordance with the MS-2 Manual, calculate the effective specific gravity of the aggregate, G_{se} , using the AC from [Subsection 4.3](#) of this method.

4.4.4. In accordance with the MS-2 Manual, calculate the percent of absorbed asphalt, by weight of total aggregate, Abs. AC, using G_{sb} as determined in [Subsection 3.2.3](#) of this method.

4.4.5. Determine the AC_{req} of the absorptive mixture using the following formula:

$$AC_{req} = Eff. AC + Abs. AC, \text{ where}$$

AC_{req} = the required AC (%);

Eff. AC = the effective AC (%), as calculated in [Subsection 4.3](#) of this method; and

Abs. AC = the absorbed AC, by weight of total aggregate (%), as calculated in [Subsection 4.4.4](#) of this method.

5. VIBRATED UNIT WEIGHT AND VOID CAPACITY OF COARSE AGGREGATE:

5.1. Determine the vibrated unit weight of the coarse-aggregate fraction of the proposed JMF.

5.1.1. "Weigh-up" a sample of the coarse-aggregate fraction (approximately 5 lb_m) from the proposed JMF. If the bulk specific gravity of the coarse aggregate is less than 2.000, reduce the size of the sample to approximately 3.5 lb_m. Weigh the sample to the nearest 0.1 lb_m. Record this weight as "W."

- 5.1.2. Pour the sample into the compaction mold, and place the tamper foot on the sample. Place the guide-reference bar over the shaft of the tamper foot, and secure the bar to the mold with the thumb screws.
- 5.1.3. Place the vibratory rammer on the shaft of the tamper foot, and vibrate for 15 seconds. During the vibration period, exert just enough pressure on the hammer to maintain contact between the sample and the tamper foot. Practice operating the vibratory rammer and maintaining pressure on the hammer prior to actually performing this process.
- 5.1.4. In order to obtain the thickness of the compacted material, t , the height of the mold wall (from top to bottom) must be determined to the nearest 0.01 in. After the 15-second vibration period described in Subsection 5.1.3 of this method, remove the vibratory rammer from the shaft of the tamper foot, and brush any fines from the top of the tamper foot. Then, measure the distance from the top of the mold to the layer of compacted material to the nearest 0.01 in. in at least three different locations around the circumference of the mold, and average these values. The difference between this averaged value and the height of the empty mold is the thickness of the compacted material, t .
- 5.1.5. Calculate the vibrated unit weight of the coarse-aggregate fraction, U_v , as follows:

$$U_v = \frac{6912W}{\pi d^2 t}, \text{ where}$$

U_v = the vibrated unit weight of the coarse-aggregate fraction (lb_m/ft^3);
 W = the weight of the coarse-aggregate fraction (lb_m);
 D = the diameter of the compaction mold (in.) = 6 in.; and
 T = the thickness of the vibrated material (in.).

If $W = 5 \text{ lb}_m$, use the following simplified formula:

$$U_v = \frac{305.73}{t}$$

- 5.2. Calculate the void capacity of the coarse-aggregate fraction, V_c , as a percent of the total volume, using the following formula:

$$V_c = 100 \left(1 - \frac{U_v}{U_c} \right), \text{ where}$$

V_c = the void capacity of the coarse-aggregate fraction (%);
 U_v = the vibrated unit weight of the coarse-aggregate fraction (lb_m/ft^3) as calculated in Subsection 5.1.5 of this method; and
 U_c = the bulk-dry solid unit weight of the coarse-aggregate fraction (lb_m/ft^3) = the bulk specific gravity of the coarse-aggregate fraction multiplied by 62.4.

- 5.3. Complete Subsections 5.1 and 5.2 of this method three times to obtain average values for U_v

and V_c , respectively.

6. OPTIMUM CONTENT OF FINE AGGREGATE:

6.1. Calculate the optimum-fine-aggregate content, F , with the following formula:

$$F = \frac{V_c - V - \frac{AC_{req} U_v}{U_a}}{\frac{V_c - V}{100} + \frac{U_v}{U_f}}, \text{ where}$$

F = the optimum-fine-aggregate content by weight of the total aggregate (%);

V_c = the void capacity of the coarse-aggregate fraction (%) as calculated in [Subsection 5.3](#) of this method;

V = the design air void content (%) = 15.0 %;

AC_{req} = the required AC (%), when using this procedure for highly absorptive aggregate, use Eff. AC from [Subsection 4.3](#) of this method, not AC_{req} ;

U_v = the vibrated unit weight of the coarse-aggregate fraction (lb_m/ft^3) as calculated in [Subsection 5.3](#) of this method;

U_a = the unit weight of the asphalt binder = 64.272 lb_m/ft^3 ; and

U_f = the bulk-dry solid unit weight of the fine-aggregate fraction (lb_m/ft^3) = the bulk specific gravity of the fine-aggregate fraction multiplied by 62.4.

6.2. Compare the optimum-fine-aggregate content, F , determined in Subsection 6.1 of this method, to the amount passing the No. 8 sieve of the proposed JMF. If these values differ by more than one percent, revise the JMF using the value determined for the optimum fine-aggregate content. Recalculate the proportions of coarse and fine aggregates to meet the revised JMF. If the proposed and revised JMF gradations are significantly different, it may be necessary to perform portions of this procedure again.

7. DETERMINATION OF MIXING TEMPERATURE:

7.1. Prepare a sample of aggregate (approximately 1000 g) in the proportions determined in Subsection 6.2 of this method. As a "starting point," mix this sample with the asphalt binder at the AC determined in [Subsection 4.2](#) of this method (or [Subsection 4.4.5](#) of this method when using highly absorptive aggregate) at a mixing temperature of 225 °F for performance-graded (PG) 64-22 asphalt binder, 240 °F for PG 70-22, and 265 °F for PG 76-22. When the aggregate is completely coated, transfer the mixture to a Pyrex glass plate (8 - 9 in. in diameter), and spread the mixture with a minimum of manipulation.

7.02 Place the plate, with the sample, in the oven at the mixing temperature. Observe the bottom of the plate after 60 minutes. A slight puddle of asphalt binder at the points of contact between the aggregate and the glass plate, as shown in Case (2) of Figure 4, is suitable and desirable after the 60-minute period. Otherwise, repeat the test at a higher or lower mixing temperature to achieve the desired contact area. If asphalt drainage occurs at a mixing temperature that is too low to provide for adequate drying of the aggregate (typically not lower than 225 °F), use an asphalt binder of a higher viscosity.

Figure 4. "Drain-Down" Characteristics.

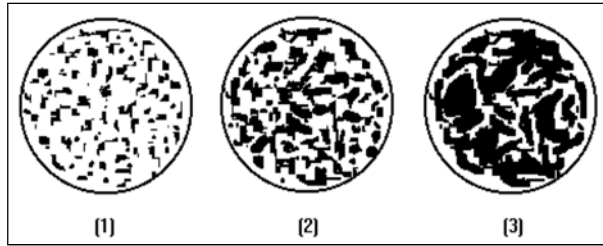

- (1) Little "drain-down;" increase the mixing temperature.
- (2) Desired "drain-down;" optimum mixing temperature.
- (3) Excessive "drain-down;" decrease the mixing temperature.

7.3. Make an intermediate observation of the plate after 15 minutes. If excessive "drain-down" occurs at the contact points after 15 minutes, discard the sample, and repeat the test at a lower temperature.

8. DETERMINATION OF RESISTANCE TO EFFECTS OF WATER:

8.1. Complete [KM 64-423](#), Effect of Water on Cohesion of Compacted Asphalt Mixtures, on the designed mixture.

8.2. As directed by the Department, use liquid anti-stripping additives that provide adequate retained strength.

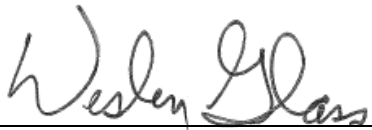
APPROVED 

DIRECTOR
DIVISION OF MATERIALS

DATE 02/21/08

Kentucky Method 64-424-08
Revised 02/21/08
Supersedes KM 64-424-03
Dated 01/10/03

Attachments

Kentucky Transportation Cabinet, Department of Highways, Division of Materials
 Asphalt Mixtures Testing Section
 1227 Wilkinson Boulevard, Frankfort, KY 40601-1226

OPEN-GRADED FRICTION COURSE (OGFC) MIX-DESIGN WORKSHEET

Mix ID # & County: _____

Tested By: _____

Date Received: _____

Date Completed: _____

Test Method(s) Used: KM 64-424 & KM 64-423

Lab: 000

1. MATERIAL PROPERTIES

A. Proposed Job-Mix Formula (JMF)

Sieve Size	Individual Gradations				Proposed JMF	Specification Limits
	Agg. # 1	Agg. # 2	Agg. # 3	Agg. # 4		
1/2 in.						100
3/8 in.						90 - 100
No. 4						25 - 50
No. 8						5 - 15
No. 200						2.0 - 5.0

B. Proposed Aggregate Proportions and Specific Gravities

Agg. #	Agg. Type & Size	Percent	G ₂₀₀ (Predom. Agg.)	G ₂₀₀ (Coarse Agg.)	G ₂₀₀ (Fine Agg.)
1					
2					
3					
4					
Combined Totals		100			
Bulk-Dry Solid Unit Weight (lb _m /ft ³)				U _c =	U _f =
Combined G ₂₀₀ of Total Aggregate					

Predominant Aggregate = Passing 3/8-in. sieve and retained on No. 4 sieve.
 Coarse Aggregate = Retained on No. 8 sieve.
 Fine Aggregate = Passing No. 8 sieve.

C. Asphalt Properties

Unit Weight (64.272 lb_m/ft³) _____

2. ASPHALT CONTENT

A. Aggregate With "Normal" Absorptive Properties

Sample Property	Test # 1	Test # 2	Test # 3	Average
Sample Weight, Dry, A (g)				
Sample Weight, After Submersion, B (g)				
Retained Oil, P _{ro} (%)				
Surface Constant, K _c				
Required Asphalt Content, AC _{req} (%), by Weight of Total Aggregate				

B. Aggregate With "High" Absorptive Properties

Sample Property	Test # 1	Test # 2	Test # 3	Average
Sample Weight, Dry, A (g)				
Sample Weight, After Submersion, B (g)				
Retained Oil, P _{ro} (%)				
Sample Weight, SSD, C (g)				
Absorbed Oil, P _{ao} (%)				
Retained Oil, Adjusted, P _{roa} (%)				
Adjusted Surface Constant, K _{ca}				
Effective Asphalt Content, E ff. AC (%)				

Note: Complete Sections 5 and 6 in KM 64-424, then continue AC determination.

Sample Property	Test # 1	Test # 2	Test # 3	Average
G _{mm} of Trial Mixtures				
Effective Specific Gravity of Agg., G _{se}				
Absorbed Asphalt (Agg.), Abs. AC (%)				
Required Asphalt Content, AC _{req} (%), by Weight of Total Aggregate				

3. VIBRATED UNIT WEIGHT AND VOID CAPACITY OF COARSE AGGREGATE

Sample Property	Test # 1	Test # 2	Test # 3	Average
Sample Weight, W (lb _m)				
Thickness of Compacted Material, t (in.)				
Vibrated Unit Weight, U _v (lb _m /ft ³)				
Void Capacity, V _c (%)				

4. OPTIMUM-FINE-AGGREGATE CONTENT

Optimum-Fine-Aggregate Content, F (%) _____

Note: When determining F for aggregate with "high" absorptive properties, use E ff. AC in formula, not AC_{req}. Compare F to proposed JMF on No. 8 sieve. If different by more than 1 %, revise JMF on No. 8 sieve to F, and recalculate other sieves accordingly.

5. OPTIMUM MIXING TEMPERATURE

Trial Temperature (°F)	Observed Drainage

Performance-Graded (PG) Binder _____

Target Mixing Temperature (°F) _____

6. RESISTANCE TO EFFECTS OF WATER (KM 64-423)

Average Load of Control Specimens, S₁ (lb_r) _____

Average Load of Test Specimens, S₂ (lb_r) _____

Resistance to Effects of Water, R_r (%) _____ (70 %, minimum)

7. MIX-DESIGN SUMMARY

Sieve Size	Specification Limits	Revised JMF
1/2 in.	100	
3/8 in.	90 - 100	
No. 4	25 - 50	
No. 8	5 - 15	
No. 200	2.0 - 5.0	

PG Binder _____
 Percent and Type of Additive _____
 Required AC _____ % , by weight of aggregate, AC_{req}
 _____ % , by weight of mix
 Mixing Temperature Range _____ to _____ °F

8. DEVIATIONS FROM TEST METHOD

9. MIX-DESIGN RECOMMENDATIONS

Accepted _____ Rejected _____

Kentucky Transportation Cabinet, Department of Highways, Division of Materials
 Asphalt Mixtures Testing Section
 1227 Wilkinson Boulevard, Frankfort, KY 40601-1226

OPEN-GRADED FRICTION COURSE (OGFC) MIX-DESIGN WORKSHEET

Mix ID # & County: # 375, Remington Co.
 Date Received: February 12, 1999
 Test Method(s) Used: KM 64-424 & KM 64-423

Tested By: B. Dance
 Date Completed: February 28, 1999
 Lab: 000

1. MATERIAL PROPERTIES

A. Proposed Job-Mix Formula (JMF)

Sieve Size	Individual Gradations				Proposed JMF	Specification Limits
	Agg. # 1	Agg. # 2	Agg. # 3	Agg. # 4		
1/2 in.	100	100			100	100
3/8 in.	90	100			92	90 - 100
No. 4	20	82			32	25 - 50
No. 8	2	55			13	5 - 15
No. 200	1.5	13.5			4.0	2.0 - 5.0

B. Proposed Aggregate Proportions and Specific Gravities

Agg. #	Agg. Type & Size	Percent	G _{ss} (Predom. Agg.)	G ₂₀ (Coarse Agg.)	G ₂₀ (Fine Agg.)
1	Granite # 8's	80	2.710	2.659	2.632
2	Limestone Sand	20	2.698	2.649	2.644
3					
4					
Combined Totals		100	2.708	2.657	2.634
Bulk-Dry Solid Unit Weight (lb _m /ft ³)				U _c = 165.8	U _f = 164.4
Combined G ₂₀ of Total Aggregate				2.656	

Predominant Aggregate = Passing 3/8-in. sieve and retained on No. 4 sieve.
 Coarse Aggregate = Retained on No. 8 sieve.
 Fine Aggregate = Passing No. 8 sieve.

C. Asphalt Properties

Unit Weight (64.272 lb_m/ft³) 64.272

2. ASPHALT CONTENT

A. Aggregate With "Normal" Absorptive Properties

Sample Property	Test # 1	Test # 2	Test # 3	Average
Sample Weight, Dry, A (g)	100.0	100.1	99.9	
Sample Weight, After Submersion, B (g)	102.1	102.3	102.2	
Retained Oil, P _{ro} (%)	2.15	2.25	2.35	
Surface Constant, K _c	0.96	1.00	1.04	
Required Asphalt Content, AC _{req} (%), by Weight of Total Aggregate	5.8	5.9	6.0	5.9

B. Aggregate With "High" Absorptive Properties

Sample Property	Test # 1	Test # 2	Test # 3	Average
Sample Weight, Dry, A (g)				
Sample Weight, After Submersion, B (g)				
Retained Oil, P _{ro} (%)				
Sample Weight, SSD, C (g)				
Absorbed Oil, P _{ao} (%)				
Retained Oil, Adjusted, P _{roa} (%)				
Adjusted Surface Constant, K _{ca}				
Effective Asphalt Content, E ff. AC (%)				

Note: Complete Sections 5 and 6 in KM 64-424, then continue AC determination.

Sample Property	Test # 1	Test # 2	Test # 3	Average
G _{mm} of Trial Mixtures				
Effective Specific Gravity of Agg., G _{se}				
Absorbed Asphalt (Agg.), Abs. AC (%)				
Required Asphalt Content, AC _{req} (%), by Weight of Total Aggregate				

3. VIBRATED UNIT WEIGHT AND VOID CAPACITY OF COARSE AGGREGATE

Sample Property	Test # 1	Test # 2	Test # 3	Average
Sample Weight, W (lb _m)	5	5	5	
Thickness of Compacted Material, t (in.)	2.88	2.83	2.86	
Vibrated Unit Weight, U _v (lb _m /ft ³)	106.2	108.0	106.9	107.0
Void Capacity, V _c (%)	36.1	35.0	35.5	35.5

4. OPTIMUM-FINE-AGGREGATE CONTENT

Optimum-Fine-Aggregate Content, F (%) 13

Note: When determining F for aggregate with "high" absorptive properties, use E ff. AC in formula, not AC_{req}. Compare F to proposed JMF on No. 8 sieve. If different by more than 1 %, revise JMF on No. 8 sieve to F, and recalculate other sieves accordingly.

5. OPTIMUM MIXING TEMPERATURE

Trial Temperature (°F)	Observed Drainage
210	None
250	Little
285	Excessive
260	Desired

Performance-Graded (PG) Binder PG 64-22

Target Mixing Temperature (°F) 260

6. RESISTANCE TO EFFECTS OF WATER (KM 64-423)

Average Load of Control Specimens, S₁ (lb_r) 678

Average Load of Test Specimens, S₂ (lb_r) 592

Resistance to Effects of Water, R_r (%) 87 (70 %, minimum)

7. MIX-DESIGN SUMMARY

Sieve Size	Specification Limits	Revised JMF
1/2 in.	100	100
3/8 in.	90 - 100	92
No. 4	25 - 50	32
No. 8	5 - 15	13
No. 200	2.0 - 5.0	4.0

PG Binder PG 64-22
 Percent and Type of Additive 0.5 % Pave Bond Lite
 Required Asphalt Content 5.9 % , by weight of aggregate, AC_{req}
5.6 % , by weight of mix
 Mixing Temperature Range 250 to 270 °F

8. DEVIATIONS FROM TEST METHOD

Vibrating rammer remained on Sample # 2 for 17 seconds.

9. MIX-DESIGN RECOMMENDATIONS

Accepted X Rejected _____

Kentucky Transportation Cabinet, Department of Highways, Division of Materials
 Asphalt Mixtures Testing Section
 1227 Wilkinson Boulevard, Frankfort, KY 40601-1226

OPEN-GRADED FRICTION COURSE (OGFC) MIX-DESIGN WORKSHEET

Mix ID # & County: # 375, Remington Co.
 Date Received: February 12, 1999
 Test Method(s) Used: KM 64-424 & KM 64-423

Tested By: B. Dance
 Date Completed: February 28, 1999
 Lab: 000

1. MATERIAL PROPERTIES

A. Proposed Job-Mix Formula (JMF)

Sieve Size	Individual Gradations				Proposed JMF	Specification Limits
	Agg. # 1	Agg. # 2	Agg. # 3	Agg. # 4		
1/2 in.	100	100			100	100
3/8 in.	90	100			92	90 - 100
No. 4	20	82			32	25 - 50
No. 8	2	55			13	5 - 15
No. 200	1.5	13.5			4.0	2.0 - 5.0

B. Proposed Aggregate Proportions and Specific Gravities

Agg. #	Agg. Type & Size	Percent	G _{ss} (Predom. Agg.)	G ₂₀ (Coarse Agg.)	G ₂₀ (Fine Agg.)
1	Granite # 8's	80	2.710	2.659	2.632
2	Limestone Sand	20	2.698	2.649	2.644
3					
4					
Combined Totals		100	2.708	2.657	2.634
Bulk-Dry Solid Unit Weight (lb _m /ft ³)				U _c = 165.8	U _f = 164.4
Combined G ₂₀ of Total Aggregate				2.656	

Predominant Aggregate = Passing 3/8-in. sieve and retained on No. 4 sieve.
 Coarse Aggregate = Retained on No. 8 sieve.
 Fine Aggregate = Passing No. 8 sieve.

C. Asphalt Properties

Unit Weight (64.272 lb_m/ft³)

64.272

2. ASPHALT CONTENT

A. Aggregate With "Normal" Absorptive Properties

Sample Property	Test # 1	Test # 2	Test # 3	Average
Sample Weight, Dry, A (g)				
Sample Weight, After Submersion, B (g)				
Retained Oil, P _{ro} (%)				
Surface Constant, K _c				
Required Asphalt Content, AC _{req} (%), by Weight of Total Aggregate				

B. Aggregate With "High" Absorptive Properties

Sample Property	Test # 1	Test # 2	Test # 3	Average
Sample Weight, Dry, A (g)	100.0	100.1	99.9	
Sample Weight, After Submersion, B (g)	102.1	102.3	102.2	
Retained Oil, P _{ro} (%)	2.15	2.25	2.35	
Sample Weight, SSD, C (g)	101.1	101.0	101.0	
Absorbed Oil, P _{ao} (%)	1.10	0.90	1.10	
Retained Oil, Adjusted, P _{roa} (%)	1.05	1.35	1.25	
Adjusted Surface Constant, K _{ca}	0.52	0.64	0.60	
Effective Asphalt Content, E ff. AC (%)	4.9	5.2	5.1	5.1

Note: Complete Sections 5 and 6 in KM 64-424, then continue AC determination.

Sample Property	Test # 1	Test # 2	Test # 3	Average
G _{mm} of Trial Mixtures (@ 6.2 % AC)	2.500	2.503	2.502	2.502
Effective Specific Gravity of Agg., G _{se}				2.763
Absorbed Asphalt (Agg.), Abs. AC (%)				1.50
Required Asphalt Content, AC _{req} (%), by Weight of Total Aggregate				6.6

3. VIBRATED UNIT WEIGHT AND VOID CAPACITY OF COARSE AGGREGATE

Sample Property	Test # 1	Test # 2	Test # 3	Average
Sample Weight, W (lb _m)	5	5	5	
Thickness of Compacted Material, t (in.)	2.88	2.83	2.86	
Vibrated Unit Weight, U _v (lb _m /ft ³)	106.2	108.0	106.9	107.0
Void Capacity, V _c (%)	36.1	35.0	35.5	35.5

4. OPTIMUM-FINE-AGGREGATE CONTENT

Optimum-Fine-Aggregate Content, F (%) 14

Note: When determining F for aggregate with "high" absorptive properties, use E ff. AC in formula, not AC_{req}. Compare F to proposed JMF on No. 8 sieve. If different by more than 1 %, revise JMF on No. 8 sieve to F, and recalculate other sieves accordingly.

5. OPTIMUM MIXING TEMPERATURE

Trial Temperature (°F)	Observed Drainage
195	None
230	Little
265	Excessive
240	Desired

Performance-Graded (PG) Binder PG 64-22

Target Mixing Temperature (°F) 240

6. RESISTANCE TO EFFECTS OF WATER (KM 64-423)

Average Load of Control Specimens, S₁ (lb_r) 679

Average Load of Test Specimens, S₂ (lb_r) 569

Resistance to Effects of Water, R, (%) 84 (70 %, minimum)

7. MIX-DESIGN SUMMARY

Sieve Size	Specification Limits	Revised JMF
1/2 in.	100	100
3/8 in.	90 - 100	92
No. 4	25 - 50	32
No. 8	5 - 15	13
No. 200	2.0 - 5.0	4.0

PG Binder PG 64-22
 Percent and Type of Additive 0.5 % Pave Bond Lite
 Required Asphalt Content 6.6 % , by weight of aggregate, AC_{req}
6.1 % , by weight of mix
 Mixing Temperature Range 230 to 250 °F

8. DEVIATIONS FROM TEST METHOD

Vibrating rammer remained on Sample # 2 for 17 seconds.

9. MIX-DESIGN RECOMMENDATIONS

Accepted X Rejected _____

SAMPLING ASPHALT MIXTURES

1. SCOPE - This method covers the procedures for sampling asphalt mixtures. Conform to the chart in [Subsection 5.2.2](#) of this method listing the required minimum sample sizes.

NOTE 1: SAMPLING IS AS IMPORTANT AS TESTING. TAKE EVERY PRECAUTION TO OBTAIN A REPRESENTATIVE SAMPLE. DO NOT TEST A SAMPLE THAT IS NOT REPRESENTATIVE OF THE BULK MATERIAL.

2. APPARATUS AND MATERIALS – Provide the following:
 - 2.1. A square-ended shovel, at least five inches wide.
 - 2.2. A large scoop.
 - 2.3. A large pan.
 - 2.4. A surface for quartering the sample.
 - 2.5. A spatula or other quartering instrument.
 - 2.6. A marker (for identification).
3. SAMPLING LOCATION - Normally, obtain samples from the truck bed at the plant site. However, the Department does reserve the right, when unusual circumstances are encountered or the results of testing indicate the need for further testing, to sample at any point.
4. SAMPLING PROCEDURE -
 - 4.1. Prior to obtaining the sample from the truck bed or other sampling site, carefully inspect the uniformity of the material. In order to adequately represent the lot of material, obtain sample portions from three or more locations over the truck load or other sampling location. Obtain enough portions to provide a sample of adequate size for all required testing and to accurately represent all observed conditions within the load.
 - 4.2. Obtain each portion by digging approximately 12 inches into the pile of mixture, then inserting the shovel at an angle, and removing the sample. Place each portion into a large pan.
5. OBTAINING THE TEST PORTION -
 - 5.1. Conform to the following means of obtaining, and the size of, the test portion:
 - 5.2. When the mixture is to be tested according to [Kentucky Method \(KM\) 64-405](#), *Extraction of Binder From Asphalt Paving Mixtures*, obtain the test portion by first mixing the total sample thoroughly, then removing a portion for testing by quartering.
 - 5.2.1. Place the field sample on a hard, clean, smooth, level surface where there will be neither loss of material nor the accidental addition of foreign material. Mix the material thoroughly by blending the entire sample. Place the entire sample into a

conical pile by depositing material on top of itself. Flatten the conical pile to a uniform thickness and diameter by pressing down the apex with a shovel or tool. Divide the flattened mass into four equal quarters with a shovel or tool, and push aside two diagonally-opposite quarters, including the fine material. Successively mix and quarter the remaining material until the sample is reduced to the required test portion. Retain the remaining portions (quarters), and identify the truck number, time and date the sample was taken, and the project number, for further testing if necessary.

5.2.2 Conform to the following minimum sizes for testing according to [KM 64-405](#):

<u>Mixture Types</u>	<u>Minimum Weight (g)</u>
Sand Asphalt	1000
Open-Graded Friction Course, Asphalt Wedge Curbs and Mountable Medians, and 0.38-inch nominal-maximum	1500
Asphalt-Treated Drainage Blanket and 0.5-inch nominal-maximum	2000
Asphalt Mixture for Pavement Wedge and 0.75-inch nominal-maximum	3000*
1.0-inch and 1.5-inch nominal-maximum	5000*

* When the capacity of the extraction apparatus is not sufficient for the quantity indicated, subdivide the test portion. Separately test the two or more resulting portions, and combine the results, as a weighted average, to constitute one test.

These values are minimum sizes only. When obtaining the test portion for an extraction acceptance test, do not manipulate the sample such that it weighs exactly the specified minimum weight. Use the sample weight of the quarter obtained, providing it meets the required minimum.

5.3 When the mixture is to be tested according to [KM 64-437](#), *Determination of Asphalt Binder Content of Asphalt Mixtures Using the Nuclear Asphalt Content Gauge*, obtain the field sample according to [Subsections 4.1 and 4.2](#) of this method.

Obtain the test portion as follows. Mix the sample thoroughly by blending the entire field sample. Take extreme care to uniformly blend all of the material. Then, using a scoop, select representative portions of the mixture until the quantity of material described in [KM 64-437](#) is obtained.

5.4. When the mixture is to be tested according to [KM 64-435](#), *Method for Acceptance of Asphalt Mixtures by Mixture Property Analysis*, obtain the field sample according to [Subsections 4.1 and 4.2](#) of this method.

Obtain the test portion as described in Subsection 5.3 of this method. Ensure the test portion quantities comply with the amounts required in AASHTO T 312, *Determining the Density of Hot-Mix Asphalt (HMA) Specimens by Means of the Superpave Gyrotory Compactor*, for gyrotory specimens, and AASHTO T 209, *Theoretical Maximum Specific Gravity and Density of Bituminous Paving Mixtures*, for maximum-specific-gravity (G_{mm}) samples.

5.5. When the mixture is to be tested according to [KM 64-438](#), *Asphalt Binder Content Determination of Asphalt Mixtures Based on the Maximum Specific Gravity*, obtain the field sample according to [Subsections 4.1 and 4.2](#) of this method.

Obtain the test portion as described in [Subsection 5.3](#) of this method. Ensure the test portion quantities comply with the amounts required in AASHTO T 209.

APPROVED 

DIRECTOR
DIVISION OF MATERIALS

DATE 12/28/04

Kentucky Method 64-425-05
Revised 12/28/04
Supersedes KM 64-425-02
Dated 12/13/01

REQUIREMENTS FOR PROCESS-CONTROL TESTING
AND INSPECTION OF ASPHALT MIXTURES BY THE CONTRACTOR

1. SCOPE -
 - 1.1. This method addresses the Contractor's process-control responsibilities for asphalt mixtures.
 - 1.2. Perform all testing for process-control and informational purposes according to the applicable Kentucky Method (KM) or AASHTO standard.
 - 1.3. According to Subsection 402.02 of the Department's *Standard Specifications for Road and Bridge Construction*, provide a Superpave Plant Technologist (SPT) to perform the initial plant setup for each mixture, set the job-mix formula (JMF) at the mixing plant, and conduct all tests to verify that the plant is producing a mixture within the specified tolerances.
 - 1.4. According to Subsection 402.02 of the Department's *Standard Specifications*, provide a Superpave Mix Design Technologist (SMDT) to adjust mix designs as needed. The SPT may perform these changes under the direction of the SMDT. If deemed appropriate by the Department, repeat any inspection, process-control testing, sampling or sample preparation, etc., necessary to ensure that the mixture supplied meets the applicable requirements.
2. EQUIPMENT AND PROCEDURES - The equipment and procedures necessary to fulfill the requirements of this method are described in the following KM's and AASHTO standards:
 - KM 64-401 *Calibrating and Checking Cold-Feed Flow on Asphalt Mixing Plants*
 - KM 64-404 *Sampling Liquid Asphalt Materials*
 - KM 64-405 *Extraction of Binder From Asphalt Paving Mixtures*
 - KM 64-407 *Sieve Analysis of Aggregate From Asphalt Mixing Plants*
 - KM 64-411 *Preparing Ingredient Materials for, and Performing, a Laboratory Mix Design of an Asphalt Mixture*
 - KM 64-421 *Establishing the Job-Mix Formula of Asphalt Mixtures by the Contractor*
 - KM 64-425 *Sampling Asphalt Mixtures*
 - KM 64-433 *Wet-Sieve Analysis of Aggregates Used in Asphalt Mixtures*
 - KM 64-434 *Determination of Moisture Content in Asphalt Mixtures (Rapid Field Test)*
 - KM 64-435 *Method for Acceptance of Asphalt Mixtures by Mixture Property Analysis*

KM 64-436	<i>Asphalt Binder Content Determination of Asphalt Mixtures by Plant Recordation</i>
KM 64-437	<i>Determination of Asphalt Binder Content of Asphalt Mixtures Using the Nuclear Asphalt Content Gauge</i>
KM 64-438	<i>Asphalt Binder Content Determination of Asphalt Mixtures Based on the Maximum Specific Gravity</i>
KM 64-439	<i>Sampling Asphalt Mixtures From the Paving Site</i>
KM 64-442	<i>Method for Coring and Determining Percent of Solid Density of In-Place, Compacted, Asphalt Mixture Courses</i>
KM 64-620	<i>Wet Sieve Analysis of Fine and Coarse Aggregate</i>
AASHTO R 35	<i>Superpave Volumetric Design for Hot Mix Asphalt (HMA)</i>
AASHTO T 2	<i>Sampling of Aggregates</i>
AASHTO T 27	<i>Sieve Analysis of Fine and Coarse Aggregates</i>
AASHTO T 166	<i>Bulk Specific Gravity (G_{mb}) of Compacted Hot Mix Asphalt (HMA) Using Saturated Surface-Dry Specimens</i>
AASHTO T 209	<i>Theoretical Maximum Specific Gravity (G_{mm}) and Density of Hot Mix Asphalt (HMA)</i>
AASHTO T 308	<i>Determining the Asphalt Binder Content of Hot Mix Asphalt (HMA) by the Ignition Method</i>
AASHTO T 312	<i>Preparing and Determining the Density of Hot Mix Asphalt (HMA) Specimens by Means of the Superpave Gyrotory Compactor</i>

3. PROCESS-CONTROL TESTING -

- 3.1. At the beginning of the construction season, submit a Quality Control Plan (QCP) to the appropriate District Materials Section Supervisor (DME) for approval for each plant using the TC 64-418 form, *Contractor's Quality Control Plan/Checklist*. The TC 64-418 form is available on the Division of Materials website (transportation.ky.gov/materials/asphaltmixtures.htm). This document details sampling, process-control testing, inspection, and the anticipated frequencies for each activity.

- 3.2. If changes in an approved QCP become necessary or desirable, submit a revised plan for approval.
- 3.3. Furnish all necessary resources (equipment, personnel, etc.) to comply with the Department's *Standard Specifications*, other contract requirements, and approved QCP.
- 3.4. See Addendum 1 for a list of the SPT's duties that are to be performed routinely.
- 3.5. For all projects, perform the following tests and checks at the minimum frequencies listed below:

3.5.1. <u>All Superpave mixtures</u>	<u>Minimum frequencies</u>
Cold-feed checks (when polish-resistant aggregate is required)	Two daily (a. m./p. m.)
Wet-sieve analysis	One during first subplot (setup period); one per lot thereafter

3.5.2. <u>Specialty mixtures</u>	<u>Minimum frequencies</u>
Open-Graded Friction Course (OGFC), Scratch Course, Sand Asphalt, Sand Seal Surface	
Cold-feed checks (when polish-resistant aggregate is required)	Two daily (a. m./p. m.)

3.5.3. <u>All Mixtures</u>	<u>Minimum frequencies</u>
Temperature checks of asphalt mixture	Hourly
Temperature checks of performance- graded (PG) binder	Four daily (two in a. m./two in p. m.)

3.5.4. Mixtures With Reclaimed Materials

Perform and document the results from one asphalt binder content and extracted gradation determination on the reclaimed materials for every two lots of mixture produced. Submit documented results to DME for review, upon completion of testing.

4. RECOMMENDED PRACTICES -

- 4.1. Develop a process-control testing program in keeping with the specific considerations at each plant site.

4.2. In addition to the acceptance tests required in Subsection 402.03.02 of the Department's *Standard Specifications*, the Department recommends, but does not require, the following minimum process-control tests and frequencies:

4.2.1. Perform one gradation determination, corresponding to the volumetric analysis for acceptance, per subplot.

4.2.2. During the setup period of Compaction Option A projects, determine the correlation between core density and the density meter reading. Perform one density determination for every 1200 yd² of surface area of mainline pavement thereafter using a density meter.

5. INSPECTION AND DOCUMENTATION -

5.1. In addition to process-control testing, perform the required plant and site inspection during production.

5.2. Document, and maintain a file of, all process-control tests and inspections. Document daily general observations, adjustments made to the mixture, and the results of all other inspections completed.

5.3. Keep, and update daily, control charts for all process-control, acceptance, and verification test results using the appropriate features of the *Asphalt Mixtures Acceptance Workbook* (AMAW).

ADDENDUM 1

DUTIES OF CONTRACTOR'S SPT

1. Check with the DME to ensure the plant has been calibrated (if required), inspected, and approved.
2. Check the laboratory for the necessary equipment and proper accreditation records as required by the applicable specifications.
3. Check the contract documents for the correct grade of PG binder and specifications pertaining to the asphalt mixtures involved.
4. Provide an approved copy of the JMF on an "Asphalt-Mixture-Design Results" form, or "MixPack" spreadsheet (including the random sampling tonnages for acceptance testing), from the Department at the asphalt plant field laboratory.
5. Provide an approved QCP (TC 64-418) on file at the field laboratory.
6. During production perform visual inspection of all stockpiles to ensure no contamination from other aggregates, dirt, and debris exists (for the duration of production run).
7. Check the bill-of-lading that accompanies each transport of PG binder for the type of material, approval number ("lot number"), county, project number, and signature of the certifying agency and supplier.

8. Maintain a file of all bills-of-lading for PG binder and tack material for a minimum of one year.
9. Check the use and rate of silicone, anti-stripping additive, fibers, or other specialty products when utilized in the asphalt mixture.
10. When requested and witnessed by Department personnel, obtain acceptance samples of the PG binder.
11. Furnish two “hand-mixed” maximum specific gravity samples upon completion of the setup period according to KM 64-438.
12. Perform visual inspection of the plant settings to ensure conformance with the JMF.
13. Check all truck beds to ensure all trucks have tarps and contain no contaminating material or unapproved release agent prior to loading them with asphalt mixture.
14. Inspect the loading of trucks to ensure that the asphalt mixture is being loaded in multiple drops using the “front-back-middle of the bed” sequence in order to minimize segregation. Do not allow trucks to be loaded by “dribbling” the asphalt mixture into the bed or by “topping off” the bed.
15. Fill out the AMAW completely (example copy attached), and submit the spreadsheet to the Department within five working days of the completion of each lot.
16. Complete all control charts documenting process-control, acceptance, and verification testing results daily using the appropriate features of the AMAW.
17. Record the time, truck or ticket numbers, and temperature of the asphalt mixture from which the test samples are taken on the AMAW.
18. Maintain familiarity with the KM’s and AASHTO standards that pertain to asphalt quality control and asphalt mixture testing.
19. Maintain familiarity with all applicable specifications that pertain to acceptance, process-control, or quality-control testing responsibilities.
20. Provide current copies of the applicable KM’s; AASHTO *Standard Specifications for Transportation Materials and Methods of Sampling and Testing* (Part 1, Specifications, and Part 2, Tests); and the Department’s *Standard Specifications* at the plant site at all times.

APPROVED

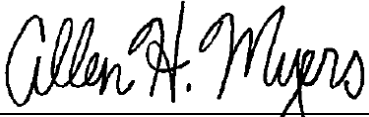

DIRECTOR
DIVISION OF MATERIALS

DATE

04/28/15

Kentucky Method 64-426-15

Revised 04/28/15

Supersedes KM 64-426-02

Dated 08/16/12

Attachments

CONTROL AND ACCEPTANCE OF ASPHALT MIXTURES

PAY VALUE (%) PER LOT

Sample ID: 10414ABC080012
 Contract I.D.: 091111
 Type Mix: Successor 0.38
 Item Code: 0336
 Lot #: 2
 TONS in Lot: 4000.00
 Unit Price (\$): 50.00
 County: Blanton
 ESAL Class: 3
 KYTC Lab ID: T415
 Preferred Supplier Code: Hot'n Black Paving @ Kennedyville
 Approved Mix Design: 00640AMD079999
 Acceptance Method: Volumetrics
 P/S Lab ID: C333
 Approval Authorized By: Willie Carrier
 Name: Willie Carrier
 ID: wcarrier

Binder Content			Air Voids			VMA				
JMF % AC	Sublot % AC	Deviation from JMF	Pay Value (%)	Target (%)	Sublot % AV	Pay Value (%)	Min. % VMA	Sublot % VMA	Deviation from Min.	Pay Value (%)
5.7	5.6	-0.1	100.0	4.0	2.5	95.00	15.0	14.0	-1.0	90.0
5.7	6.0	0.3	100.0	4.0	2.9	99.00	15.0	14.6	-0.4	95.0
5.7	5.7	0.0	100.0	4.0	3.3	103.00	15.0	14.6	-0.4	95.0
5.7	5.5	-0.2	100.0	4.0	4.0	105.00	15.0	14.7	-0.3	95.0
Lot Average			100.00	Lot Average	4.0	100.50	Lot Average			93.75

Density	
Sublot Avg.	Pay Value (%)
Joint Density	100.0
Lane Density	100.31

% Pay	
Property	15
Joint Density	30
Lane Density	5
% AC	25
% AV	25
% VMA	25

Final Pay Values And Adjustments	
Pavement Wedge Tons**	
Final Pay Value Mainline (%)	98.66
For Lot #	2
Lot Tonnage Adjustment	-53.750
Lot Pay Adjustment (\$)	-2687.500

** Only necessary when placed Monolithically with Mainline

Aggregate Information			
Aggr. Prod. Name	Aggr. Code #	Matl. Type & Size	Matl. Code #
Hard & Brittle Stone Company	AGP062901	Dolomite #8's Class A	10400
Green Valley Rock	AGP073501	LS #8's Class A	10400
Green Valley Rock	AGP073501	LSS (Washed)	10310
Muddy River Sand, Inc.	AGP057202	Natural Sand	10436

Pay Values for Acceptance by Gradation and Asphalt Binder Content			
Sublot	Target JMF or FM	Test Result	Pay Value
1			
2			
3			
4			
Lot Average			
Sublot # 1	Sublot # 2	Sublot # 3	Sublot # 4
QWK3520522	QWK3520522	QWK3520522	QWK3520522
ROK3463600	ROK3463600	ROK3463600	ROK3463600
Manufacturer	% & Type Additive (if used)		
LAP100201	0.5% Stick-2-it Plus		

Verification Results			
Test	Results	1 vs. 1	1 vs. 3
% AC	5.6	0.1	0.1
% AV	1.5	-1.0	+1.9
% VMA	13.5	-0.4	1.1
Verification Results			
Test	Results	1 vs. 1	1 vs. 3
% AC	5.7	0.2	0.1
% AV	4.2	0.2	-1.3
% VMA	15.1	0.4	-0.7
Sublot Verified By			
Name	Willie Carrier	ID #	wcarrier

Sample ID: 10414BC080012	County: Blanton
Contract I.D. 091111	
Type Mixture: Superpave 0.38	
Sublot # 1 Tested by: claid	Sublot # 2 Tested by: claid
Sublot # 3 Tested by: claid	Sublot # 4 Tested by: claid
Sublot # 5 Tested by: claid	Sublot # 6 Tested by: claid

Sublot #	Sample #	% AC (Mx)		Weight (g)		Bulk Vol.		Unit Wt.	Max Spec Gravity	% Voids	% Abs. AC (Mx)	Eff. AC	% VMA	% VFA	D/A Ratio
		(Ar)	(SSD)	(Water)	(SSD)	(Ar)	(SSD)								
1	1	4812.1	2523.0	4815.4	1922.4	2.415									
2	2	4808.4	2821.6	4811.7	1960.1	2.416									
Average		5.6				2.416	150.7	2.477	2.5	1.04	4.5	14.0	82.4	1.4	

Sublot #	Sample #	% AC (Mx)		Weight (g)		Bulk Vol.		Unit Wt.	Max Spec Gravity	% Voids	% Abs. AC (Mx)	Eff. AC	% VMA	% VFA	D/A Ratio
		(Ar)	(SSD)	(Water)	(SSD)	(Ar)	(SSD)								
1	1	4811.3	2817.3	4813.2	1965.9	2.411									
2	2	4805.5	2811.4	4808.4	1997.0	2.406									
Average		6.0				2.408	150.3	2.481	2.9	1.04	5.0	14.6	80.1	1.3	

Sublot #	Sample #	% AC (Mx)		Weight (g)		Bulk Vol.		Unit Wt.	Max Spec Gravity	% Voids	% Abs. AC (Mx)	Eff. AC	% VMA	% VFA	D/A Ratio
		(Ar)	(SSD)	(Water)	(SSD)	(Ar)	(SSD)								
1	1	4804.3	2808.8	4811.0	2007.2	2.401									
2	2	4800.7	2806.1	4808.3	2002.2	2.398									
Average		5.7				2.400	149.7	2.483	3.3	1.06	4.7	14.6	77.1	0.8	

Sublot #	Sample #	% AC (Mx)		Weight (g)		Bulk Vol.		Unit Wt.	Max Spec Gravity	% Voids	% Abs. AC (Mx)	Eff. AC	% VMA	% VFA	D/A Ratio
		(Ar)	(SSD)	(Water)	(SSD)	(Ar)	(SSD)								
1	1	4807.6	2804.9	4812.2	2007.3	2.396									
2	2	4799.9	2804.3	4811.6	2007.3	2.391									
Average		5.5				2.393	149.3	2.463	4.0	1.05	4.5	14.7	72.8	0.7	

Sublot #	Sample #	% AC (Mx)		Weight (g)		Bulk Vol.		Unit Wt.	Max Spec Gravity	% Voids	% Abs. AC (Mx)	Eff. AC	% VMA	% VFA	D/A Ratio
		(Ar)	(SSD)	(Water)	(SSD)	(Ar)	(SSD)								
1	1	4810.5	2810.5	4812.5	2007.5	2.395									
2	2	4805.0	2805.0	4810.0	2002.5	2.390									
Average		5.5				2.393	149.3	2.463	4.0	1.05	4.5	14.7	72.8	0.7	

Sublot #	Sample #	% AC (Mx)		Weight (g)		Bulk Vol.		Unit Wt.	Max Spec Gravity	% Voids	% Abs. AC (Mx)	Eff. AC	% VMA	% VFA	D/A Ratio
		(Ar)	(SSD)	(Water)	(SSD)	(Ar)	(SSD)								
1	1	4810.5	2810.5	4812.5	2007.5	2.395									
2	2	4805.0	2805.0	4810.0	2002.5	2.390									
Average		5.5				2.393	149.3	2.463	4.0	1.05	4.5	14.7	72.8	0.7	

Sublot #	Sample #	% AC (Mx)		Weight (g)		Bulk Vol.		Unit Wt.	Max Spec Gravity	% Voids	% Abs. AC (Mx)	Eff. AC	% VMA	% VFA	D/A Ratio
		(Ar)	(SSD)	(Water)	(SSD)	(Ar)	(SSD)								
1	1	4810.5	2810.5	4812.5	2007.5	2.395									
2	2	4805.0	2805.0	4810.0	2002.5	2.390									
Average		5.5				2.393	149.3	2.463	4.0	1.05	4.5	14.7	72.8	0.7	

Sublot #	Sample #	% AC (Mx)		Weight (g)		Bulk Vol.		Unit Wt.	Max Spec Gravity	% Voids	% Abs. AC (Mx)	Eff. AC	% VMA	% VFA	D/A Ratio
		(Ar)	(SSD)	(Water)	(SSD)	(Ar)	(SSD)								
1	1	4810.5	2810.5	4812.5	2007.5	2.395									
2	2	4805.0	2805.0	4810.0	2002.5	2.390									
Average		5.5				2.393	149.3	2.463	4.0	1.05	4.5	14.7	72.8	0.7	

RANDOM TONS FOR EACH SUBLLOT										AGGREGATE			
Sublot	Date	Time	Truck #	Tons	Temp	Agg. Prod. Code	Mat. Type & Size	Sp. Grav.	%	Sublot # 1	Sublot # 2	Sublot # 3	Sublot # 4
1	05/22/09	8:20 AM	555	369.00	335	AGP002801	Dolomite #6's Class A	2.67	19.0	22.0	21.0	21.0	22.0
2	05/22/09	2:25 PM	222	1456.00	328	AGP073501	LS #6's Class A	2.68	21.0	18.0	20.0	18.0	18.0
3	05/23/09	9:30 AM	398	2766.00	330	AGP073501	LSS (Washed)	2.65	42.0	42.0	37.0	40.0	40.0
4	05/24/09	10:00 AM	400	3540.00	330	AGP057202	Natural Sand	2.60	18.0	18.0	22.0	20.0	20.0

Sublot G _{max}	2.65
Sublot G ₂₀	2.65

Cage				2.728
------	--	--	--	-------

POLISH RESISTANT DATA			
Date	% Coarse	% Fine	%
05/22/09	39	18	
05/23/09	43	20	
05/23/09	42	20	

Gyrations	75
-----------	----

Maximum Specific Gravity			
Sublot #	Sample #	Sublot #	Sample #
1	1	2	2
2	2	3	3
Average		Average	

Hand-Mixed			
Sublot #	Sample #	Sublot #	Sample #
1	1	2	2
2	2	3	3
Average		Average	

Moisture Content of Mixture			
Sublot #	Sample #	Sublot #	Sample #
1	1	2	2
2	2	3	3
Average		Average	

Moisture Content of Mixture			
Sublot #	Sample #	Sublot #	Sample #
1	1	2	2
2	2	3	3
Average		Average	

Sample ID#: 10414ABC080012
 Contract ID: 091111
 Type Mixture: Superpave 0.38

Inspectors ID #: wcarrier
 Inspectors Name: Willie Carrier
 Producer & Location: Hot 'n Black Paving @ Kennedyville

CORE DENSITIES									
Core Number	Station #/ Offset/ Coarse #	MSG of Sublot	Core Wt. In Air (g)	Core Wt. In Water (g)	Core Wt. SSD (g)	Bulk Sp. Gravity	Core Density (kg/m ³)	% Solid Density (%)	Pay Value (%)
2-1-A	1+23 6'R	2.477	708.1	415.8	727.0	2.275	142.0	91.9	95
2-1-B	3+47 4'R		711.6	418.3	725.9	2.313	144.4	93.4	100
2-1-C	4+12 3'L		720.1	422.1	730.3	2.336	145.8	94.3	105
2-1-D	6+78 7'L		701.2	419.0	719.8	2.331	145.5	94.1	105
Sublot Average									101.3
2-2-A	6+83 1'R	2.481	725.8	410.0	729.9	2.269	141.6	91.5	95
2-2-B	8+20 6'L		732.1	421.3	740.2	2.296	143.3	92.6	100
2-2-C	9+31 1'L		703.6	418.5	714.7	2.375	148.2	95.8	105
2-2-D	10+11 8'L		714.5	426.1	733.6	2.324	145.0	93.7	100
Sublot Average									100.0
2-3-A	11+39 2'R	2.483	692.4	408.2	710.7	2.289	142.8	92.2	100
2-3-B	13+00 3'L		713.5	414.5	722.6	2.316	144.5	93.3	100
2-3-C	13+95 3'R		729.4	420.9	739.2	2.292	143.0	92.3	100
2-3-D	15+02 7'R		710.1	409.3	715.8	2.317	144.6	93.3	100
Sublot Average									100.0
2-4-A	16+77 1'L	2.493	713.6	411.2	720.6	2.306	143.9	92.5	100
2-4-B	17+23 10'L		680.5	399.6	693.6	2.315	144.4	92.8	100
2-4-C	18+08 3'L		720.0	413.8	730.0	2.277	142.1	91.3	95
2-4-D	18+75 5'L		693.5	411.7	705.7	2.359	147.2	94.6	105
Sublot Average									100.0
Lot Average									100.31

Joint Cores									
2-1-J1	2+22	2.477	728.6	418.3	742.2	2.249	140.4	90.8	100
2-1-J2	5+68		677.5	389.6	694.8	2.220	138.5	89.6	100
Sublot Average									100.0
2-2-J1	7+12	2.481	728.6	418.3	742.2	2.249	140.4	90.7	100
2-2-J2	9+42		677.5	389.6	694.8	2.220	138.5	89.5	100
Sublot Average									100.0
2-3-J1	12+07	2.483	728.6	418.3	742.2	2.249	140.4	90.6	100
2-3-J2	13+81		677.5	389.6	694.8	2.220	138.5	89.4	100
Sublot Average									100.0
2-4-J1	17+87	2.493	728.6	418.3	742.2	2.249	140.4	90.2	100
2-4-J2	18+13		677.5	389.6	694.8	2.220	138.5	89.0	100
Sublot Average									100.0
Lot Average									100.00

Date Tested			
Sublot # 1	5/23/09	Sublot # 3	5/24/09
Sublot # 2	5/23/09	Sublot # 4	5/25/09

Sample ID: 10414ABC080012
 Contract I.D. 091111
 Type Mixture: Superpave 0.38

Producer & Location: Hot 'n Black Paving @ Kennedyville

Gyrations	
@ N ₉₅	75

Sample #	% AC (Mix)	Weight (g)		Bulk Vol.	BSG	Unit Wt.	Max Spec Gravity	% Voids	% Eff. AC	% VMA	% VFA	D/A Ratio
		(Air)	(Water)									
1		4812.1	2834.7	1980.7	2.429							
2		4808.4	2830.1	1979.9	2.429							
Average	5.6			151.6	2.429	151.6	2.465	1.5	4.6	13.5	89.1	1.4

Inspectors Name: Willie Carrier

Wcarrier

Sample #	% AC (Mix)	Weight (g)		Bulk Vol.	BSG	Unit Wt.	Max Spec Gravity	% Voids	% Eff. AC	% VMA	% VFA	D/A Ratio
		(Air)	(Water)									
1		4820.7	2820.6	2018.6	2.388							
2		4811.3	2811.7	2019.4	2.383							
Average	5.7			148.8	2.385	148.8	2.490	4.2	4.6	15.1	72.0	0.7

Inspectors Name: Willie Carrier

Wcarrier

	Sublot #1a	Sublot #1b	Sublot #4a	Sublot #4b
Wt. of Mix	1555.9	1528.8	1521.3	1550.6
Calibration	1401.2	1401.2	1401.2	1401.2
Wt. of Mix + Calibrat.	2957.1	2930.0	2922.5	2951.8
Final Wt.	2326.4	2309.5	2311.4	2329.4
Absorbed Water				
MSG	2.467	2.464	2.489	2.491
Avg. =		2.465	Avg. =	2.490

Binder Content Verif. Sublot # 1	Binder Content Verif. Sublot # 4
Printed Ticket	Printed Ticket
As Tested % AC: 5.7	As Tested % AC: 5.7
Act. % AC for Verif.: 5.6	Act. % AC for Verif.: 5.7
% AC by Back-Calc. = 6.5	% AC by Back-Calc. = 5.8

Sieve Size	Verif. for Sublot #1		Verif. for Sublot #4	
	Grams Retained	Percent Passing	Grams Retained	Percent Passing
2"				
1 1/2"				
1"				
3/4"				
1/2"	0.0	100.0	0.0	100.0
3/8"	136.0	96.2	112.7	96.6
1/4"				
# 4	455.8	87.4	408.3	87.8
# 8	2109.7	58.3	1986.4	40.5
# 16	2563.2	70.8	2373.3	29.0
# 30	2874.8	79.4	2599.9	22.2
# 50	3018.6	83.3	2837.7	15.1
# 100				
# 200	3432.5	94.8	3131.4	6.3
PAN				
Total	3621.8		3341.0	

Moisture Content of Mixture	
Weight of Pan and Mixture before Drying	Sublot #1 3443.0
Weight of Pan and Mixture after Drying	Sublot #1 3441.6
Weight of Pan	Sublot #1 1100.7
% Moisture in Mix	Sublot #1 0.1
	Sublot #4 3218.3
	Sublot #4 3217.9
	Sublot #4 1100.7
	Sublot #4 0.0

Sample ID: 10414ABC080012
 Contract I.D. 091111
 Type of Mixture: Superpave 0.38

Inspectors ID #: claird
 Inspectors Name: Cary Laird
 Producer & Location: Hot 'n Black Paving @ Kennedyville

Sieve Size	SUBLOT # 1			SUBLOT # 2			SUBLOT # 3			SUBLOT # 4		
	Grams Retained	Percent Retained	Percent Passing	Grams Retained	Percent Retained	Percent Passing	Grams Retained	Percent Retained	Percent Passing	Grams Retained	Percent Retained	Percent Passing
2"												
1 1/2"												
1"												
3/4"												
1/2"	0.0	0.0	100.0	0.0	0.0	100.0	0.0	0.0	100.0	0.0	0.0	100.0
3/8"	267.4	7.5	92.5	298.7	7.8	92.2	220.0	6.3	93.7	248.3	7.1	92.9
1/4"												
# 4	504.9	14.2	85.8	571.5	15.0	85.0	427.5	12.3	87.7	499.7	14.2	85.8
# 8	2334.3	65.8	34.2	2245.9	58.8	41.2	2201.4	63.4	36.6	2127.3	60.6	39.4
# 16	2543.8	71.7	28.3	2621.0	68.6	31.4	2654.7	76.4	23.6	2751.6	78.4	21.6
# 30	2847.8	80.3	19.7	3006.6	78.7	21.3	2888.4	83.1	16.9	2943.9	83.9	16.1
# 50	2998.8	84.5	15.5	3196.3	83.7	16.3	2978.9	85.7	14.3	3012.2	85.8	14.2
# 100												
# 200	3321.6	93.6	6.4	3577.8	93.6	6.4	3338.9	96.1	3.9	3404.4	97.0	3.0
Pan												
Total	3547.2			3820.9			3474.3			3510.6		

Printed Ticket		Extraction		Ignition Furnace		NACG	
As Tested % AC:	5.7	As Tested % AC:	6.1	As Tested % AC:	5.8	As Tested % AC:	5.6
Act. % AC for Accept.:	5.6	Act. % AC for Accept.:	6.0	Act. % AC for Accept.:	5.7	Act. % AC for Accept.:	5.5
% AC by Back-Calc. =	6.2	% AC by Back-Calc. =	6.0	% AC by Back-Calc. =	6.0	% AC by Back-Calc. =	5.7

Superpave Mixtures (Gradation Analysis)

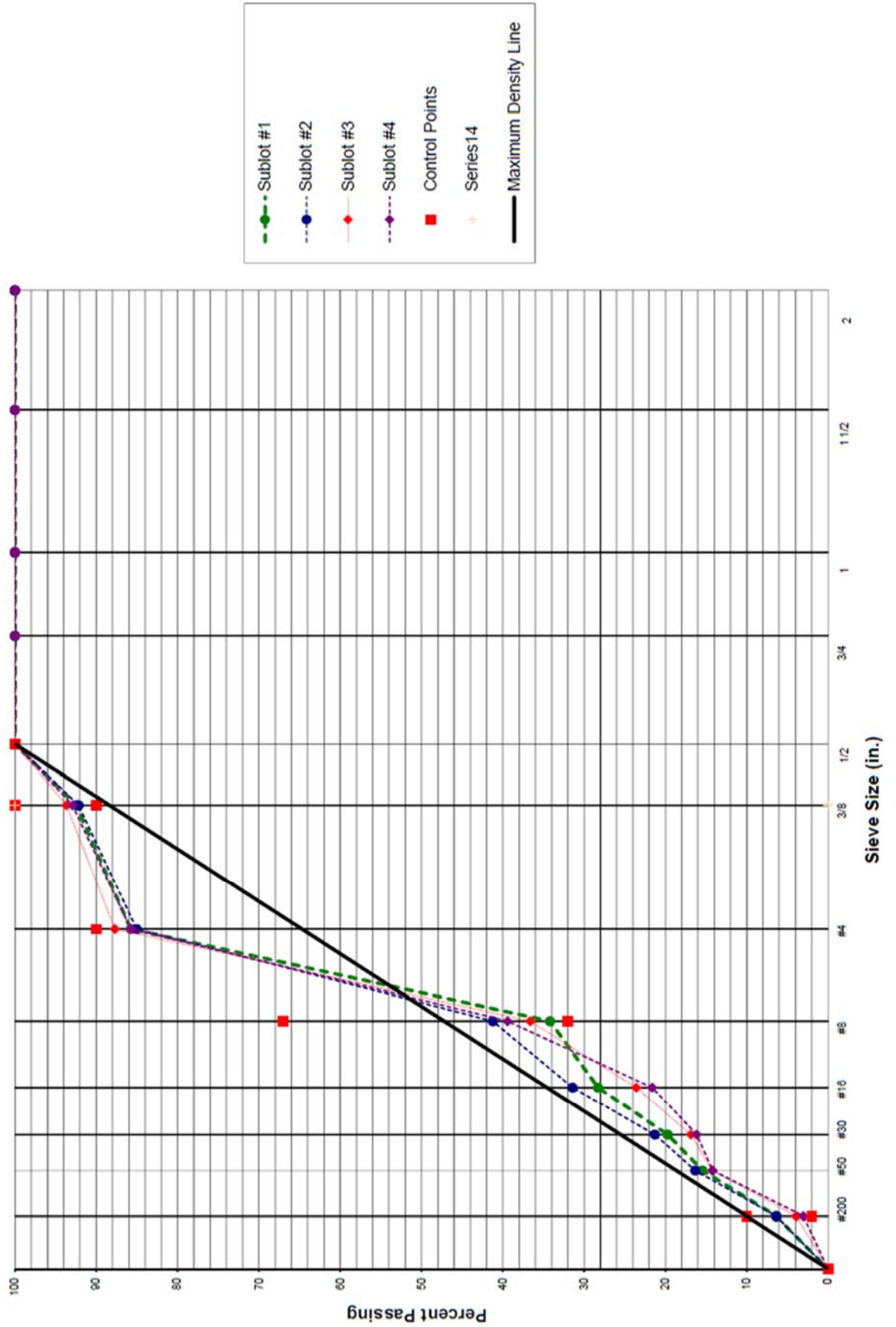

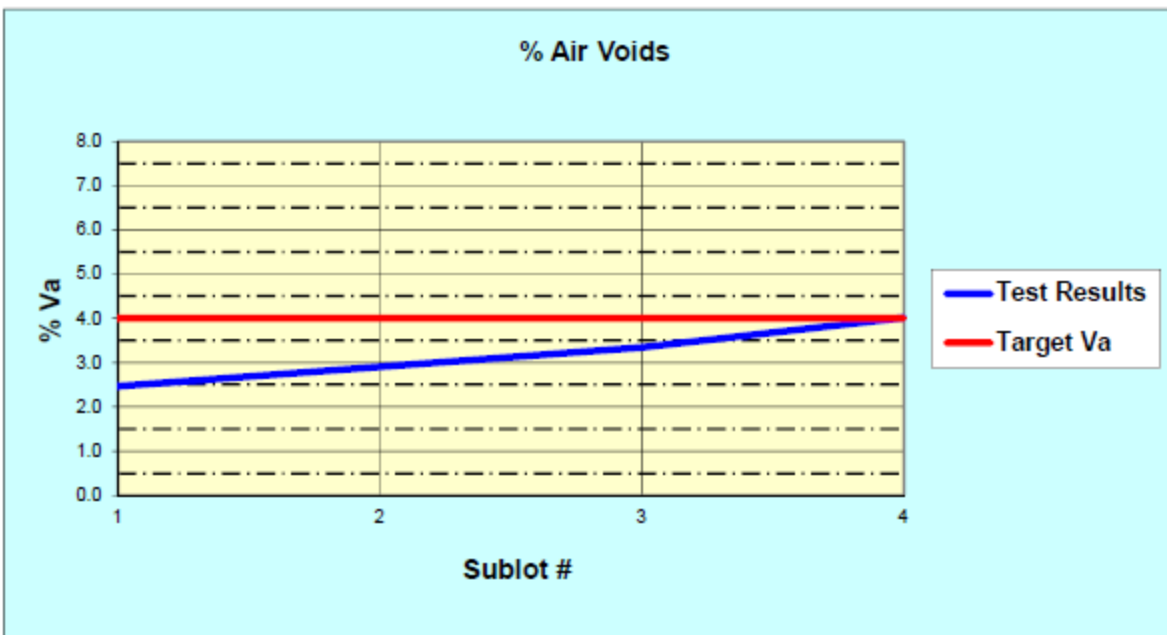
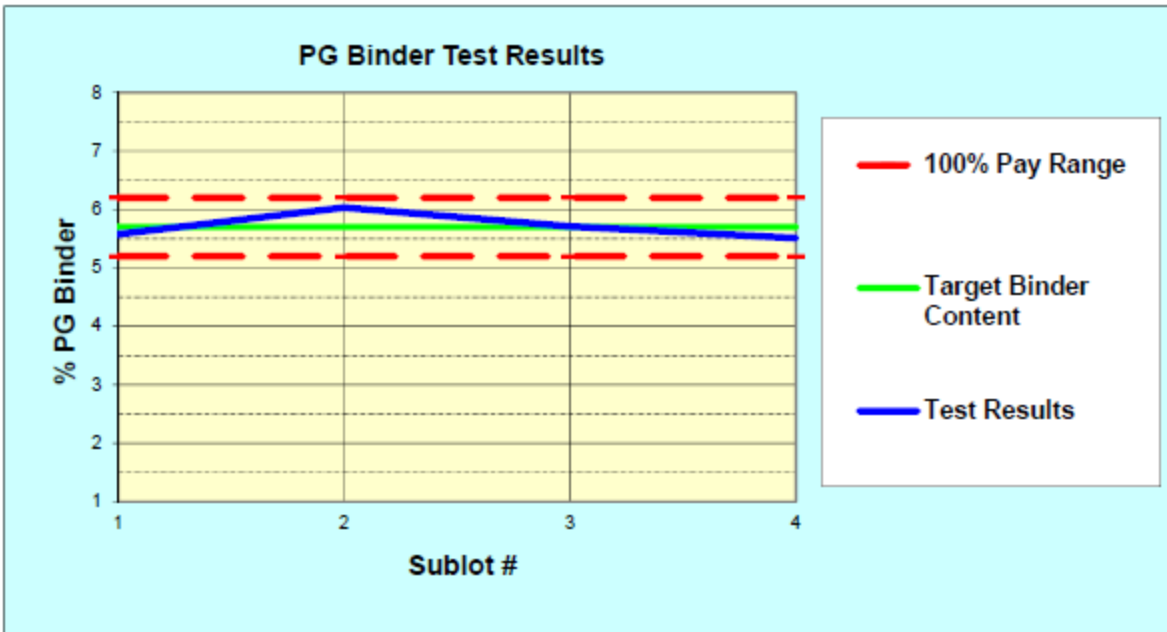

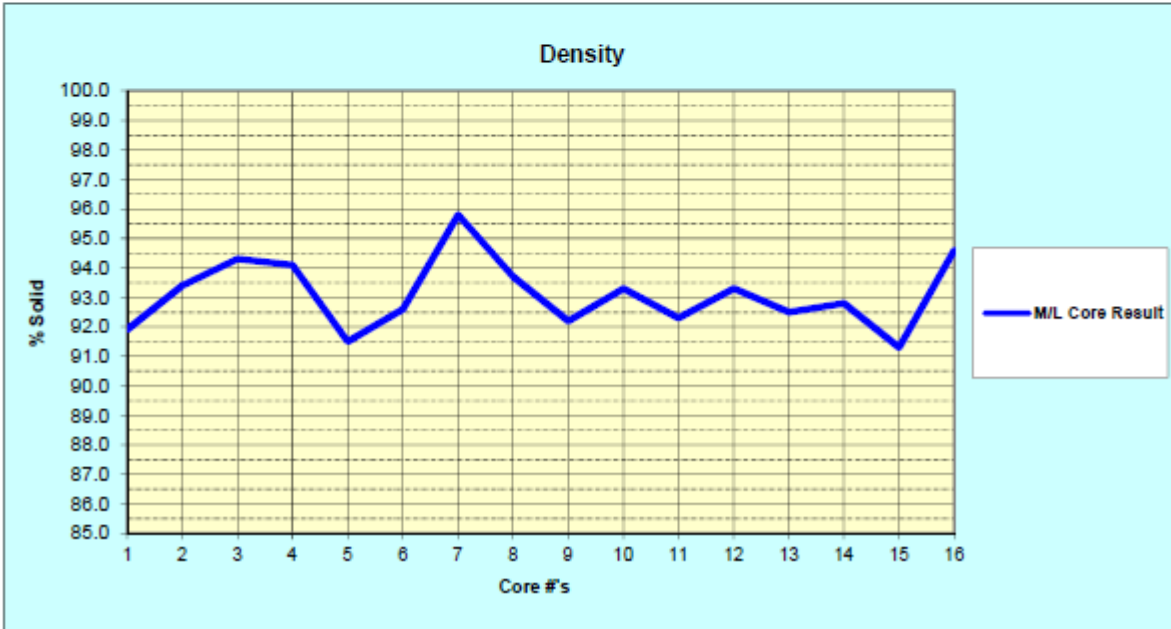
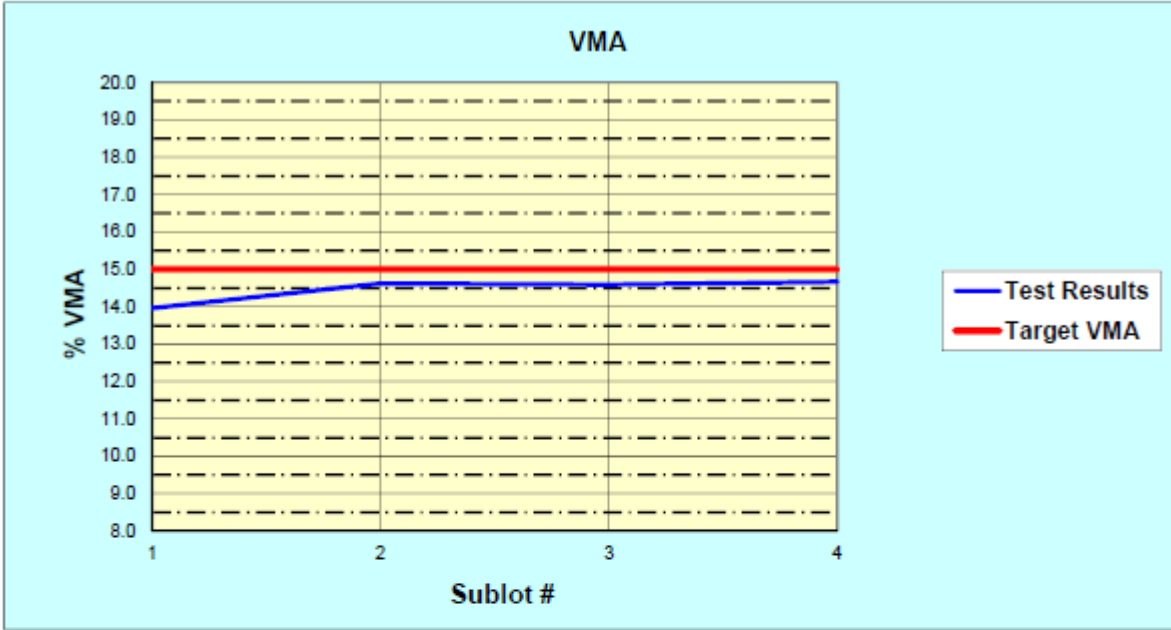

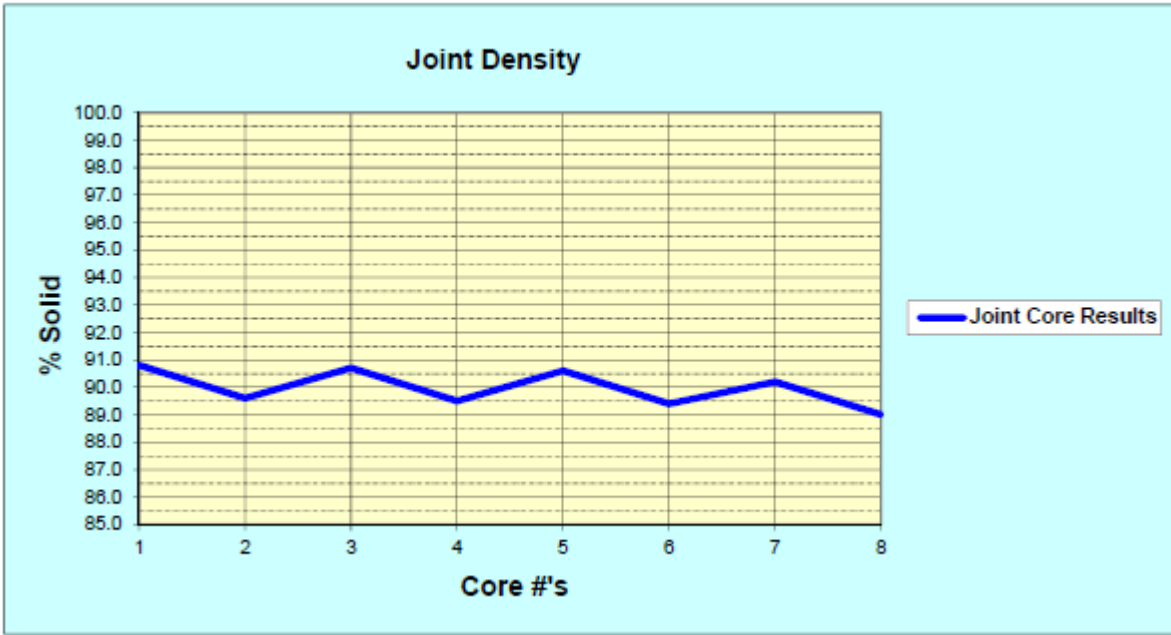

COMMENTS

Please include any comments concerning Volumetric Properties or Densities for the subject mixture.

Please include any comments concerning Volumetric Properties or Densities for the subject mixture.

Site Manager User I.D.	Technicians Name
claird	Cary Laird

Kentucky Method 64-427-05
Revised 12/28/04
Supersedes KM 64-427-04
Dated 03/04/04

METHOD FOR DESIGNING ASPHALT MIXTURES
CONTAINING RECYCLED-ASPHALT PAVEMENT (RAP)

1. SCOPE AND RELATED METHODS:

- 1.1. This method covers the procedure for designing asphalt mixtures that contain recycled-asphalt pavement (RAP). This procedure requires the utilization of several other methods during the design process, including:

[Kentucky Method \(KM\) 64-405](#), *Extraction of Binder From Asphalt Paving Mixtures*

[KM 64-411](#), *Preparing Ingredient Materials for, and Performing, a Laboratory Mix Design of an Asphalt Mixture*

[KM 64-421](#), *Establishing the Job-Mix Formula of Asphalt Mixtures by the Contractor*

[KM 64-433](#), *Wet-Sieve Analysis of Aggregates Used in Asphalt Mixtures*

[KM 64-620](#), *Wet Sieve Analysis of Fine and Coarse Aggregate*

AASHTO R 30, *Mixture Conditioning of Hot-Mix Asphalt (HMA)*

AASHTO R 35, *Superpave Volumetric Design for Hot-Mix Asphalt (HMA)*

AASHTO T 84, *Specific Gravity and Absorption of Fine Aggregate*

AASHTO T 85, *Specific Gravity and Absorption of Coarse Aggregate*

AASHTO T 209, *Theoretical Maximum Specific Gravity and Density of Bituminous Paving Mixtures*

AASHTO T 316, *Viscosity Determination of Asphalt Binder Using Rotational Viscometer*

ASTM D 5404, *Recovery of Asphalt from Solution Using the Rotary Evaporator*

2. APPARATUS:

- 2.1. Provide the equipment necessary for the extraction of the asphalt binder from the RAP conforming to [KM 64-405](#) (Method A) with the addition of:

2.1.1. A suitable container for catching the effluent from the centrifuge.

2.1.2. Reagent-grade trichloroethylene (to be used as the extraction solvent).

- 2.2. Provide the equipment necessary to determine the gradation of each individual virgin aggregate conforming to [KM 64-620](#). Provide the equipment necessary to determine the gradation of the extracted aggregate from the RAP conforming to [KM 64-433](#).
 - 2.3. Provide the equipment necessary for the recovery of asphalt binder from solution by the rotary evaporator method conforming to D 5404.
 - 2.4. Provide the equipment necessary to determine the viscosity of: (1) the asphalt binder recovered from the RAP; and (2) the blended asphalt binder (the virgin asphalt binder plus the asphalt binder recovered from the RAP) conforming to T 316.
 - 2.5. Provide the equipment necessary to perform an asphalt mixture design conforming to R 35.
3. PROCEDURE (RAP, Overall Gradation, and Blended Asphalt Binder Analyses):
- 3.1. The number of extractions, extracted gradations, and rotary evaporator recovery's required to be performed on the RAP depends on the percentage of RAP in the mixture (by weight of the total mixture). The breakdowns are shown below:

Percentage of RAP in the Mixture	Number of Extractions/Extracted Gradations to be Performed	Number of Rotary Evaporator Recovery's to be Performed
≤ 20	1	0
21 – 30	2	0
≥ 31	3	1

- 3.2. Oven-dry the RAP to a constant mass at a temperature of 221 ± 9 °F, and extract the asphalt binder from the RAP according to [KM 64-405](#) (Method A). Strictly observe those safety precautions mentioned in [KM 64-405](#) with respect to this operation.
 - 3.2.1. Calculate the percentage of asphalt binder in the RAP according to [KM 64-405](#) (Method A). Designate this value as P_{sb} for further calculations. If the percentage of RAP in the mixture requires multiple examinations, average the P_{sb} values from each analysis to obtain one overall P_{sb} for the RAP.
 - 3.2.2. If the percentage of RAP in the mixture requires rotary evaporator recovery testing, retain the effluent from the extraction for further testing.
- 3.3. Determine the gradation of the extracted RAP aggregate according to [KM 64-433](#). If the percentage of RAP in the mixture requires multiple examinations, average the gradation values from each analysis to obtain one overall gradation for the RAP.
- 3.4. If the percentage of RAP in the mixture requires rotary evaporator recovery testing, recover the asphalt binder (extracted from the RAP) from the effluent according to D 5404. Strictly observe those safety precautions mentioned in D 5404 with respect to this operation.
- 3.5. If the percentage of RAP in the mixture requires rotary evaporator recovery testing, determine

the viscosity of the recovered asphalt binder according to T 316.

- 3.6. Select the percentage of RAP (by weight of the total mixture) to be used in the mixture.
- 3.7. Determine the gradation of each individual virgin aggregate according to [KM 64-620](#).
- 3.8. Mathematically blend the virgin aggregates and the RAP aggregate together such that the combined job-mix formula (JMF) is both desirable and feasible. Ensure this JMF satisfies the gradation requirements for the type of mixture specified.

3.8.1. Use the following formula for blending aggregates:

$$P = Aa + Bb + Cc + \dots, \text{ where}$$

- P = the percentage of the combined aggregates passing a given sieve;
- A, B, C, ... = the percentage of material passing a given sieve for the individual aggregates; and
- a, b, c, ... = the proportions of individual aggregates used in the combination, where the total equals 1.00.

3.8.2. Since the process of blending aggregates is rather confusing and difficult to explain, especially when RAP is involved, follow the example below.

3.8.2.1. Assume that limestone # 78's, limestone sand, natural sand, and RAP aggregate are blended together to comply with the gradation requirements for a 0.5-in. nominal-maximum mixture. It has already been determined that 31 % RAP is to be used in the mixture. The washed gradations of the individual virgin aggregates and RAP are shown below:

	Limestone # 78's	Limestone Sand	Natural Sand	RAP
Sieve Size	Percent Passing	Percent Passing	Percent Passing	Percent Passing
3/4 in.	100	100	100	100
1/2 in.	95	100	100	90
3/8 in.	72	100	100	65
No. 8	3	70	80	26
No. 16	2	45	50	20
No. 30	2	27	25	15
No. 50	1	20	15	11
No. 200	1.0	12.0	1.0	7.0

3.8.2.2. Since the percentage of RAP aggregate and the individual gradations of all component aggregates (virgin and RAP) are known, the only unknowns are the percentages of the three virgin aggregates. Determining these percentages is largely a matter of “trial-and-error”. If the percentages used for the first trial do not satisfy the gradation requirements for the mixture, adjust the percentages until an acceptable result is obtained. Further explanation of the aggregate-blending process is offered in [KM 64-421](#).

For this example, the percentages to be used will be 32 % limestone # 78's, 17 % limestone sand, 20 % natural sand, and 31 % RAP. Using the formula displayed in [Subsection 3.8.1](#) and all known values, determine the combined gradation, for the 3/8-in. sieve, as follows:

$$P = 72 (0.32) + 100 (0.17) + 100 (0.20) + 65 (0.31) = 80 \%$$

The following table shows the combined gradation for each sieve for this particular mixture:

	LS # 78's	LS Sand	Natural Sand	RAP		
% in Mix	32	17	20	31		
Sieve Size	Percent Passing	Percent Passing	Percent Passing	Percent Passing	Combined Gradation	Control Points
3/4 in.	100	100	100	100	100	100 min.
1/2 in.	95	100	100	90	95	90 - 100
3/8 in.	72	100	100	65	80	90 max.
No. 8	3	70	80	26	37	28 - 58
No. 16	2	45	50	20	24	
No. 30	2	27	25	15	15	
No. 50	1	20	15	11	10	
No. 200	1.0	12.0	1.0	7.0	4.5	2.0 - 10.0

This blend is certainly not the only one that will satisfy the gradation requirements for a 0.5-in. nominal-maximum mixture, but for the sake of this illustration, this blend will be used in further examples.

- 3.9. Estimate the total percentage of asphalt binder to be used in the RAP mixture by using the following empirical formula:

$$P_b = 0.035a + 0.045b + Kc + F, \text{ where}$$

- P_b = the approximate, total asphalt binder demand of the mixture;
 a = the percent of aggregate retained on the No. 8 sieve;
 b = the percent of aggregate passing the No. 8 sieve and retained on the No. 200 sieve;
 c = the percent of aggregate passing the No. 200 sieve;
 K = 0.15 for 11 - 15 percent passing the No. 200 sieve, 0.18 for 6 - 10 percent passing the No. 200 sieve, and 0.20 for 5 percent or less passing the No. 200 sieve; and
 F = 0 - 2.0 percent (based on absorption of light or heavy aggregate).
 In the absence of other data, use a value of 0.7 for F .

For example, using the combined gradation as shown in Subsection 3.8.2.2, determine the approximate total asphalt binder demand of the mixture by the following:

$$P_b = 0.035 (63.0) + 0.045 (32.5) + 0.20 (4.5) + 0.7 = 5.3 \%$$

- 3.10. To select the appropriate grade of virgin asphalt binder to blend with the RAP in order to obtain a blended asphalt binder that satisfies the requirements of the grade for the specified mixture, follow the directions given in Subsection 409.03 of the Department's *Standard Specifications*. When using 31 percent or more RAP in the mixture, select the binder grade for the virgin asphalt binder using the following procedure:

- 3.10.1. From the mixture's bid item, determine the grade of asphalt binder specified. Then, determine the range of acceptable viscosities for that grade from the table below. This information is necessary to ensure the viscosity of the blended asphalt binder (the recovered asphalt binder plus the virgin asphalt binder) satisfies the requirements of the grade specified for the mixture in question.

PG Binder Type	Range of Viscosity from T 316 (Pa·s)
PG 58-22	0.26-0.35
PG 64-22	0.36-0.58
PG 70-22	0.59-0.90
PG 76-22	0.91-3.35

- 3.10.2. Determine the viscosity of the recovered asphalt binder from the RAP according to T 316.

- 3.10.2.1. Determine the viscosity of the virgin asphalt binder to be blended with the recovered asphalt binder from the RAP to result in a combined asphalt binder that will satisfy the specifications as determined in Subsection 3.10.1 by following the directions given below:

3.10.2.1.1. Estimate the percent of virgin asphalt binder to be added to the total mixture by using the following formula:

$$P_{nb} = \frac{(100^2 - rP_{sb})P_b}{100(100 - P_{sb})} - \frac{(100 - r)P_{sb}}{100 - P_{sb}}, \text{ where}$$

P_{nb} = the percent of virgin asphalt binder in the mixture;
 r = the virgin aggregate expressed as a percent of the total aggregate in the mixture;
 P_b = the estimated, total asphalt binder demand of the mixture in percent (Subsection 3.9); and
 P_{sb} = the asphalt binder content (AC) of the RAP in percent (Subsection 3.2). For example, suppose the AC of the RAP, P_{sb} , in a 0.5-in. nominal-maximum mixture is 5.6 % and the mixture contains 31 % RAP, then:

$$P_{nb} = \frac{[100^2 - 69(5.6)]5.3}{100(100 - 5.6)} - \frac{(100 - 69)5.6}{100 - 5.6} = 3.5\%.$$

3.10.2.1.2. Calculate the ratio of virgin asphalt binder, P_{nb} (as a percentage), to the total AC of the mixture, P_b , by using the following formula:

$$R_1 = \frac{100P_{nb}}{P_b}.$$

For example, given the mixture described in Subsection 3.10.2.1.1, the ratio, R_1 , of the virgin asphalt binder to the total asphalt binder is:

$$R_1 = \frac{100(3.5)}{5.3} = 66.9\%.$$

3.10.2.1.3. Determine the grade of virgin asphalt binder to be used in the blend by using the following formula:

$$10^{\log V_r - \frac{100(\log V_r - \log V_b)}{R_1}}, \text{ where}$$

V_r = the viscosity of the recovered RAP asphalt binder from T 316 (Pa·s);
 V_b = the desired viscosity of the virgin asphalt binder and RAP asphalt binder blend from Subsection 3.10.1 (Pa·s); and
 R_1 = the ratio of the virgin asphalt binder to the total asphalt binder (Subsection 3.10.2.1.2).

For example, consider the mixture described in Subsections 3.10.2.1.1 and 3.10.2.1.2. The desired viscosity of the blend is that of a PG 64-22 (0.36 -

0.58 Pa·s), and the viscosity of the recovered RAP asphalt binder ([Subsection 3.10.2](#)) is 1.52 Pa·s. Determine the viscosity of the virgin asphalt binder required to produce a blend of asphalt binder with a viscosity of 0.36 to 0.58 Pa·s (target value of 0.47 Pa·s) as follows:

$$10^{\frac{\log(1.52) - 100[\log(1.52) - \log(0.47)]}{66.9}} = 0.26 \text{ Pa} \cdot \text{s}$$

In this case, with the viscosity's being 0.26 Pa·s, a PG 58-22 (0.26 - 0.35 Pa·s) would be blended with the RAP asphalt binder to produce a blended asphalt binder that would be within acceptable tolerances for a PG 64-22.

- 3.10.2.2. Blend a sample of appropriate size for the battery of analyses described in the following [Subsection 3.10.2.3](#), by weight, of the virgin asphalt binder and recovered asphalt binder at percentages corresponding, respectively, to the values for R_1 , as given in [Subsection 3.10.2.1.2](#), and R_2 , as given below:

$$R_2 = 100 - R_1.$$

For example, since R_1 is 66.9 % as determined in [Subsection 3.10.2.1.2](#), R_2 would be 33.1 %. Therefore, blend a sample of appropriate size containing 66.9 % of the virgin asphalt binder, by weight, and 33.1 % of the recovered (or RAP) asphalt binder, by weight.

- 3.10.2.3. Analyze the sample of blended asphalt binder for viscosity according to T 316 ([Subsection 3.5](#)). This examination is necessary to verify that the blended asphalt binder satisfies the viscosity range of the grade of asphalt binder specified for the particular mixture (as given in [Subsection 3.10.1](#)).
- 3.10.2.4. After verifying that the blended asphalt binder and the gradation of the combined virgin and RAP aggregates satisfies all applicable specifications, determine the JMF according to [KM 64-421](#).

4. PROCEDURE FOR MIX DESIGN -

- 4.1. Analyze the mixture, including the RAP, for aggregate properties according to R 35. Generate, by extraction, an adequate amount of RAP aggregate to blend with the virgin aggregates to obtain samples for aggregate consensus properties.
- 4.1.1. When the RAP contains coarse aggregate, combine the coarse RAP aggregate with the coarse virgin aggregates in the proper proportion. Analyze the blend for coarse-aggregate angularity and flat-and-elongated particles according to R 35.
- 4.1.2. When the RAP contains fine aggregate, combine the fine RAP aggregate with the fine virgin aggregates in the proper proportion. Analyze the blend for fine-aggregate angularity according to R 35. The Department will not require fine RAP aggregate to

be included in the sample tested for sand equivalency.

4.2. Analyze the mixture, including the RAP, for volumetric properties according to R 35.

4.2.1. Use the formulas given in the following subsections to calculate the correct weights for the “specimen-batching” process.

4.2.1.1. To calculate the total specimen weight, use the following formula:

$$W_{ts}=W_{ta}+\frac{W_{ta}P_rP_{sb}}{100^2}, \text{where}$$

- W_{ts} = the total specimen weight (the virgin aggregate + RAP) in g;
 W_{ta} = the total aggregate weight (the virgin aggregate + RAP aggregate), estimated from past mix-design experience or by making test specimens to achieve a height of approximately 115 mm, in g;
 P_r = the percentage of RAP in the mixture; and
 P_{sb} = the AC of the RAP ([Subsection 3.2](#)), in percent.

For example, if 4500 g of total aggregate are required to produce a specimen having a height of 115 mm, calculate the total specimen weight (without the virgin asphalt binder) as follows:

$$W_{ts}=4500+\frac{4500(31)(5.6)}{100^2}=4578 \text{ g.}$$

4.2.1.2. To calculate the weight of virgin aggregate in each specimen, use the following formula:

$$W_{va}=W_{ta}-\frac{W_{ta}P_r(100-P_{sb})}{100^2}, \text{where}$$

- W_{va} = the virgin aggregate weight in g.

For example, consider the weight for W_{ta} , as shown in Subsection 4.2.1.1. The weight of virgin aggregate is equal to:

$$W_{va}=4500-\frac{4500(31)(100-5.6)}{100^2}=3183 \text{ g.}$$

After determining the weight of virgin aggregate required for each specimen, proportion that value appropriately among each applicable sieve size for the mixture in question, after accounting for the “dry-sieve versus wet-sieve” correction, as described in KM 64-411. Use the same procedure as described in [KM 64-411](#) to “weigh up” the virgin-aggregate portion of each mix-design specimen.

4.2.1.3. To calculate the total weight of RAP required for each specimen, use the following formula:

$$W_{tr} = W_{ts} - W_{va}, \text{ where}$$

W_{tr} = the total weight of RAP in g.

For example, knowing the total specimen weight (without the virgin asphalt binder) and the virgin aggregate weight, the total weight of RAP to be included in each specimen is:

$$W_{tr} = 4578 - 3183 = 1395 \text{ g.}$$

After determining the weight of RAP required for each specimen, “weigh out” that value of the total RAP sample, and add it to the virgin-aggregate portion. Ensure that a representative sample of RAP is obtained for each specimen.

4.2.1.4. To calculate the amount of virgin asphalt binder added to each specimen to achieve the desired total AC, use the following formula:

$$W_{vb} = W_{ta} - W_{ts} + \frac{W_{ta} P_{tb}}{100 - P_{tb}}, \text{ where}$$

W_{vb} = the weight of virgin asphalt binder in g; and
 P_{tb} = the percentage of total asphalt binder in the specimen.

For example, suppose that a total AC of 5.0 % is desired for each specimen. The weight of virgin asphalt binder to be added to the virgin aggregate and RAP is:

$$W_{vb} = 4500 - 4578 + \frac{4500(5.0)}{100 - 5.0} = 159 \text{ g.}$$

After determining the weight of virgin asphalt binder required for each specimen, introduce that value to the virgin-aggregate and RAP portions of the specimen. Heat the virgin aggregate and asphalt binder to the mixing temperature prior to the mixing process. Heat the RAP to a temperature of 230 ± 5 °F for no more than two hours. Exercise great care in order to prevent overheating the RAP. Conform to the mixing temperature given in KM 64-411 for the PG binder specified in the mixture’s bid item. Do not reheat previously heated RAP to use it again.

After laboratory mixing and prior to compaction, short-term condition the mixture of virgin and RAP material according to R 30. Use the same short-term conditioning procedure for the specimens containing RAP as for a mixture containing all virgin materials. Conform to the compaction temperature given in [KM 64-411](#) for the PG binder specified in the mixture’s bid item.

4.2.2. To evaluate the mixture for the percentage of voids-in-mineral aggregate (% VMA) and percentage of voids filled with asphalt (% VFA), calculate the combined bulk specific gravity, G_{sb} , of the aggregate (virgin aggregate and RAP aggregate).

4.2.2.1. Determine the bulk specific gravity of each individual virgin aggregate according to T 84 and T 85, as applicable.

4.2.2.2. Estimate the bulk specific gravity of the RAP by following the directions given below:

4.2.2.2.1. Determine the theoretical maximum specific gravity of at least two representative samples of the RAP according to T 209. Perform the *Supplemental Procedure for Mixtures Containing Porous Aggregate* from T 209 on each sample. Average the results of the two samples to obtain the value for further calculations.

4.2.2.2.2. Determine the effective specific gravity of the RAP aggregate, G_{se} , by using the following formula:

$$G_{se} = \frac{100 - P_b}{\frac{100}{G_{mm}} - \frac{P_b}{G_b}}, \text{ where}$$

G_{mm} = the theoretical maximum specific gravity of the RAP aggregate (Subsection 4.2.2.2.1);

P_b = the AC of the RAP in percent; and

G_b = the specific gravity of the RAP asphalt binder (usually 1.03).

4.2.2.2.3. Estimate the amount of absorbed asphalt, based on experience, and “back-calculate” the bulk specific gravity of the RAP aggregate. Determine the bulk specific gravity, G_{sb} , of the RAP aggregate using the following formula:

$$G_{sb} = \frac{100G_{se}G_b}{P_{ba}G_{se} + 100G_b}, \text{ where}$$

G_{se} = the effective specific gravity of the RAP aggregate (Subsection 4.2.2.2.2); and

P_{ba} = the percentage of absorbed asphalt in the RAP, by weight of the total aggregate.

If the P_{ba} cannot be determined or reasonably estimated, use a value of 0.5 %.

For example, consider RAP that has a G_{mm} of 2.450 and an asphalt binder

KM 64-427-05

content, P_{sb} , of 5.6 %, as explained in Subsection 3.10.2.1.1. Estimate its G_{sb} as follows:

$$G_{se} = \frac{100 - 5.6}{\frac{100}{2.450} - \frac{5.6}{1.03}} = 2.668$$

If the estimated P_{ba} is 0.5 %, using the formula given in Subsection 4.2.2.2.3:

$$G_{sb} = \frac{100(2.668)(1.03)}{0.5(2.668) + 100(1.03)} = 2.634$$

Utilize this G_{sb} value for the RAP, along with the G_{sb} values of each individual virgin aggregate described in Subsection 4.2.2.1, to obtain a combined G_{sb} for the entire mixture. Further utilize this value, calculated according to R 35, for % VMA and % VFA determinations.

APPROVED



DIRECTOR
DIVISION OF MATERIALS

DATE

12/28/04

Kentucky Method 64-427-05
Revised 12/28/04
Supersedes KM 64-427-04
Dated 03/04/04

WET-SIEVE ANALYSIS OF AGGREGATES USED IN ASPHALT MIXTURES

1. SCOPE:

- 1.1. This test method covers the procedure for the determination of the particle-size distribution of fine and coarse aggregates used in asphalt mixtures. Obtain the sample of aggregate for the wet-sieve analysis from one of the following sources:
 - 1.1.1. A sample of asphalt mixture extracted in accordance with [Kentucky Method \(KM\) 64-405](#), *Extraction of Binder From Asphalt Paving Mixtures*.
 - 1.1.2. A sample of asphalt mixture ignited in accordance with AASHTO T 308,
Determining the Asphalt Binder Content of Hot-Mix Asphalt (HMA) by the Ignition Method.
 - 1.1.3. The hot bins of the asphalt mixing plant.
 - 1.1.4. The cold feeds of the asphalt mixing plant.
 - 1.1.5. The stockpiles at the asphalt mixing plant.
- 1.2. Use the results to determine compliance of the particle-size distribution with the applicable specification requirements and to provide the necessary data for the control of the production of asphalt mixtures.

NOTE 1: As another option, use the procedure described in [KM 64-620](#), *Wet Sieve Analysis of Fine and Coarse Aggregate*, in lieu of this method to determine the percentage of minus-No. 200 material by wet-sieve analysis.

2. APPARATUS:

- 2.1. Provide sieves conforming to AASHTO M 92, *Wire-Cloth Sieves for Testing Purposes*.
- 2.2. Provide scales capable of weighing 5000 g accurately, sensitive to 1.0 g.
- 2.3. As an option, provide a mechanical shaker.
- 2.4. Provide a hot plate or oven capable of drying material to a constant weight at 230 ± 9 °F.
- 2.5. Provide miscellaneous equipment such as drying pans; a spatula; small, stiff brush; small, soft brush; large, long-handled spoon; and syringe.
- 2.6. As an option, provide a wetting agent.
- 2.7. Provide a pan or container of a size sufficient to contain the sample, covered with water, and to permit vigorous agitation without a loss of any part of the sample or water.
- 2.8. Provide an adequate and reliable source of clean water.

3. SAMPLE:

- 3.1. Ensure the sample consists of the entire test portion of aggregate after completion of the asphalt binder content (AC) determination by [KM 64-405](#). Conform to [KM 64-425](#), *Sampling Asphalt Mixtures*, for the sampling procedure and test-portion size for testing by [KM 64-405](#).
- 3.2. Ensure the sample consists of the entire test portion of aggregate after completion of the AC determination by T 308. Conform to T 308 for the sampling procedure and test-portion size when performing the ignition method.
- 3.3. When sampling aggregate from the hot bins or cold feeds of the asphalt mixing plant, conform to [KM 64-407](#), *Sieve Analysis of Aggregate From Asphalt Mixing Plants*, for the sampling procedure and [KM 64-425](#) for the test-portion size.
- 3.4. When sampling aggregate from the stockpiles at the asphalt mixing plant, conform to AASHTO T 2, *Sampling of Aggregates*, for the sampling procedure and [KM 64-425](#) for the test-portion size.

4. PROCEDURE:

- 4.1. Dry the sample at 230 ± 9 °F to a constant weight, and record the weight.
- 4.2. Place the test portion, after drying and weighing, in a container, and cover it with water. If desired, add a sufficient amount of wetting agent to ensure a thorough separation of the material finer than the No. 200 sieve from the coarser particles. Use a large spoon to stir and agitate the aggregate in the wash water. Agitate the contents of the container vigorously to bring the material finer than the No. 200 sieve into suspension for removal by decantation of the wash water; immediately pour the wash water over a nest of sieves consisting of a No. 16 and No. 200 sieve, in that order. Take care to avoid, as much as possible, the decantation of the coarser particles of the sample.
- 4.3. Repeat the operation until the wash water is clear.
- 4.4. Return all material retained on the nested sieves to the container. Dry the washed aggregate in the container to a constant weight, and weigh it to the nearest 1.0 g.
- 4.5. Separate the dried aggregate into sizes, either by hand or a mechanical apparatus, using such sieves as are necessary to determine compliance with the specifications for the material in question. Perform the sieving operation by means of a lateral and vertical motion of the sieve, accompanied by a “jarring” action so as to keep the material moving continuously over the surface of the sieve. Do not manipulate aggregate fragments through the sieve by hand. Continue sieving until not more than 0.5 percent, by weight of the residue, on any sieve passes the sieve during a one-minute sieving time. When using a mechanical shaker, sieve the aggregate a minimum of five minutes. Verify the thoroughness of sieving by the “hand” method of sieving as described above.
- 4.6. Determine and record the weight of material retained on each sieve. Add the weight of dry material passing the No. 200 sieve by dry sieving to the weight of the material removed by washing in order to obtain the total passing the No. 200 sieve.

5. CALCULATION:

5.1. Determine the amount of material removed by washing with water using the following formula:

$A = B - C$, where:

A = weight of the material finer than the No. 200 sieve by washing;

B = original dry weight of the aggregate after the removal of the asphalt binder; and

C = dry weight of the sample after washing.

NOTE 2: Add the weight removed by washing to the weight of dry material passing the No. 200 sieve (pan material) by dry sieving to obtain the total passing the No. 200 sieve.

5.2. Perform the gradation calculation using one of the following two methods:

5.2.1. Individual weighing method

5.2.1.1. As an option, complete the sieve analysis using this method in which the percent retained on each sieve is calculated by dividing the weight of the material retained on a sieve by the original dry weight of the aggregate, as given below:

Percent Retained on a Given Sieve = 100 (X/Y), where:

X = the weight of material retained on a given sieve (g); and

Y = the original dry weight of the aggregate (g).

5.2.1.2. Calculate the percent passing a given sieve by subtracting the percent retained on that sieve from the total percent passing the next larger sieve in the sieve-series used, as given below:

Percent Passing Given Sieve =

Percent Passing Sieve Just Larger in Sequence – Percent Retained on Given Sieve

5.2.2. Cumulative weighing method

5.2.2.1. As an option, complete the sieve analysis using this method in which the cumulative percent retained for each sieve is calculated by dividing the cumulative retained weight on a given sieve by the total weight of the sample, as given below:

Cumulative Percent Retained on a Given Sieve = 100 (X/Y), where:

X = the cumulative weight of material retained on a given sieve (g); and

Y = the total weight of the sample (g).

5.2.2.2. Calculate the percent passing a given sieve by subtracting the cumulative percent retained on that sieve from 100, as given below:

$$\text{Percent Passing Given Sieve} = 100 - \text{Cumulative Percent Retained on Given Sieve}$$

6. WEIGHT LOSS: Ensure the maximum allowable loss incurred during the sieving operations is less than 0.5 percent of the total dry weight of the portion after washing with water. Add all losses of 0.5 percent or less to the weight of the material retained in the pan.
7. REPORT:
 - 7.1. Report the final gradation result on all sieves, except the No. 200 sieve, to the nearest whole number. Report the gradation on the No. 200 sieve to the nearest 0.5 percent. For example, report a result calculated to be 3.2 as 3.0, but report a result calculated to be 3.3 as 3.5.
 - 7.2. Although either the individual or cumulative weighing method is acceptable for calculating the gradation as described in Subsection 5.2 of this method, the [Asphalt Mixtures Acceptance Workbook \(AMAW\)](#), required for the submission of test data, uses the cumulative weighing method.

APPROVED



DIRECTOR
DIVISION OF MATERIALS

DATE

02/21/08

Kentucky Method 64-433-08
Revised 02/21/08
Supersedes KM 64-433-03
Dated 01/12/03

DETERMINATION OF MOISTURE CONTENT IN ASPHALT MIXTURES (RAPID FIELD TEST)

1. SCOPE:

- 1.1. This method is a rapid field test for measuring the percent of moisture present in an asphalt mixture.
- 1.2. Use the results of this test to correct the asphalt binder content (AC) as determined by [Kentucky Method \(KM\) 64-405](#), *Extraction of Binder From Asphalt Paving Mixtures*; [KM 64-436](#), *Asphalt Binder Content Determination of Asphalt Mixtures by Plant Recordation*; [KM 64-437](#), *Determination of Asphalt Binder Content of Asphalt Mixtures Using the Nuclear Asphalt Content Gauge*; [KM 64-438](#), *Asphalt Binder Content Determination of Asphalt Mixtures Based on the Maximum Specific Gravity*; or AASHTO T 308, *Determining the Asphalt Binder Content of Hot Mix Asphalt (HMA) by the Ignition Method*.

2. APPARATUS:

- 2.1. Balance or Scale: Provide a device capable of accurately weighing 5000 g, sensitive to 0.1 g.
- 2.2. Hot Plate or Oven: Provide a unit capable of heating an asphalt mixture to $230 \pm 9^\circ\text{F}$.
- 2.3. Miscellaneous Equipment: Provide insulated gloves and flat-bottom, metal, drying pans.

3. SAMPLE: Refer to [KM 64-425](#), *Sampling Asphalt Mixtures*, for the sampling procedure and test-portion size.

NOTE 1: Do not use the test portion from a moisture content determination for any method of AC determination due to possible migration and absorption of asphalt binder.

4. PROCEDURE:

- 4.1. Determine the mass of the drying pan to the nearest 0.1 g, and record the mass of the pan.
- 4.2. Place the sample in the pan, and determine the mass of it to the nearest 0.1 g. Record this mass as the “pan and sample” mass.
- 4.3. Place the pan and sample on the hot plate or in the oven.
- 4.4. Dry the sample to a constant mass at $230 \pm 9^\circ\text{F}$, and record the mass. “Constant mass” is defined as the point when additional drying does not alter the moisture content by more than 0.1 percent when evaluated at 15-min intervals.

5. CALCULATIONS AND REPORT:

5.1. Calculate the moisture content as follows:

$$\text{Moisture content (\%)} = 100 \left(\frac{A-B}{A} \right),$$

where:

A = Mass of the sample before drying minus the mass of the pan; and

B = Mass of the sample after drying minus the mass of the pan.

5.2. Report the moisture content to the nearest 0.1 percent on the appropriate [Asphalt Mixtures Acceptance Workbook \(AMAW\)](#).

APPROVED William Broyles
DIRECTOR
DIVISION OF MATERIALS

DATE 05/13/09

Kentucky Method 64-434-09
Revised 05/13/09
Supersedes KM 64-434-04
Dated 03/05/04

METHOD FOR ACCEPTANCE OF ASPHALT MIXTURES BY MIXTURE PROPERTY ANALYSIS

1. SCOPE: This method documents the procedure for volumetric analysis of selected properties of plant-produced asphalt mixtures.
2. EQUIPMENT AND FACILITIES: Furnish all resources including equipment, lab facilities, and personnel necessary to comply with the Quality Control Plan.
 - 2.1. Ensure the laboratory facility conforms to the requirements of Subsection 401.02.01 A) of the Department of Highway's (Department) *Standard Specifications for Road and Bridge Construction (Specifications)*.
 - 2.2. Provide a Superpave gyratory compactor, four accompanying molds, paper disks, and specimen-extruding system conforming to AASHTO T 312, *Preparing and Determining the Density of Hot-Mix Asphalt (HMA) Specimens by Means of the Superpave Gyratory Compactor*.
 - 2.3. Maximum specific gravity (G_{mm}) equipment. Provide a vacuum device, pycnometer, mechanical agitator, and manometer conforming to AASHTO T 209, *Theoretical Maximum Specific Gravity and Density of Bituminous Paving Mixtures*.
 - 2.4. Asphalt content (AC) determination equipment. Depending on the selected method of AC determination, provide equipment suitable to determine the AC by Kentucky Method (KM) 64-405, *Extraction of Binder From Asphalt Paving Mixtures*; KM 64-436, *Asphalt Binder Content Determination of Asphalt Mixtures by Plant Recordation*; KM 64-437, *Determination of Asphalt Binder Content of Asphalt Mixtures Using the Nuclear Asphalt Content Gauge*; KM 64-438, *Asphalt Binder Content Determination of Asphalt Mixtures Based on the Maximum Specific Gravity*; or AASHTO T 308, *Determining the Asphalt Binder Content of Hot-Mix Asphalt (HMA) by the Ignition Method*.
 - 2.5. Oven. Furnish suitable ovens of sufficient size, providing adequate maintenance of temperature, and in a convenient location.
 - 2.6. Scales. Provide scales having a capacity of 10 kg and an accuracy of 0.1 g.
 - 2.7. Water bath. Furnish a suitable water bath of sufficient size, providing adequate maintenance of temperature at 77 ± 1.8 °F, and with a constant water level for determining the unit weight of compacted specimens.
 - 2.8. Miscellaneous equipment. Provide other items including pans, thermometers, hot plates, and spoons needed to prepare volumetric specimens and to determine the G_{mm} of asphalt mixtures.

3. SAMPLING:

- 3.1. Obtain samples at a frequency of one per each 1000-ton subplot according to Section 402 of the [Department's Specification](#). Select the subplot sample according to [KM 64-113](#), *Sampling Materials by Random Number Sampling*.
- 3.2. Select the sample location, and obtain the sample, according to [KM 64-425](#), *Sampling Asphalt Mixtures*.
- 3.3. Obtain a field sample size of approximately 70 lb_m.
- 3.4. Use the specimen test portion weights specified in the mix design on the "Asphalt-Mixture-Design Results" form, or "MixPack" spreadsheet, if available. If no weight is available, use 4600 g. Adjust the specimen test portion weights according to the following formula, if necessary.

$$\text{Corrected Specimen Weight (g)} = \frac{115(\text{Estimated Specimen Weight in g})}{\text{Height of Specimen in mm}}$$

- 3.5. Use G_{mm} test portions conforming to the minimum sample sizes in AASHTO T 209.

4. PROCEDURE:

- 4.1. Thoroughly blend the field samples with a large spoon or scoop.
- 4.2. Compact and test two gyratory specimens.
 - 4.2.1. Weigh into a tared bowl, pan, or onto a durable piece of paper, the required test portion for each specimen.
 - 4.2.2. Place a paper disk in the bottom of the preheated mold assembly; then, carefully pour the weighed test portion into the mold in one complete mass.
 - 4.2.3. Allow the specimen to cool until the temperature of the specimen is at the required compaction temperature. If the temperature of the specimen is below the required compaction temperature, place the specimen in an oven set at 100 °F above the compaction temperature. Check the temperature of the specimen after 30 ± 5 minutes. If the temperature of the specimen is at the required compaction temperature, proceed to the next step. If the temperature of the specimen is still below the required compaction temperature, discard the specimen, and obtain more mixture for another volumetric specimen. If this reheating is required, document on the [Asphalt Mixtures Acceptance Workbook \(AMAW\)](#) that the randomly selected sample was not utilized due to temperature loss and the random number for the sample for that subplot was adjusted.
 - 4.2.4. Place a paper disk on top of the specimen, and compact it immediately. Use the number of gyrations as indicated by the ESAL class in the mixture's bid item.

- 4.2.5. Remove the paper disk from the top of the specimen after compaction. Set the specimen aside to cool. When the specimen has cooled sufficiently to not be damaged by the removal effort, extrude it from the mold; remove the paper disk from the bottom of the specimen, and label the specimen appropriately.
- 4.2.6. Determine the bulk specific gravity (G_{mb}) of the specimens according to AASHTO T 166, *Bulk Specific Gravity of Compacted Asphalt Mixtures Using Saturated Surface-Dry Specimens*.
- 4.2.7. Determine the unit weight of the specimens by multiplying the G_{mb} of the specimens by the density of water at 77 °F (normally considered to be 62.4 lb_m/ft³).
- 4.3. Perform the G_{mm} analysis.
 - 4.3.1. Weigh three G_{mm} samples from the remainder of the field sample after placing the volumetric specimens in the molds. Use the sample size as stated in [Subsection 3.5](#) of this method.
 - 4.3.2. Determine the G_{mm} of two of the samples according to AASHTO T 209. When performing a G_{mm} test on materials considered to be absorptive (e.g., mixtures containing slag, some dolomites, etc.), follow the “Supplemental Procedure for Mixtures Containing Porous Aggregate” of AASHTO T 209. Retain the third G_{mm} sample for potential testing at a later time.
- 4.4. Retain at the compaction temperature, and appropriately label, the remaining portion of the field sample for possible additional testing.

5. ACCEPTANCE TOLERANCES:

- 5.1. Average the unit weight of the two specimens to determine a single test result.
 - 5.1.1. Ensure the two specimens have a unit weight within ± 1.5 lb_m/ft³ of each other. If the specimens have unit weights outside of this tolerance, obtain more mixture from that quantity of material retained earlier, and compact and analyze another volumetric specimen.
 - 5.1.2. Next, average the unit weights of all three specimens. Ensure each individual specimen has a unit weight within ± 1.5 lb_m/ft³ of the average value. Consider any specimen outside this tolerance invalid. In this case, average the remaining two specimens for a single test result.

Example #1: Specimen #1: 148.7 lb_m/ft³
 Specimen #2: 148.1 lb_m/ft³ (tolerance satisfied, use both specimens)

$$\text{Average} = 148.4 \text{ lb}_m/\text{ft}^3$$

Report this test result (148.4 lb_m/ft³) on the AMAW.

KM 64-435-05

Example #2: Specimen #1: 147.3 lb_m/ft³
Specimen #2: 150.5 lb_m/ft³ (tolerance not satisfied, compact another specimen)
Specimen #3: 148.4 lb_m/ft³

Average = 148.7 lb_m/ft³

Specimen #2 is 1.8 lb_m/ft³ from the average; therefore, delete it, and report the new average as 147.9 lb_m/ft³. Report this test result (147.9 lb_m/ft³) on the AMAW.

Example #3: Specimen #1: 147.0 lb_m/ft³
Specimen #2: 148.6 lb_m/ft³ (tolerance not satisfied, compact another specimen)
Specimen #3: 150.2 lb_m/ft³

Average = 148.6 lb_m/ft³

Due to the variations from the average, consider this sample invalid, and obtain another field sample for testing.

5.2. Average the two G_{mm} test results for each field sample to obtain one result for further calculations.

5.2.1. After determining the G_{mm} values from the field sample, ensure the difference between the two results is no more than 0.015.

5.2.2. When the G_{mm} values vary more than 0.015, perform a third G_{mm} test to determine which of the two previous G_{mm} values may be in error. When performing a third test, use the third portion of the same field sample as used for the previous G_{mm} samples.

5.2.3 Use the following examples to determine which results to use for the final calculations:

Example #1: G_{mm} #1 = 2.500
G_{mm} #2 = 2.514 (tolerance satisfied, use both specimens)
Average = 2.507

Example #2: G_{mm} #1 = 2.500
G_{mm} #2 = 2.516 (tolerance not satisfied, perform a third test)
G_{mm} #3 = 2.504 (average G_{mm} #1 and G_{mm} #3)

Average = 2.502 (use this value)

Example #3: $G_{mm} \#1 = 2.500$
 $G_{mm} \#2 = 2.516$ (tolerance not satisfied, perform a third test)
 $G_{mm} \#3 = 2.508$ (average all three)

Average = 2.508 (use this value)

Example #4: $G_{mm} \#1 = 2.500$
 $G_{mm} \#2 = 2.540$
 $G_{mm} \#3 = 2.522$

Due to the variability, consider these test results invalid, and obtain additional test portions from the field sample if sufficient material remains. If insufficient material remains, obtain another field sample, and repeat the G_{mm} analyses.

6. CALCULATIONS: Perform all volumetric calculations in accordance with AASHTO R 35, *Superpave Volumetric Design for Hot-Mix Asphalt (HMA)*.
7. REPORT:
 - 7.1. Report results on the appropriate AMAW.
 - 7.2. Report the percentage of air voids (% AV), percentage of voids-in-the mineral aggregate (% VMA), and AC to the nearest 0.1 %.
 - 7.3. Report the G_{mm} values to the nearest thousandth (e. g., 2.459).

APPROVED



DIRECTOR
DIVISION OF MATERIALS

DATE

12/28/04

Kentucky Method 64-435-05
Revised 12/28/04
Supersedes KM 64-435-03
Dated 01/14/03

ASPHALT BINDER CONTENT DETERMINATION OF ASPHALT MIXTURES
BY PLANT RECORDATION

1. SCOPE:
 - 1.1. This method documents the procedures for the determination of the asphalt binder content (AC) of asphalt mixtures by means of the asphalt mixing plant's recordation system. When selecting this option, determine the AC on the basis of the plant's recordation of the asphalt binder quantity.
 - 1.2. Section and subsection references herein are to the Kentucky Transportation Cabinet's (Cabinet) *Standard Specifications for Road and Bridge Construction (Specifications)*.
2. SIGNIFICANCE AND USE: This method is one of a group of approved means of determining the AC of asphalt mixtures. Other means include Kentucky Method (KM) 64-405, *Extraction of Binder From Asphalt Paving Mixtures*; KM 64-437, *Asphalt Binder Content Determination of Asphalt Mixtures by the Nuclear Asphalt Content Gauge (NACG)*; KM 64-438, *Asphalt Binder Content Determination of Asphalt Mixtures Based on the Maximum Specific Gravity*; or AASHTO T 308, *Determining the Asphalt Binder Content of Hot-Mix Asphalt (HMA) by the Ignition Method*. Use KM 64-436 for acceptance, process-control, or informational testing.
3. QUALITY CONTROL PLAN:
 - 3.1. When so desired, indicate on the submitted Quality Control Plan (QCP), TC 64-418 form, that plant recordation by printed ticket will be the primary means of AC determination. Further indicate the alternate, or "backup," means of AC determination if the plant recordation system should break down or malfunction.
 - 3.2. The Cabinet will consider the TC 64-418 form to be part of the plant acceptance file. The Cabinet will maintain the TC 64-418 form on file at the District Materials office. Prominently post the TC 64-418 form at the field laboratory. Document all changes in the TC 64-418 form, and submit a revised form specifying the changes for approval. If the plan is to change from project to project, include the revised TC 64-418 form as a part of each project's file.
4. APPROVAL:
 - 4.1. Prior to utilization of this means of AC determination, the Cabinet will inspect and approve the recordation system. Produce sample tickets for review by the Cabinet. Ensure these tickets contain the required information listed later in this method. Demonstrate and document the tolerance compliance for all components. The Cabinet will include this documentation in the plant acceptance file.

- 4.2 Ensure the weights comply with the tolerances specified in Subsection 401.02.02 for batch plants.
- 4.3 For drum plants or any type of plant utilizing an asphalt flowmeter, ensure the asphalt control unit complies with the tolerances specified in Subsection 401.02.01 H).
- 4.4 For drum plants or other types of plants that utilize belt scales for production control, ensure the belt scales/weighing system complies with the tolerances specified in Subsection 401.02.04).
- 4.5 Conform to the requirements for scale certification specified in subsection 109.01.02.
5. SCALE CERTIFICATION AND SYSTEM CALIBRATION: Conform to the requirements for scale certification and system calibration specified in the [Specifications](#).
6. RECORDATION REQUIREMENTS:
 - 6.1. Ensure an automatic digital record can be produced for each batch or specified interval, or on demand, for asphalt mixtures produced. Use the automatic printer system in conjunction with the automatic batching/proportioning and mixing control systems previously approved by the Engineer.
 - 6.2. Ensure the digital record is clearly legible and includes the following: the Contractor's identification [company name, SiteManager producer code number, location, etc.], date, time, project number or code (proposal code number), and type of mixture or SiteManager code for the mixture produced.
 - 6.3. For batch plants, ensure the record further includes: the tare weight of the aggregate weigh box, tare weight of the asphalt weigh bucket, cumulative or net weights as batched for each bin including mineral fillers, liquid anti-stripping additives blended in-line, recycled-asphalt pavement (RAP), weight of asphalt, and a batch total for all net ingredients.
 - 6.4. For drum plants, ensure the record further includes: the dry aggregate weight of aggregate flow from each bin or the accumulated weight of all aggregates on the collector belt, and the asphalt flow rate. When using mineral filler, RAP, or liquid anti-stripping additives blended in-line, record the flow rate of each component. Include the accumulated total for aggregate, asphalt, and total mix.
 - 6.5. The Cabinet may approve deviations from the previously stated recordation requirements upon inspection by the Engineer.
 - 6.6. For all projects utilizing plant recordation for AC determination, supply one printed ticket for each 15-minute production interval. Supply printed tickets for each batch or lesser time intervals if the system design and programming so dictate. Analyze all printed tickets to ensure compliance with the tolerances.

7. VERIFICATION OF ACCURACY:

- 7.1 When the Contractor elects to use recordation for AC determination, the Cabinet will perform a comparison by another method [solvent extractions when performed by the Contractor and witnessed by Cabinet personnel, NACG, ignition oven, or back-calculation from the maximum specific gravity (G_{mm})] for the initial verification of accuracy.
- 7.2 The Cabinet will perform a minimum of three suitable comparisons. The average of the three comparisons shall be within ± 0.3 percent of the recorded value. Further, the three AC values shall be within ± 0.3 percent of each other.
- 7.3 The Cabinet will correct the verification values determined according to either [KM 405](#), [KM 437](#), [KM 438](#), or [T 308](#) for the moisture content [determined according to [KM 64-434](#), *Determination of Moisture Content in Asphalt Mixtures (Rapid Field Test)*].
- 7.4 The Cabinet will investigate actual deviations outside ± 0.3 percent. In these instances, complete the necessary corrections or adjustments. Upon completion of these corrections, the Cabinet will perform additional verification testing.

NOTE 1: When deviations larger than ± 0.3 percent occur, the Cabinet will determine whether the plant production facilities are inaccurate or the ability to verify the accuracy of the asphalt supply system has been exceeded. When this condition (average of three tests deviating by more than ± 0.3 percent) occurs, the Cabinet will perform further evaluations to investigate the cause of the deviation. The Cabinet may require monitoring scale pulls, verifying scale accuracy (hanging test weights or rechecking scales), or calibrating the asphalt delivery system.

- 7.5 In addition to the above-described initial verification, validate the accuracy of the proportioning system of the plant. The Engineer will perform a minimum of one validation for each 12,000 tons of production. Validate the AC by one of the approved means of AC determination or by attaching test weights. The validation of the aggregate-proportioning system, if needed, shall consist of hanging test weights, recalibration of the aggregate-feed rate, or other means proposed on the TC 64-418 form and approved by the Engineer. Document such validations, and include the results as part of the project acceptance record, on the appropriate [Asphalt Mixtures Acceptance Workbook \(AMAW\)](#). When validating the recordation system, ensure the test result falls within ± 0.3 percent of the recorded value. If larger deviations are found, perform adjustments or corrections until achieving a satisfactory verification.
- 7.6 Include all records or documents of testing performed to demonstrate accuracy in the plant acceptance files.

8. PRODUCTION ACCEPTANCE:

- 8.1. Select the actual ticket (or batch, as applicable) to be used for determining the AC on a random basis according to the provisions of [KM 64-113](#), *Sampling Materials by Random Number Sampling*.

- 8.2. For AC determination, review the printed tickets at the frequency specified in Section 402.
- 8.3. Ensure the AC is within the allowable tolerances for the mixture specified.

NOTE 2: The AC of the mixture, as documented by printed ticket, should vary equally between values higher and lower than the target value. If inspection of the tickets indicate that the results are skewed from a normal distribution, perform corrective action or adjustments.

- 8.4. When deviations outside the allowable tolerances occur, immediately review additional tickets to determine the extent of the problem.
- 8.5. If the problem occurs during production, immediately acquire a sample of mixture, and retain it for check-testing. Document that a check sample has been obtained on the AMAW.
- 8.6. Cease production, as specified in Section 402, if corrective actions do not indicate that material within specifications is being produced.

9. SPECIAL CONDITIONS FOR MIXTURES CONTAINING RAP:

- 9.1. When using RAP, furnish AC test results from extraction tests from three representative samples of the RAP when submitting the “Asphalt-Mixture-Design Results” form, or “MixPack” spreadsheet, for evaluation. Review these values to determine the consistency of the RAP and establish the percentage of recycled asphalt binder contributed to the total mixture. Consider the average AC of the original three samples to be the target AC of the RAP, and use this value to calculate the percentage of total asphalt binder in the mixture.
- 9.2. Perform one extraction test for determining the AC of the RAP during the first day of production. Perform an additional extraction test for every 1000 tons of RAP used in the mixture thereafter. If any RAP extraction test result deviates more than ± 0.5 percent from the target RAP AC, perform an additional extraction test on the RAP, and average the two test results to establish a new target RAP AC.

10. CALCULATIONS AND REPORT:

- 10.1. Determine the AC of the batch or quantity of material from the printed record.
- 10.2. For batch plants, calculate the AC by taking the amount of asphalt binder used for the batch and dividing by the total batch size, as described in the following formulas:

$$\% AC Without RAP = 100 \left(\frac{W_1}{W_2} \right), or$$

$$\% AC With RAP = 100 \left(\frac{W_1 + R_1 R_2}{W_2} \right),$$

where:

W_1 = Total weight of virgin asphalt binder in the batch (lb_m);

W_2 = Total batch size (lb_m);

R_1 = Total weight of RAP in the batch (lb_m); and

R_2 = AC of the RAP (%).

- 10.3. For drum plants, record the AC as an actual percentage for the quantity of mixture produced or as a flowrate of the asphalt binder. In the case of recordation as a percentage, simply record the AC accordingly. In the case of recordation as a flow rate, calculate the AC by taking the tons per hour of asphalt binder used and dividing by the total tons per hour of the mixture produced, as described in the following formulas:

$$\% \text{ AC Without RAP} = 100 \left(\frac{W_3}{W_4} \right), \text{ or}$$

$$\% \text{ AC With RAP} = 100 \left(\frac{W_3 + R_2 R_3}{W_4} \right),$$

where:

W_3 = Tons per hour of virgin asphalt binder;

W_4 = Total tons per hour of the mixture produced; and

R_3 = Total tons per hour of RAP.

- 10.4. Report the AC to the nearest 0.1 percent on the applicable AMAW.

APPROVED

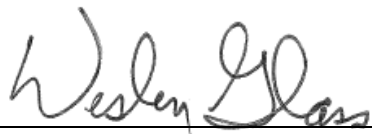

DIRECTOR
DIVISION OF MATERIALS

DATE

02/21/08

Kentucky Method 64-436-08
Revised 02/21/08
Supersedes KM 64-436-03
Dated 01/16/03

DETERMINATION OF ASPHALT BINDER CONTENT OF ASPHALT MIXTURES
USING THE NUCLEAR ASPHALT CONTENT GAUGE

1. SCOPE:
 - 1.1. This method describes the requirements for the determination of the asphalt binder content (AC) of asphalt mixtures using the nuclear asphalt content gauge (NACG).
 - 1.2. This method is derived from AASHTO T 287, *Asphalt Cement Content of Asphalt Concrete Mixtures by the Nuclear Method*.
 - 1.3. If unfamiliar with the operation of NACGs, review the operator's manual carefully.
 - 1.4. Due to the possession and use of radioactive sources, maintain a specific license issued by the United States Nuclear Regulatory Commission (Commission), equivalent-agreement, state-licensing agency. Obtain the appropriate licenses according to the provisions of the Kentucky Cabinet for Human Resources Administrative Radiation Regulations (Regulations).
 - 1.5. When transporting a NACG, ensure the correct documents according to the Commission and the Regulations are readily accessible to the driver.
 - 1.6. Ensure NACG operators wear an approved form of a radiation-dosimetry film badge with a neutron chip capable of monitoring the occupational radiation exposure. When not in use, do not store the badge with the NACG.
 - 1.7. To maintain compliance with a Radioactive Materials License, properly store the instrument containing the radioactive material. In general, store the NACG no closer than 15 feet from the nearest full-time work station.
2. SIGNIFICANCE AND USE: This method is one of a group of approved means of determining the AC of asphalt mixtures. Other means include [Kentucky Method \(KM\) 64-405](#), *Extraction of Binder From Asphalt Paving Mixtures*; [KM 64-436](#), *Asphalt Binder Content Determination of Asphalt Mixtures by Plant Recordation*; [KM 64-438](#), *Asphalt Binder Content Determination of Asphalt Mixtures Based on the Maximum Specific Gravity (MSG)*, or AASHTO T 308, *Determining the Asphalt Binder Content of Hot-Mix Asphalt (HMA) by the Ignition Method*. Use [KM 64-437](#) for acceptance, process-control, or informational testing.
3. OPERATIONAL NOTES:
 - 3.1. Since a NACG measures the total amount of hydrogen in the sample, this procedure is sensitive to changes in moisture content. Both asphalt binder and water contain hydrogen. So, unless the test sample is completely free of moisture, determine the moisture content according to [KM 64-434](#), *Determination of Moisture Content in Asphalt Mixtures*

(*Rapid Field Test*), and make a correction to compensate for the moisture.

- 3.2. Keep any other source of neutron radiation at least 30 ft. away from the NACG. Do not place the equipment where large amounts of hydrogen-containing material (for example, asphalt binder, water, or plastic materials) may be moved during the calibration or testing procedures.

4. EQUIPMENT:

- 4.1. Gauge: Provide a NACG conforming to AASHTO T 287. Furnish a printer for recording all values.
- 4.2. Straightedge: Provide a stiff, steel straightedge, approximately 18 in. in length.
- 4.3. Compaction plate: Provide a piece of plywood, 3/4 in. or thicker, or a metal plate, 3/8 in. or thicker, having an area slightly larger than the top of the sample pans. Ensure the plywood is smooth and solid.
- 4.4. Provide a balance, capable of weighing to 15 kg, accurate to 1.0 g.
- 4.5. Provide an oven, capable of heating to 300 ± 5 °F.
- 4.6. Provide assorted spoons, mixing bowls, thermometers, and a trowel.
- 4.7. Provide the NACG manufacturer's instructional manual.

5. SAMPLING:

- 5.1. Obtain samples of aggregates according to AASHTO T2, *Sampling of Aggregates*.
- 5.2. For acceptance testing, select the actual batch or increment of material for determining the AC on a random basis according to [KM 64-113](#), *Sampling Materials by Random Number Sampling*.
- 5.3. Obtain samples of asphalt mixtures according to [KM 64-425](#), *Sampling Asphalt Mixtures*.

6. CALIBRATION:

- 6.1. This procedure is sensitive to the type of aggregate, percentage and source of asphalt binder, and aggregate gradation. Therefore, develop a calibration curve for each mix. Obtain a dry aggregate reading often enough to ensure that changes in aggregate are detected (see [Subsection 9.2](#) of this method). If a significant change ($\pm 1.0\%$) in this count occurs, perform a new calibration.

NOTE 1: When using the NACG as the primary means of AC determination (as specified in the quality control plan), calibrate the mixture. Provide the calibration information to Kentucky Transportation Cabinet (Cabinet) personnel as specified in [Subsection 10.2](#) of this method.

- 6.2. Obtain aggregate samples, and blend the aggregates in the proper proportions. Obtain enough aggregate for a minimum of three samples, approximately 65 lb_m.
- 6.3. Place the dried, heated aggregate in a tared sample pan in three equal layers. For the first layer, fill the pan to approximately one-third of the depth. Use a spatula to distribute the aggregate to avoid segregation. Raise the pan 1 in., and drop it to a solid surface. Repeat the drop three more times. For the second layer, fill the pan to approximately two-thirds of the depth. Use a spatula to distribute the aggregate evenly. Raise the pan 1 in., and drop it to a solid surface. Repeat the drop three more times. For the third layer, completely fill the pan until the aggregate is slightly above the top rim of the pan. Place the straightedge firmly across the rim and, using a sawing motion, strike off the surface of the sample so that it is flush with the rim. Fill gaps between the straightedge and the sample with fine aggregate such that the surface is level. Raise and drop the pan four times as specified for the first two layers. Otherwise, do not compact the sample. Measure and record the weight of the sample. Obtain a sample count according to the manufacturer's instructions. Use the sample weight and count to determine if any changes in the aggregates occur during construction and establish the approximate mixture sample weights for future testing.
- 6.4. Prepare the mixture according to [KM 64-411](#), *Preparing Ingredient Materials for, and Performing, a Laboratory Mix Design of an Asphalt Mixture*. Ensure the calibration curve consists of a minimum of three points. Mix one at the target AC, one at 1% above, and one at 1% below.
- 6.5. Begin the calibration using the target AC. Place the mixture sample in a tared sample pan in three equal layers. Heat all bowls, sample pans, and tools used in the mixture-calibration process to prevent temperature loss. Fill the sample pan to approximately one-third of the pan depth. Level the mixture with a trowel or spatula. Raise the pan 1 in., and drop it to a solid surface. Repeat the drop three more times. For the second layer, fill the pan to approximately two-thirds of the depth. Use a spatula to distribute the mixture evenly. Raise the pan 1 in., and drop it to a solid surface. Repeat the drop three more times. For the third layer, completely fill the pan until the weight of the mixture in the pan equals the dry aggregate weight determined in Subsection 6.3 of this method. If the pan is not full, fill the pan to the point that the mixture is mounded slightly above the top rim of the pan. Measure and record the weight of the mixture in the pan. Use this weight (± 10 g) for all calibrations and test samples using this mixture calibration. Level the top of the mixture using a trowel or spatula. Raise and drop the pan four times as specified for the first two layers. Place the pan of mixture on a level floor, and place the compaction plate on top of the pan. Stand on the plate to consolidate the sample. Compact all samples at a minimum temperature of 240 °F to ensure that the mix will compact properly. In order to obtain uniform compaction for each calibration sample, ensure the compaction temperature of each sample is within ± 10 °F of one another.
- NOTE 2: Use a target compaction temperature of 265 °F.
- 6.6. Place the sample of mixture in the NACG, and proceed per the manufacturer's instructions for operation of the equipment and the sequence of operation. Count all calibration samples on the 16-min. calibration count.

- 6.7. Repeat Subsections 6.5 and 6.6 of this method for the remaining calibration samples. Use the same weight as obtained in Subsection 6.5 of this method for all calibration samples.

NOTE 3: Retain the midpoint/target AC pan after the NACG calibration as a check sample for NACG accuracy. Seal the pan in a plastic bag to prevent the accumulation of moisture.

- 6.8. Prepare a calibration curve by plotting the calibration sample reading versus AC on linear graph paper, choosing a convenient scale factor for the counts and AC. Connect the points with a straight line. Ensure the calibration has a correlation factor greater than or equal to 0.995 (1.000 is a perfect correlation). Calculate the correlation factor using the following formula:

$$\text{Correlation Factor} = \sqrt{1 - \frac{\sum_i (Y_i - \hat{Y}_i)^2}{\sum_i (Y_i - \bar{Y})^2}},$$

where:

Y_i = actual AC values for each sample (%);

\hat{Y}_i = calculated AC values from the curve;

\bar{Y} = mean of the actual AC values (%); and

i = number of calibration samples.

- 6.9. Perform the calibration procedure for each asphalt mixture. Although the aggregate combination remains constant, when introducing any solid additive or modifier into the mixture, perform a separate calibration. However, when using 0.5% or less liquid anti-stripping additive, do not perform a separate calibration.

NOTE 4: Use this calibration procedure with recycled-asphalt pavement (RAP) incorporated into the mixture, provided the RAP is of uniform gradation, AC, and asphalt binder grade. When using RAP, mix it in the calibration samples at the same rate used in the overall mixture.

7. PREPARATION OF TEST SAMPLE:

- 7.1. Place the test sample in the sample pan by the same method used in the preparation of the mixture-calibration samples. Also, ensure the test sample is the same weight (± 10 g) as the calibration samples. Use the same compaction temperature ± 10 °F.
- 7.2. Determine the moisture content of the mixture according to [KM 64-434](#). Subtract the percentage of moisture from the NACG reading for each test sample. Alternatively, dry the test sample to a constant mass in an oven at 230 ± 9 °F, thereby eliminating the need for a moisture-content determination. Exercise caution when drying test samples in an oven. Do not dry the test sample in an oven for longer than two hours prior to testing it in the NACG. If a constant weight cannot be achieved within the two-hour time period,

determine the moisture content of the mixture by KM 64-434.

8. PROCEDURE:

- 8.1. Obtain a sample of the plant-produced mixture according to [KM 64-425](#). Prepare the test samples for AC determination as described in [Subsection 6.5](#) of this method.
- 8.2. Place the test sample in the NACG, and proceed as described in the manufacturer's instructions to obtain the sample counts. Count all test samples on four- or 16-min. counts. Determine the NACG reading, and adjust the value by subtracting the moisture content obtained as described in [Subsection 7.2](#) of this method.

9. STANDARDIZATION:

- 9.1. All nuclear devices are subject to long-term aging of the radioactive source, detectors, and other electronic systems; this aging may change the relationship between the count rate and AC. Therefore, develop new calibration curves periodically, at a minimum of once yearly. Changes in the surroundings of the NACG may also produce changes in the count rate. In order to minimize these effects, perform background counts daily, and keep the NACG away from potential influences that may affect the count as described in [Subsection 3.2](#) of this method.

NOTE 5: When using the equipment either continuously or intermittently during the day, leave the power on to prevent having to repeat background counts. This practice will provide more stable and consistent readings.

- 9.2. Dry-aggregate standard count.
 - 9.2.1. Turn on the equipment, and allow for the stabilization of the equipment according to the manufacturer's recommendations.
 - 9.2.2. Prepare the dry aggregate sample as described in [Subsections 6.2 and 6.3](#) of this method. Ensure the sample weight is the same as measured in the calibration procedure in [Subsection 6.3](#) of this method.
 - 9.2.3. Place the dry aggregate sample in the NACG, and proceed as per the manufacturer's instructions for operation of the equipment and the sequence of operation. Compare the dry aggregate count against the "calibration of the dry aggregate" reading to determine if any changes in the aggregate have occurred. Changes in the aggregate may affect both the aggregate and mixture sample counts. Perform a new calibration if a change in the dry aggregate count of $\pm 1.0\%$ occurs.

10. CALCULATIONS AND REPORT:

- 10.1. Retain a record of each calibration sample for each mixture on file. Include the date of the calibration testing, NACG model and serial number, mixture type and calibration identification number, aggregate sources and sizes, percent of each aggregate, gradation of the mixture, asphalt binder type and source, AC, and total sample weight. Also include the

background count, dry aggregate count, and calibration constants for each mixture sample.

- 10.2. Supply the calibration record for each mixture to the Cabinet.
- 10.3. For acceptance testing, supply the printed record of each test with the appropriate *Asphalt Mixtures Acceptance Workbook (AMAW)*. Supply a continuous tape or connected series of tickets documenting all of the tests for a given day's production. When using the NACG to obtain test results from other mixtures (commercial sales, other mixtures, projects, etc.), include the record of all such testing. Clearly note and mark those records that are not applicable to the mixture in question. Include the calibration data for the mixture and the data for each acceptance test in each subplot's acceptance information. Specifically, provide the following data:

NACG model and serial number
Date and the time tested
Producer identification (SiteManager number)

Project identification (project code number)
Sample identification (consecutive numbering of the tests during production)

Sample weight
Background count
Identification number of the current mixture's calibration
Count time (duration of the testing)
AC results and the sample counts
Mixture identification (SiteManager material code)
Calibration constants (three samples)

- 10.4. Determine the AC of each test sample as displayed by the NACG. As specified in [Subsection 7.2](#) of this method, subtract the moisture content of the mixture from the NACG reading.
- 10.5. Calculate the actual AC by the following formula:

$$AC (\%) = W_1 - W_2,$$

where:

W_1 = NACG reading; and

W_2 = percent of moisture in the mixture.

- 10.6. Report the AC results to the nearest 0.1 percent on the AMAW.

APPROVED



DIRECTOR
DIVISION OF MATERIALS

DATE

02/21/08

Kentucky Method 64-437-08
Revised 02/21/08
Supersedes KM 64-437-03
Dated 01/15/03

ASPHALT BINDER CONTENT DETERMINATION OF ASPHALT MIXTURES
BASED ON THE MAXIMUM SPECIFIC GRAVITY

1. SCOPE:
 - 1.1. This method describes the procedures for calculating the asphalt binder content (AC) of an asphalt mixture based on the maximum specific gravity (G_{mm}) of that mixture.
 - 1.2. Much of the terminology and many of the formulas presented in this method are from portions of *Mix Design Methods for Asphalt Concrete and Other Hot-Mix Types*, Manual Series No. 2 (MS - 2), Sixth Edition, and *Superpave Mix Design*, Superpave Series No. 2 (SP - 2), 1996 Printing, from the Asphalt Institute.
2. SIGNIFICANCE AND USE: This method is one of a group of approved means of determining the AC of asphalt mixtures. Other means include [Kentucky Method \(KM\) 64-405](#), *Extraction of Binder From Asphalt Paving Mixtures*; [KM 64-436](#), *Asphalt Binder Content Determination of Asphalt Mixtures by Plant Recordation*; [KM 64-437](#), *Asphalt Binder Content Determination of Asphalt Mixtures by the Nuclear Asphalt Content Gauge (NACG)*; or AASHTO T 308, *Determining the Asphalt Binder Content of Hot-Mix Asphalt (HMA) by the Ignition Method*. Use [KM 64-438](#) for acceptance, process-control, or informational testing.

NOTE 1: The suitability of this method is directly dependent upon the *uniformity*, specifically the specific gravity and absorption, of the given aggregate. When the characteristics of the aggregate are significantly variable, do not use this means of AC determination for acceptance purposes.

3. PROCEDURE:
 - 3.1. At the end of the “set-up” period, furnish the Department with two G_{mm} samples. Make these samples from “hand-mixed,” not plant-mixed, material. Ensure the samples represent the mixture for the project. Batch the sample: (1) by proportioning the hot-bin material from batch plants; (2) by proportioning the stockpile or cold-feed materials (for all types of plants); (3) by obtaining a composite belt-cut sample after the aggregates have passed over the scalping screen; or (4) from plant-run aggregates. Batch the sample to the actual gradation and AC at which the mixture is reported as acceptable (either from the original mix design report or a revised report issued after the “set-up” period). Ensure each “hand-mixed” sample conforms to the minimum sample sizes in AASHTO T 209, *Theoretical Maximum Specific Gravity and Density of Bituminous Paving Mixtures*.
 - 3.2. After receiving the aforementioned two samples, the Department will determine

the G_{mm} of each sample according to T 209. The average of these tests, provided the values are reasonably similar (within ± 0.015 of each other), will then be the target G_{mm} . If the two individual G_{mm} values do not compare within this tolerance, the next step in the effort to establish a target G_{mm} will be at the discretion of the Department. Some possible actions include a request to the Superpave Plant Technologist (SPT) for additional samples, comparison to G_{mm} analyses performed on plant-produced mixture, or reference to earlier laboratory or field verification data from a similar mixture.

- 3.3. Using these values for G_{mm} (obtained from the samples produced by the SPT and tested by the Department) and AC (obtained from the original or revised mix design report), calculate an effective specific gravity of the aggregate, that will remain constant, using the following formula:

$$G_{se} = \frac{P_{mm} - AC}{\frac{P_{mm}}{G_{mm}} - \frac{AC}{G_b}},$$

where: G_{se} = effective specific gravity of the aggregate;
 P_{mm} = total loose mixture, percent by total weight of the mixture = 100;
 AC = asphalt content, percent by total weight of the mixture;
 G_{mm} = maximum specific gravity of the mixture; and
 G_b = specific gravity of the asphalt (normally 1.03).

- 3.4. After defining the G_{se} , use the results of the subplot's G_{mm} samples to calculate that particular subplot's AC by using the following formula:

$$AC = \frac{100 \left(\frac{G_{se}}{G_{mm}} - 1 \right)}{\frac{G_{se}}{G_b} - 1}.$$

- 3.5. Unless the test sample is completely free of moisture, determine the moisture content according to [KM 64-434, Determination of Moisture Content in Asphalt Mixtures \(Rapid Field Test\)](#), and make a correction to the calculated AC to compensate for the moisture.
- 3.6. The G_{se} will remain constant for the particular mixture and production period. Any change in the aggregates composing the mixture may result in a change in that mixture's G_{mm} value, which in turn will change the G_{se} constant. Therefore, when an appreciable change in the aggregate (e. g., different gradation, specific gravity/absorption, etc.) occurs, repeat the process outlined in Subsections 3.1 through 3.3 of this method, and define a new G_{se} constant.

4. EXAMPLE:

- 4.1. For example, after the “set-up” period, two G_{mm} samples, produced by the SPT and analyzed by the Department, yield 2.489 and 2.485, with an average of 2.487. The AC

specified in the mix design report is 5.0 %. Using these two values, calculate the G_{se} as follows:

$$G_{se} = \frac{\frac{P_{mm} - AC}{P_{mm}}}{\frac{G_{mm} - G_b}{G_b}} = \frac{\frac{100 - 5.0}{100}}{\frac{2.487 - 1.03}{1.03}} = 2.687.$$

- 4.2. Next, to represent a given subplot of material, obtain two G_{mm} samples to determine the AC. The average of the samples is 2.491. Determine the AC of the subplot as follows:

$$AC = \frac{\frac{100(\frac{G_{se}}{G_{mm}} - 1)}{G_{se} - 1}}{\frac{100(\frac{2.687}{2.491} - 1)}{2.687 - 1}} = \frac{100(\frac{2.687}{2.491} - 1)}{\frac{2.687}{1.03} - 1} = 4.9\%.$$

- 4.3. Finally, correct the calculated AC for moisture as described in [Subsection 3.5](#) of this method.
- 4.4. Refer to the [worksheet attached](#) to this method for calculating the AC based on the G_{mm} .
- 4.5. When supplied with the proper information (the results of the “hand-mixed” G_{mm} samples and the AC at which those samples were produced), the [Asphalt Mixtures Acceptance Workbook \(AMAW\)](#) will automatically calculate the AC of each subplot based on the G_{mm} results from the volumetric analysis for that subplot.

APPROVED

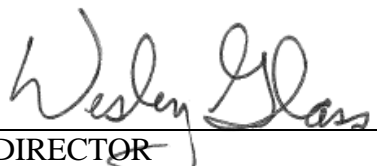

 DIRECTOR
 DIVISION OF MATERIALS

DATE

02/21/08

Kentucky Method 64-438-08
 Revised 02/21/08
 Supersedes KM 64-438-03
 Dated 01/15/03

Attachment

**WORKSHEET FOR
AC DETERMINATION OF ASPHALT MIXTURES BASED ON G_{mm}
(to be used in conjunction with KM 64-438)**

County: _____ Date: _____

Project Number: _____

Contractor: _____ Location: _____

Sampled by: _____ Tested by: _____

1. Target G_{mm} : _____ (*from "hand-mixed" samples*)
2. AC (%): _____ (*from original or revised report*)
3. Target G_{se} :

$$G_{se} = \frac{100 - AC}{\frac{100}{G_{mm}} - 1.03}$$

Target G_{se} = _____ as calculated from the formula above.

4. AC determination from subplot's G_{mm} samples:

$$AC(\%) = \frac{100 \left(\frac{G_{se}}{G_{mm}} - 1 \right)}{\frac{G_{se}}{1.03} - 1}$$

G_{se} is determined in Step 3.

Sample Number	G_{mm}	AC (%)

SAMPLING ASPHALT MIXTURES FROM THE PAVING SITE

1. SCOPE - This method establishes the procedure for sampling asphalt mixtures from the paving site for insoluble residue samples and other testing or evaluation.

NOTE 1: Sampling is as important as testing; take every precaution to obtain a representative sample.

2. APPARATUS AND MATERIALS -

- 2.1. Provide a square-ended shovel, at least 5 in. wide.
- 2.2. Provide a large pan or sample container.
- 2.3. Provide a suitable surface for "breaking up" the asphalt mixture.
- 2.4. Provide joint paving ("brown") paper.
- 2.5. Provide a plastic bag.
- 2.6. Provide a marker (for identification).

3. SAMPLING LOCATION - Obtain samples from the paver hopper at the paving site. However, the Department reserves the right, when unusual circumstances arise or when the results of testing indicate the need for further testing, to sample at any point.

4. SAMPLING PROCEDURE-

- 4.1. Allow the truck to completely unload before obtaining the sample. Stop the paver with a full hopper of mixture. In order to adequately represent the material, obtain sample portions from three locations across the width of the paver hopper as displayed in the sketch on p. 3. Obtain sufficient portions to provide a sample of approximately 7500 g (no less than 5000 nor greater than 10,000 g).
- 4.2. Before obtaining the sample, inspect the mixture in the hopper for uniformity. If there are significant variations in the grading of the mix (if segregation is apparent) across the width of the hopper (or front to back in the hopper), address this condition prior to obtaining a sample. When the mixture within the paver is reasonably uniform, take the sample.
- 4.3. Obtain each portion by digging into and removing approximately the top 12 in. of the mixture. Then, insert the shovel at an angle, and remove the sample. Take care to obtain portions that are representative of the gradation of the mixture. Place each portion into a large pan or sample container, and identify it as specified in Section 6 of this method.

5. SAMPLE PREPARATION WHEN SAMPLING FOR INSOLUBLE RESIDUE -

NOTE 2: Preparation of the sample in the manner specified in Subsection 5.1 of this method is optional. Each District will establish how much on-site preparation is practical.

5.1. Lay the joint paving (“brown”) paper on a flat surface, such as the bed of a pickup truck, and dump the pan of mix on the paper. Ensure the size of the piece of paper is large enough so that the mix can be flattened to an inch or less in thickness. Allow the mix to cool. Work the mix by hand, breaking it apart until it separates into individual coated particles, to the extent practical. Take care not to lose any mix and thus bias the sample.

5.2. After the sample has cooled, fold the paper so as not to lose any of the mix, and place the sample in a plastic bag.

6. SAMPLE IDENTIFICATION - On a sample tag, record the county, project number, truck number, time the sample was obtained, type of mixture, and name of the person who obtained the sample. Attach the sample identification to the sample, and distribute it to the appropriate party for testing. In the case of insoluble residue samples, submit the sample to the District Materials Engineer.

APPROVED

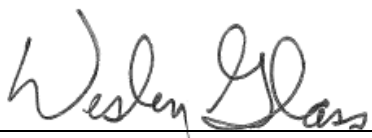

DIRECTOR
DIVISION OF MATERIALS

DATE

02/21/08

Kentucky Method 64-439-08

Revised 02/21/08

Supersedes KM 64-439-02

Dated 12/13/01

METHOD FOR CORING AND DETERMINING PERCENT OF SOLID DENSITY
OF IN-PLACE, COMPACTED, ASPHALT MIXTURE COURSES

1. SCOPE: This method documents the procedure for obtaining, storing, and transporting density cores extracted from asphalt pavement. This method also covers separating the uppermost layer of in-place, compacted, asphalt mixture from full- or partial-depth cores and determining the percent of solid density of that layer for the determination of pay values.
2. APPARATUS:
 - 2.1. Coring equipment: Provide a truck or portable core-drill rig with a masonry bit capable of obtaining a core with a minimum diameter of approximately 4 in. and a depth that allows the core to be removed without affecting the density of the asphalt mixture course to be measured.
 - 2.2. Provide a masonry saw capable of separating the asphalt core across its diameter without fracturing, cracking, or otherwise affecting the density of the asphalt mixture course to be measured.
 - 2.3. The Department will provide a fan capable of producing airflow sufficient to dry the cores in a timely manner.
 - 2.4. Provide scales and a suspension apparatus conforming to AASHTO T 166, *Bulk Specific Gravity of Compacted Hot Mix Asphalt (HMA) Using Saturated Surface-Dry Specimens*.
 - 2.5. Provide a water bath, conforming to T 166, of a suitable size for immersing cores and capable of maintaining a temperature of $77 \pm 1.8^{\circ}\text{F}$.
3. CORE SAMPLING:
 - 3.1. Frequency: As specified in Subsection 402.03.02 of the Department's *Standard Specifications for Road and Bridge Construction*.
 - 3.2. Location: As determined by [Kentucky Method \(KM\) 64-113](#), *Sampling Materials by Random Number Sampling*.
 - 3.3. Size: Entire thickness of the uppermost course placed, not less than approximately 4 in. and not more than approximately 6 in. in diameter.
4. PROCEDURE:
 - 4.1. After completing the entire compaction process and allowing the mat to cool sufficiently to permit the removal of the core without damaging it, core at locations determined by the Engineer according to Subsection 3.2 of this method. Under inspection by the Engineer, core to a depth that allows the course designated for testing to be removed from the core hole without affecting the density of that course.

- 4.2. After removing the core, label it in such a manner that all cores may be identified for each subplot within each lot. As an example, in the second lot, second subplot, label the first core obtained as "2-2-A." Further, in the third lot, fourth subplot, label the third core obtained as "3-4-C." Label joint density cores obtained from surface courses in like manner. As an example, in the second lot, second subplot, label the first joint core obtained as "2-2-J1." Further, in the third lot, fourth subplot, label the second joint core obtained as "3-4-J2."
- 4.3. If, during the process of removing the core from the roadway, the course to be tested is damaged, move approximately 6 in. forward (in the direction of the paving operation), and take another core for density determination.
- 4.4. Promptly fill each core hole with compacted asphalt mixture or non-shrink grout before the next lift of asphalt pavement is placed.
- 4.5. Once the core has been removed from the compacted pavement, determine the lift thickness to be separated. If this thickness can't be determined, measure to the planned thickness, and mark a line on the core. Separate the core by sawing it at the determined thickness, taking care to remove all material other than the uppermost course. Perform this operation at the coring site. Do not apply excessive pressure and possibly damage the core. Remove any fines, mud, dust, etc., on the core that may have been generated by the coring or sawing process.
- 4.6. Retain the uppermost course that was placed for testing; discard all other material. Immediately provide the retained portion of the density core to the Engineer at the coring site.
- 4.7. The Engineer will transport the density cores to the Section Supervisor's office or District Materials laboratory with the utmost care. The Engineer will ensure that the cores are not transported or stored at elevated temperatures or in direct sunlight (e.g., in the cab of a vehicle without ventilation, in the bed of a truck, etc.). The Engineer will also secure the cores during transport so that damage (e.g., the loss of material) does not occur.

NOTE 1: Density cores should not be stored or transported on an uneven surface. Cores should be placed flat on the cut face or stood on end in order to avoid damage.

- 4.8. The Engineer will expose the cores to airflow from a fan until they reach a constant mass (normally overnight, but a minimum of 8 h). The cores should be arranged in a single layer such that all exposed surfaces receive constant and uniform airflow in order to expedite the drying process.
- 4.9. The Engineer will test the retained portion according to T 166.

5. CALCULATION:

- 5.1. Calculate the bulk specific gravity (G_{mb}) of the core according to T 166.

- 5.2. Determine the percent of solid density of the core from a given subplot using the following formula:

$$\text{Percent of Solid Density} = 100 \left(\frac{G_{mb} \text{ of core}}{G_{mm} \text{ of subplot}} \right),$$

where:

G_{mb} of core = the bulk specific gravity of the core; and
 G_{mm} of subplot = the theoretical maximum specific gravity of the plant-produced mixture for that subplot.

6. REPORT:

- 6.1. Report all “percent of solid density” results to the nearest 0.1 percent.
- 6.2. Report all results on the applicable *Asphalt Mixtures Acceptance Workbook (AMAW)*.
- 6.3. The Department will report the core density results to the Contractor no later than working days after, but preferably within one working day of, receiving the cores.
two

APPROVED



DIRECTOR
DIVISION OF MATERIALS

DATE

04/14/09

Kentucky Method 64-442-09
Revised 04/14/09
Supersedes KM 64-442-08
Dated 03/04/08

METHOD FOR VERIFYING A CONTRACTOR'S LABORATORY MIX DESIGN

1. SCOPE:

1.1. This method is intended for use by Kentucky Transportation Cabinet (Cabinet) personnel, both District and Division of Materials (Division), in verifying a contractor's laboratory mix design, hereinafter referred to as the "contractor's design." This laboratory mix design may have been produced by the contractor's own personnel or by a commercial laboratory. The verification process involves comparing values from the contractor's design to results from the Cabinet, either the District or the Division, hereinafter referred to as the "evaluating authority."

1.1.1. In the case of District personnel, the comparison involves the testing of AADTT Class 2 mixtures. The District will compare the values from the contractor's design to the District's results from the gyratory specimens and maximum-specific-gravity (G_{mm}) samples produced by the contractor.

1.1.2. In the case of Division personnel, the comparison involves the testing of AADTT Class 3 and 4 mixtures, Stone-Matrix Asphalt (SMA), Sand Asphalt (Type I or II), Sand Seal Surface, or any specialty mixtures as defined in Kentucky Method (KM) 64-421. The Division will compare the values from the contractor's design to the Division's results from the gyratory specimens and G_{mm} samples produced by the contractor and/or to the results from the Division's design [normally a one-point check at the contractor's declared optimum asphalt binder content (AC)].

1.2. If the comparison between the contractor's design and the applicable Cabinet testing satisfies the given tolerances, then the Cabinet will consider the contractor's design acceptable for use. If the same comparison fails to satisfy the given tolerances, further investigation will be necessary. To this end, this method offers possible investigative steps to pursue.

2. REFERENCED AND RELATED STANDARDS: The equipment required to complete the verification described in this method is found in a number of other methods. Also, this method references several other methods and standards. These standards include the following:

2.1. Kentucky Methods:

[KM 64-411](#), *Preparing Ingredient Materials for, and Performing, a Laboratory Mix Design of an Asphalt Mixture*

[KM 64-421](#), *Establishing the Job-Mix Formula of Asphalt Mixtures by the Contractor*

[KM 64-435](#), *Method for Acceptance of Asphalt Mixtures by Mixture Property Analysis*

[KM 64-605](#), *Specific Gravity and Absorption of Fine Aggregate*

2.2. AASHTO Standards:

M 323, *Superpave Volumetric Mix Design*

R 35, *Superpave Volumetric Design for Hot Mix Asphalt (HMA)*

T 85, *Specific Gravity and Absorption of Coarse Aggregate*

T 176, *Plastic Fines in Graded Aggregates and Soils by Use of the Sand Equivalent Test* T 304, *Uncompacted Void Content of Fine Aggregate*

T 324 *Hamburg Wheel-Track Testing of Compacted Asphalt Mixtures*

2.3. ASTM Standards:

D 4791, *Flat Particles, Elongated Particles, or Flat and Elongated Particles in Coarse Aggregate*

D 4867, *Effect of Moisture on Asphalt Concrete Paving Mixtures*

D 5821, *Determining the Percentage of Fractured Particles in Coarse Aggregate*

3. PROCEDURE:

3.1. Verifying the Contractor's Design for AADTT Class 2 Mixtures:

3.1.1. As required by [KM 64-421](#), the contractor must submit two gyratory specimens and two G_{mm} samples, along with the laboratory design performed according to R 35, to the evaluating authority (normally the District). The evaluating authority tests these specimens and G_{mm} samples and compares the results to those corresponding values from the contractor's design.

3.1.2. The evaluating authority will compare the bulk specific gravity (G_{mb}) value at the contractor's declared optimum AC to the average G_{mb} result from the evaluating authority's tests. Likewise, the evaluating authority will compare the G_{mm} value at the contractor's declared optimum AC to the average G_{mm} result from the evaluating authority's tests.

3.1.3. The results from the specimens and G_{mm} samples tested by the evaluating authority must compare to those values from the contractor's design within the following tolerances in order to successfully "verify" the contractor's design. These tolerances are similar to those values given in [KM 64-435](#).

G_{mb} : ± 0.024

G_{mm} : ± 0.015

Air Voids (%): ± 1.2

VMA (%): ± 1.5

- 3.1.4. If the evaluating authority successfully verifies the contractor's design, the evaluating authority will report the mixture as acceptable at the contractor's declared optimum AC using the mixture values from the contractor's design. The evaluating authority may adjust the recommended AC if extensive justification (such as experience with similar mixtures, extreme traffic or loading conditions, etc.) is available. If the evaluating authority does not successfully verify the contractor's design, the evaluating authority will follow the procedure outlined in the following subsection of this method.
- 3.1.5. If the evaluating authority does not successfully verify the contractor's design, the evaluating authority will perform further investigation to determine the cause of the discrepancy. Specifically, the evaluating authority will follow the guidelines given in Subsection 113.07 of the Cabinet's *Standard Specifications for Road and Bridge Construction* (Specifications) in an attempt to determine the cause of the discrepancy. The evaluating authority will decide which items to investigate. The difference in values will occur in the G_{mb} value, the G_{mm} value, or both.
- 3.2. Verifying the Contractor's Design for AADTT Class 3 or 4 Mixtures, SMA, Sand Asphalt (Type I or II), Sand Seal Surface, or Any Specialty Mixtures
- 3.2.1. As required by [KM 64-421](#), the contractor must submit a laboratory design; samples of aggregate, asphalt binder, and liquid anti-stripping additive (if used); and two gyratory specimens and two G_{mm} samples to the evaluating authority. The evaluating authority (normally the Division) may choose to verify the contractor's design in one of two ways. The evaluating authority may choose to only test the two gyratory specimens and two G_{mm} samples submitted by the contractor. In this case, the procedure described in [Subsection 3.1](#) of this method applies. Otherwise, the evaluating authority may choose to test the two gyratory specimens and two G_{mm} samples submitted by the contractor and to perform a laboratory mix design (normally a one-point check at the contractor's declared optimum AC) on the mixture in question. In this case, both the procedures described in Subsection 3.1 of this method (for contractor-submitted specimens and samples) and in the following subsections of this method (for the laboratory mix design performed by the evaluating authority) apply.
- 3.2.2. Aggregate Properties:
- 3.2.2.1. Specific Gravity:
- 3.2.2.1.1. The evaluating authority will perform specific gravity testing on all component aggregates in the mixture, according to [KM 64-605](#) and T 85, and compare these results to the values reported in the contractor's design. If the specific gravity result of a given aggregate component compares to the value reported in the contractor's design within ± 0.03 ,
KM 64-443-22

then the evaluating authority will use the value reported in the contractor's design in all successive calculations. If the specific gravity result of a given aggregate component does not compare to the value reported in the contractor's design within ± 0.03 , then the evaluating authority will follow the procedures outlined in the following subsection of this method.

3.2.2.1.2. The evaluating authority will perform specific gravity testing on another portion of the component aggregate in question. If the average of this retested result and the original result still does not compare to the value reported in the contractor's design within ± 0.03 , then the evaluating authority will perform a review of the historical specific gravity data for that particular source and size. If the average of the retested result and the original result compares adequately, in the opinion of the evaluating authority, to the historical data, then the evaluating authority will use the average of the retested result and the original result in all successive calculations. If not, the evaluating authority will conduct an in-depth investigation of the discrepancies on a case-by-case basis. This investigation may involve obtaining and testing another sample of the component aggregate in question to determine if the specific gravity of the source has changed. The evaluating authority may also require comparison testing with the contractor.

3.2.2.2. Consensus Properties:

3.2.2.2.1. The evaluating authority will perform aggregate testing to determine the Superpave consensus properties for the mixture: coarse-aggregate angularity according to D 5821; flat-and-elongated particles according to D 4791 (for SMA only); fine-aggregate angularity according to T 304 (Method A); and sand equivalency according to T 176. These results must compare to those values from the contractor's design within the following tolerances in order to successfully "verify" the contractor's design.

Coarse-Aggregate Angularity (%): ± 10 for both one-or-more and two-or-more crushed faces

Flat-and-Elongated (%): ± 5
(for SMA only)

Fine-Aggregate Angularity (%): ± 2

Sand Equivalent (%): ± 15

- 3.2.2.2.2. If the evaluating authority’s result of a given aggregate consensus property compares to the value reported in the contractor’s design within the tolerance given in the preceding subsection of this method, then the evaluating authority will use the value reported in the contractor’s design in the judgment of the mixture’s acceptability. If a given aggregate consensus property does not compare to the value reported in the contractor’s design within the tolerance given in the preceding subsection of this method, then the evaluating authority will follow the procedures outlined in the following subsections of this method.
- 3.2.2.2.3. The evaluating authority will perform aggregate testing on another portion of aggregate for the consensus property in question. If the average of this retested result and the original result compares to the value reported in the contractor’s design within the tolerance given in Subsection 3.2.2.2.1 of this method, then the evaluating authority will use the value reported in the contractor’s design in the judgment of the mixture’s acceptability. If the average of this retested result and the original result still does not compare to the value reported in the contractor’s design within the tolerance given in Subsection 3.2.2.2.1 of this method, then the evaluating authority will use the average of the retested result and the original result in the judgment of the mixture’s acceptability.

3.2.3. Mixture Volumetrics:

- 3.2.3.1. The evaluating authority will compare the average G_{mb} value at the contractor’s declared optimum AC point from the contractor’s design to the corresponding G_{mb} result from the evaluating authority’s design (one-point check). Likewise, the evaluating authority will compare the G_{mm} value at the contractor’s declared optimum AC point from the contractor’s design to the corresponding G_{mm} result from the evaluating authority’s design (one-point check).
- 3.2.3.2. The results from the evaluating authority’s design must compare to those values from the contractor’s design within the following tolerances in order to successfully “verify” the contractor’s design. These tolerances are similar to those values given in [KM 64-435](#).

G_{mb} : ± 0.024

G_{mm} : ± 0.015

Air Voids (%): ± 1.2

VMA (%): ± 1.5

- 3.2.3.3. If the evaluating authority successfully verifies the contractor's design, the evaluating authority will report the mixture as acceptable at the contractor's declared optimum AC, using the mixture values from the contractor's design. The evaluating authority may adjust the recommended AC if extensive justification (such as experience with similar mixtures, extreme traffic or loading conditions, etc.) is available. If the evaluating authority does not successfully verify the contractor's design, the evaluating authority will follow the procedure outlined in the following subsections of this method.
- 3.2.3.4. If the evaluating authority does not successfully verify the contractor's design, the evaluating authority will perform further investigation to determine the cause of the discrepancy. The following items are possibilities to investigate in an attempt to determine the cause of the discrepancy. The evaluating authority will decide which items to investigate. The difference in values will occur in the G_{mb} value, the G_{mm} value, or both.
 - 3.2.3.4.1. The evaluating authority may elect to investigate some or all of the items offered in Subsection 113.07 of the [Specifications](#).
 - 3.2.3.4.2. In addition, the evaluating authority may elect to repeat some or all of the laboratory design (one-point check), including the "weigh-up," mixing, compacting, and testing of the mixture. Also, depending on the source of the discrepancy, the evaluating authority may investigate only the G_{mb} or the G_{mm} .
 - 3.2.3.4.3. At the conclusion of the investigation, the evaluating authority will resolve the difference(s) between the values from the contractor's design and the results from the evaluating authority's design (one-point check) according to Subsection 113.07 of the Specifications.

3.2.4. Tensile Strength Retained (TSR):

- 3.2.4.1. The contractor must report a value for the TSR of the mixture, performed according to D 4867, as a part of the laboratory design submitted to the evaluating authority. The evaluating authority may also perform TSR testing on the mixture as part of the verification of the contractor's laboratory design and compare the result to the TSR value from the contractor's design.
- 3.2.4.2. The TSR result from the evaluating authority's design must compare to the value from the contractor's design within ± 20 percent in order to successfully "verify" the contractor's design. If the TSR result from the evaluating authority's design compares to the value reported in the contractor's design within ± 20 percent,

then the evaluating authority will use the value reported in the contractor's design in the judgment of the mixture's acceptability. If the TSR result from the evaluating authority does not compare to the value reported in the contractor's design within ± 20 percent, then the evaluating authority will follow the procedures outlined in the following subsections of this method.

3.2.4.3. If the evaluating authority does not successfully verify the contractor's design, the evaluating authority will perform further investigation to determine the cause of the discrepancy. The following items are possibilities to investigate in an attempt to determine the cause of the discrepancy. The evaluating authority will decide which items to investigate.

3.2.4.3.1. The evaluating authority may elect to investigate some or all of the items offered in Subsection 113.07 of the [Specifications](#).

3.2.4.3.2. In addition, the evaluating authority may elect to repeat some or all of the TSR test, including the "weigh-up," mixing, compacting, and testing of the mixture. The evaluating authority may elect to repeat the TSR test on specimens without anti-stripping additive, with anti-stripping additive, or both.

3.2.4.3.3. At the conclusion of the investigation, the evaluating authority will resolve the difference(s) between the values from the contractor's design and the results from the evaluating authority's design according to Subsection 113.07 of the Specifications.

3.2.5. Mixture Performance:

3.2.5.1. The contractor must report a value for the rutting resistance of the mixture in accordance with AASHTO T 324. The average passes to failure at a critical rut depth of 1/2" or 12.5 mm shall be indicated on the mix design and verified by the department. Minimum requirements are set forth by subsection 403.03.03 of the Specification.

3.2.5.2. The contractor must demonstrate adequate cracking resistance of AADTT Class 2 & 3 mixtures. For Class 4, the Department will fabricate six specimens in accordance with KM 450 and the mixture must meet an average CTIndex of 110 to "verify" successfully.

—

4. MIXTURE VERIFICATION:

4.1. The purpose of this method is the verification of the contractor's design by the evaluating

authority. This verification process involves several separate steps, including volumetrics, aggregate, and TSR testing. It is entirely possible that the evaluating authority may successfully verify some aspects of the contractor's mixture design and not successfully verify other portions. In turn, it is also possible that in the report of the mixture's acceptability, some values may be from the contractor's design, and some results may be from the evaluating authority's tests.

- 4.2. It is not the responsibility of the evaluating authority to necessarily approve the mixture, but rather to verify the mixture's properties in order to establish its quality at the laboratory stage. If the evaluating authority verifies the mixture at the laboratory stage, it is then probable that the mixture will provide an adequate "starting point" for future plant production.
- 4.3. It is also not necessary that the results from the evaluating authority's tests satisfy the applicable mixture criteria; the purpose of this verification process is only to ensure that the evaluating authority's evaluation satisfies the aforementioned tolerances. Additionally, a case may arise in which the result from the evaluating authority's test does not fall within the specified tolerance of the result from the contractor's test, but the result from the evaluating authority's test does satisfy the applicable specification. In this case, the evaluating authority may deem that property to be acceptable despite the unsuccessful verification with the contractor's design.
- 4.4. After verifying each aspect of the contractor's design, or otherwise determining that its result is the more correct value to report, then the evaluating authority will report the mixture's acceptability on the most current version of the "[Asphalt-Mixture-Design-Results Form](#)." This form is an Excel spreadsheet distributed by the Division, commonly known as "MixPack." Depending on the success of the evaluating authority's verification, the values reported on the spreadsheet may be from the contractor's design, the evaluating authority's tests, or some combination of both.
- 4.5. If the evaluating authority does not verify some or all of the mixture properties, and the evaluating authority determines that its result(s) is the more correct value(s) to report, and this result(s) fails to satisfy the applicable criteria, then the evaluating authority will not report the mixture as acceptable at the laboratory stage. In this case, the contractor must make appropriate adjustments and submit another design to the evaluating authority for verification.

APPROVED

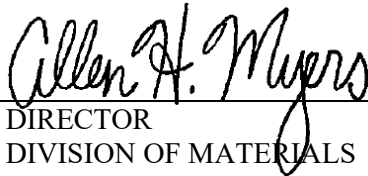

DIRECTOR
DIVISION OF MATERIALS

DATE

05/26/22

Kentucky Method 64-443-22
Revised 05/26/22
Supersedes KM 64-443-09
Dated 04/01/09

Kentucky Method 64-444-17
Dated 05/17/17
Supersedes KM 64-444-06
Dated 5/10/06

KENTUCKY TRANSPORTATION CABINET (KYTC)
APPROVED SUPPLIER CERTIFICATION (ASC)
PROGRAM FOR PERFORMANCE-GRADED
(PG) ASPHALT BINDERS

1. SCOPE:

- 1.1 According to the Department's *Standard Specifications for Road and Bridge Construction*, Section 806, PG asphalt binders may only be furnished by asphalt terminals included on the KYTC ASC program. The KYTC ASC program permits the manufacture and shipment of PG binders within the framework of a quality-control plan (QCP) without complete pretesting of the PG binder by the Department's Division of Materials (DOM). This ASC program follows the requirements outlined in AASHTO R26, *Standard Practice for Certifying Suppliers of Performance-Graded Asphalt Binders* with modifications as found in this Kentucky Method (KM).
- 1.2 Three conditions are excluded from this plan: 1) storage of PG binders in a dedicated tank for use at a single contractor's hot-mix asphalt (HMA) plant; 2) any change in binder grade due to the addition of recycled asphalt pavement; and 3) the addition of silicone or anti-strip additives.
- 1.3 Terminal and contractor qualification: All terminals that: 1) supply multiple HMA facilities; or 2) make/modify PG binders are required to comply with the guidelines of the ASC program. If PG binders are manufactured at a contractor's HMA plant, then the Department will require these materials to comply with the guidelines of the ASC program.
- 1.4 ASC approval will be specific for the supplier/terminal and will not be transferable to other sites.
- 1.5 PG binders will conform to Section 806. Binders not covered by those specifications will be tested and approved by the DOM on an individual basis. In these cases, the supplier will maintain responsibility for full AASHTO M320, *Standard Specification for Performance-Graded Asphalt Binder*, AASHTO T350, *Standard Method of Test for Multiple Stress Creep Recovery (MSCR) Test of Asphalt Binder Using a Dynamic Shear Rheometer (DSR)*, and any other testing deemed necessary by the Department. Testing frequency will also be determined by the DOM.

2. QUALIFICATION:

2.1 Laboratory/testing requirements:

- 2.1.1 All terminals must perform testing as required by Subsection 2.3.4 of this KM.

- 2.1.2 All binder laboratories that provide certification test results must be AASHTO re:source accredited and participate in the AASHTO re:source proficiency-sample program. Ratings of three or better on all AASHTO M320 properties and any other necessary tests (+ testing) are required. If a pattern of low ratings is noted by the DOM, the laboratory will be unable to provide test data for supplier certification. Forward copies of the AASHTO re:source proficiency results to the DOM within one month of receipt. Satellite laboratories at terminals may be inspected by the primary laboratory that meets the above requirements. Forward satellite inspection documentation to the DOM within two weeks of the inspection.
- 2.2 QCP:
- 2.2.1 If any changes that affect the QCP occur, the supplier shall notify the DOM immediately and subsequently update the QCP to reflect these changes.
- 2.2.2 If any discrepancies arise between the terminal's QCP and this KM, this KM will apply.
- 2.3 Quality Control Testing:
- 2.3.1 The DOM will require AASHTO M320(+) testing, including modifications found in Section 806, to be performed on all PG binders.
- 2.3.2. A supplier will be qualified to ship a specific PG binder after a minimum of three production batches are tested by the DOM and full compliance with AASHTO M320(+) specifications is verified for each sample. If no new batch is manufactured within one week of taking the first sample, the existing batch may be re-tested. Do not sample the batch closer than one week apart. If two separate batches are produced within the same week, sample the batch, and submit it for testing provided documentation of the new production is attached. Acceptable documentation would be AASTHO M320(+) data from the new material added to the tank.
- 2.3.3. While a supplier is in the process of having the three production batches tested, the Department will allow material to be shipped from the batch(es) in question if it has been tested and approved by the DOM. In this case, the DOM will supply a batch number for the material.
- 2.3.4. In addition to AASHTO R26, perform an original DSR check for the upper PG temperature for each storage tank when certified material is added, to verify that the resulting blend is still in compliance. If no additional material is added, perform this quality-control test at a minimum of once per week per tank. Perform this test on the first working day of each week. All terminals must have a DSR onsite to perform this testing, or be able to obtain an original DSR result from an AASHTO re:source accredited laboratory within two hours of sampling to test. When materials from different sources are blended to produce a new material, certify the resulting blend by complete AASHTO M320(+) testing. When any uncertified material is blended with a certified material, complete full AASHTO M320(+) testing.

If a terminal's DSR malfunctions, a terminal may obtain a DSR result from an accredited laboratory on a temporary basis. Contact the DOM and ensure the DSR is repaired in a timely manner.

- 2.3.5 When certified material is pumped directly from a rail car or barge into a transport truck, obtain a sample of the material from the rail car or barge, and perform the DSR quality-control check as required in Subsection 2.3.4. Forward the DSR test results and the AASHTO M320(+) test results supplied by the manufacturer to the DOM on the appropriate form, referencing the terminal's batch number.
- 2.3.6 The Department will not require compliance testing for winter months when production ceases. For suppliers continuing on the ASC program, furnish a complete set of AASHTO M320(+) test data and one sample of material for each grade produced to the DOM when shipping resumes. If the test data and sample are not received by the DOM within two weeks of the resumption of shipping, the supplier shall be removed from the ASC program and will be ineligible to ship material to Department projects.

3. DOCUMENTATION:

- 3.1 Quality control tests: Submit a summary of all AASHTO M320(+) and DSR tests to the DOM a minimum of every two months. Maintain detailed records of all quality-control tests, inspections, and shipments for at least two years.
- 3.2 Material Certification:
 - 3.2.1 Tank certification: Submit a completed KYTC Materials form, TC 64-439, to the DOM with the appropriate AASHTO M320(+) test results and a batch number. Submit this form every 30 days, when new, certified material is added to a tank, or when AASHTO M320(+) testing is performed. The batch number will contain the terminal designation, tank number and date. The terminal designation is a three letter ID determined by the DOM. The tank number can be a three number, letter, or number/letter combination assigned by the terminal. The date is when a sample was last taken for certification testing (not the date the material was introduced into the tank). This date will usually be the date sampled by the manufacturer prior to shipment to the terminal. For example the batch number XXX11A010117 is a binder from terminal XXX, taken from tank 11A, that was sampled for testing on January 1, 2017. Material certification expires after 30 days from the sample date.
 - 3.2.1.1 When certified material is added to a tank already containing certified material, submit a TC 64-439 form to the DOM. The form should contain complete AASHTO M320(+) test data furnished by the supplier for the new material, and the required original DSR results performed at the terminal (see subsection 2.3.4). List DSR results under "REMARKS." The entire tank will be recertified under the new batch number and the quantity should accurately reflect the quantity in the tank.

3.2.1.2 When the material's certification has expired, new AASHTO M320(+) testing must occur in order to recertify the tank. Submit test data with the new batch number to the DOM.

3.2.1.3 When certified material is mixed with uncertified material, new AASHTO M320(+) testing must occur in order to certify the tank. Submit test data with the new batch number to the DOM.

3.2.2 Certification of In-line Blends: For each material that is manufactured by rack blending directly into a tank or railcar, complete AASHTO M320(+) testing will occur a minimum of once per week. In addition, an original DSR check will be performed at least once per day to ensure blend consistency. Only materials blended utilizing a calibrated electronic metering system will be accepted. An acceptable system will be recognized by inclusion on an approved list for in-line blending. The quantity of the material will be recorded on the KYTC form as "INLINE".

3.3 Bill-of-lading: In addition to the requirements of AASHTO R26, Subsection 11.3, also include the following four items: the batch number; the project number/destination for the material if known; an indication if silicone, anti-strip additive, or similar material has been incorporated into the binder; and the signature (electronic acceptable) of the producer's representative.

4. QUALITY ASSURANCE SAMPLING AND TESTING: Furnish split samples obtained at random, as directed by the DOM, from the supplier's terminal. Ensure that the PG binder samples are representative of the material being shipped from that particular location. Submit two quarts of PG binder to the DOM for each split sample. AASHTO M320(+) test results from the supplier must follow within ten days of sampling the material. DOM representatives may visit any of the supplier's facilities for the purpose of obtaining split samples and/or observation of sample collection and quality-control testing.

5. NON-COMPLIANT MATERIALS:

5.1 Notification of non-compliance: If any information is obtained by the supplier that indicates a quantity of PG binder is not in compliance with the specification(s): 1) notify the DOM immediately, by telephone and in writing, of the PG binder in question; 2) identify the material by batch number; and 3) cease shipment/use of the material. A full AASHTO M320(+) analysis of the material in question indicating full compliance is required before shipping may resume. Notify the DOM before resuming shipment.

5.2 Probation and removal from the ASC program: The Department will consider unsatisfactory material to be production batches of a particular PG binder, tested either through split samples or field samples, that are not in compliance with the specification(s). One unsatisfactory batch will place a supplier on probation. Two out of three unsatisfactory batches will constitute removal from the ASC program for that particular PG binder. The DOM will investigate the cause of non-compliance. If the non-compliance is found to be terminal-related, only the terminal will be restricted from shipping instead of the supplier.

5.3 Reinstatement: If a supplier is removed from the ASC program, reinstatement will be contingent upon three consecutive production batches being tested by the DOM and meeting the compliance specifications.

6. CONTINUED APPROVAL: Continued approval under the ASC program will be contingent upon a record of satisfactory performance as determined by the DOM and documented by inclusion on the Department's [List of Approved Materials](#).

APPROVED

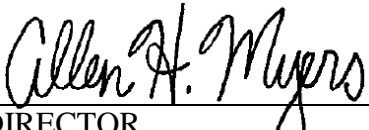

DIRECTOR
DIVISION OF MATERIALS

DATE

05/17/17

Kentucky Method 64-444-17

Dated 05/17/17

Supersedes KM 64-444-06

Dated 05/10/06

Kentucky Method 64-445-17
Dated 05/30/17
Supersedes KM 64-445-05
Dated 12/28/04

KENTUCKY TRANSPORTATION CABINET (KYTC) EMULSIFIED ASPHALTS SUPPLIER
CERTIFICATION (EASC) PROGRAM

1. SCOPE:

- 1.1. According to the Department's *Standard Specifications for Road and Bridge Construction*, Section 806, emulsified asphalts may only be furnished by suppliers included in the KYTC EASC program. The KYTC EASC program permits the manufacture and shipment of emulsified asphalts within the framework of a quality-control plan (QCP) without complete pretesting of the emulsified asphalt by the Department's Division of Materials (DOM). This EASC program follows the requirements outlined in AASHTO R77, *Standard Practice for Certifying Suppliers of Emulsified Asphalt*, with modifications as found in this Kentucky Method (KM).
- 1.2. Supplier qualification: All suppliers that: 1) create or substantially change the properties of an emulsified asphalt or 2) supply material to multiple contractors are required to comply with the guidelines of the EASC program.
- 1.3. EASC approval will be specific for the supplier/terminal and will not be transferable to other sites.
- 1.4. For specialty applications, other emulsified asphalts specified for use on Department projects will be tested and approved by the DOM. Maintain responsibility for full compliance testing at a frequency to be determined by the DOM.

2. QUALIFICATION:

- 2.1. All facilities that provide certification test results must be AASHTO re:source accredited and participate in the AASHTO re:source proficiency-sample program. Ratings of three or better on all AASHTO T59, *Testing Emulsified Asphalts*, properties are required. If a pattern of low ratings is noted by the DOM, the laboratory will be unable to provide test data for material certification. Forward copies of the AASHTO re:source proficiency results to the DOM within one month of receipt. Satellite laboratories at terminals may be inspected by a primary laboratory that meets the above requirements.
- 2.2. QCP:
 - 2.2.1. If any changes that affect the QCP occur, the supplier shall notify the DOM immediately, and subsequently update the QCP to reflect these changes.
 - 2.2.2. The minimum testing frequency for emulsions is one complete AASHTO T59 analysis, including the modifications found in Section 806, every 30 days, when new material produced, or when uncertified material and certified materials are mixed.

2.3. Quality-Control Testing:

- 2.3.1. Perform the minimum quality-control tests according to the Department's *Standard Specifications*, Section 806, for each type of emulsified asphalt included in the attached table.
- 2.3.2. A supplier will be qualified to ship a specific emulsified asphalt after a minimum of three production batches are tested by the DOM and full compliance with test specifications is indicated for each sample. If no new batch is manufactured within one week of taking the first sample, the existing batch may be re-tested. Do not sample these production batches closer than one week apart. If two separate production batches are produced within the same week, sample these batches, and submit them for testing provided documentation of the new production is attached.
- 2.3.3. While a supplier is in the process of having the three production batches tested, the Department will allow material to be shipped from the batch(es) in question if it has been tested and approved by the DOM. In this case, the DOM will supply a batch number for the material.
- 2.3.4. The Department will not require compliance testing for winter months when production ceases. For suppliers continuing on the EASC program, furnish a complete set of compliance test data and one sample of material for each type of emulsified asphalt produced to the DOM when shipping resumes. If the test data and sample are not received by the DOM within two weeks of the resumption of shipping, the supplier shall be removed from the EASC program and will be ineligible to ship material to Department projects.

3. DOCUMENTATION:

- 3.1 Quality control tests: Submit a summary for all quality-control tests performed to the DOM every two months. Maintain detailed records of all quality-control tests, inspections, and shipments for at least two years.
- 3.2 Material Certification:
 - 3.2.1 Tank certification: Submit a completed KYTC Materials form, TC 64-439, to the DOM with the appropriate AASHTO T59 test results and a batch number. Submit this form every 30 days, when new, certified material is added to the tank, or when AASHTO T59 testing is performed. The batch number will contain the terminal designation, tank number, and date. The terminal designation is a three letter ID determined by the DOM. The tank number can be a three number, letter, or number/letter combination assigned by the terminal. The date is when a sample was last taken for certification testing (not the date the material was introduced into the tank). This date will usually be the date sampled by the manufacturer prior to shipment to the terminal. For example the batch number XXX11A010117 is an emulsion from terminal XXX, taken from tank 11A, that was sampled for testing on January 1, 2017. Material certification expires after 30 days from the sample date.

- 3.2.1.1 When certified material is added to a tank already containing certified material, submit a TC 64-439 form to the DOM. The form should contain complete AASHTO T59 test data furnished by the supplier for the new material. The entire tank will be recertified under the new batch number and the quantity should accurately reflect the quantity in the tank.
- 3.2.1.2 When the material's certification has expired, new AASHTO T59 testing must occur in order to certify the tank. Submit test data with the new batch number to the DOM.
- 3.2.1.3 When certified material is mixed with uncertified material, new AASHTO T59 testing must occur in order to certify the tank. Submit test data with the new batch number to the DOM.

3.2.2 Certification of In-line Blends: For each material that is manufactured by rack blending directly into a tanker or railcar, complete AASHTO T59 testing will occur a minimum of once per week. Only materials blended utilizing a calibrated electronic metering system will be accepted. An acceptable system will be recognized by inclusion on an approved list for inline terminal blending. The quantity of the material will be recorded on the KYTC for as "INLINE".

3.3. Bills-of-lading: In addition to the requirements of AASHTO R77, Subsection 11.3, also include the following three items: the batch number; the project number/destination of the material if known; and the signature (electronic acceptable) of the producer's representative.

4. QUALITY ASSURANCE SAMPLING AND TESTING: Furnish split samples obtained at random, as directed by the DOM, from the supplier's terminal. Ensure that the emulsified asphalt samples are representative of the material being shipped from that particular location. Submit two gallons of emulsified asphalt to the DOM for each split sample. All appropriate test results, as required by Section 806, must follow from the supplier within five working days of sampling the material. DOM representatives may visit any of the supplier's facilities for the purpose of obtaining split samples and/or observation of sample collection and quality-control testing.

5. NON-COMPLIANT MATERIALS:

5.1. Notification of non-compliance: If any information is obtained by the supplier that indicates a quantity of emulsified asphalt is not in compliance with the specification(s): 1) notify the DOM immediately, by telephone and in writing, of the emulsified asphalt in question; 2) identify the material by batch number; and 3) cease shipment/use of the material. A full analysis of the material in question, as required by Section 806, indicating full compliance is required before shipping may resume. Notify the DOM before resuming shipment.

5.2. Probation and removal from the KYTC EASC program: The Department will consider unsatisfactory material to be production batches of a particular emulsified asphalt, tested either through split samples or field samples, that are not in compliance with the specification(s). Two unsatisfactory batches will place a supplier on probation. Two out of three unsatisfactory production batches will constitute removal from the EASC program

for that emulsified asphalt. The DOM will investigate the cause of non-compliance. If the non-compliance is found to be terminal-related, only the terminal will be restricted from shipping instead of the supplier.

5.3. Reinstatement: If a supplier is removed from the EASC program, reinstatement will be contingent upon three consecutive production batches being tested by the DOM and meeting the compliance specifications.

6. CONTINUED APPROVAL - Continued approval under the EASC program will be contingent upon a record of satisfactory performance as determined by the DOM and documented by inclusion on the Department's [List of Approved Materials](#).

APPROVED

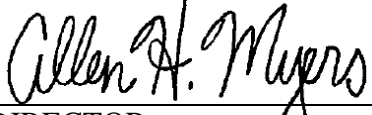

DIRECTOR
DIVISION OF MATERIALS

DATE

05/30/17

Kentucky Method 64-445-17

Dated 05/30/17

Supersedes KM 64-445-05

Dated 12/28/04

Attachment

QUALITY-CONTROL TESTS FOR EMULSIFIED ASPHALTS

Tests	SS-1h	SS-1	CSS-1h	RS-2	CQS-1hP	AE-200	HFMS-2	HFRS-2	CRS-2P	KP-6
Viscosity @ 77 °F	X	X	X		X	X				
Viscosity @ 122 °F				X			X	X	X	
Residue by Distillation	X	X	X	X	X	X	X	X	X	
Oil Distillates						X				
Demulsibility				X				X	X	
Residue Penetration	X	X	X	X	X		X	X	X	
Particle Charge			X		X				X	
Float Test, s						X	X	X		
Coating Test						X				
Sieve	X	X	X	X	X		X	X	X	
Asphalt Residue, 680 °F										X
Water Content										X
Storage Stability	X	X	X	X		X	X	X	X	
Ductility, cm	X	X	X	X			X	X		X
Ash Content, % ⁽¹⁾	X	X	X	X		X	X	X	X	X
Softening Point										
Elastic Recovery, %					X					
Flash Point, °F					X				X	X

The minimum testing frequency, as required by Section 806, is every 30 days or when new material is produced, and at least once when the asphalt source changes.

⁽¹⁾Test required once a year, or when new asphalt source is used.

CHEMICAL INTERACTION TESTS FOR TRAFFIC LOOP ENCAPSULANT

1. SCOPE: These tests were designed to measure the effect of various chemicals on traffic loop encapsulant.
2. APPARATUS -
 - 2.1. Provide rectangular plates, and templates that conform to ASTM C 679, *Standard Test Method for Tack-Free Time of Elastomeric Sealants*.
 - 2.2. Provide a spatula, capable of striking off the sample surface to a uniform thickness.
 - 2.3. Provide a glass beaker large enough to hold traffic loop sample and enough of the selected chemical to cover the sample.
3. SAMPLE: Ensure the test samples are of a uniform thickness.
4. PROCEDURE -
 - 4.1. Condition and prepare the five test samples according to 8.2-8.3 of ASTM C 679, *Standard Test Method for Tack-Free Time of Elastomeric Sealants*. Let samples cure for seven days.
 - 4.2. Immerse one traffic loop encapsulant sample in each of the following: motor oil (20W50), deicing chemicals (5% CaCl and NaCl solutions), gasoline, and hydraulic brake fluid (DOT 3).
 - 4.3. Allow samples to remain immersed for 24 hours.
 - 4.4. Record any changes in the traffic loop encapsulant.

5. REPORT: Results of these tests will be reported pass/fail. For a passing result, no effect should result from immersion in motor oil, deicing chemicals, or hydraulic brake fluid. The gasoline sample is allowed a slight swell.

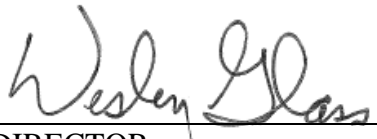
APPROVED 

DIRECTOR
DIVISION OF MATERIALS

DATE 02/21/08

Kentucky Method 64-446-08
Revised 02/21/08
Supersedes KM 64-446-03
Dated 11/21/03

Kentucky Method 64-447-08
Revised 02/21/08
Supersedes KM 64-447-03
Dated 11/21/03

CURE TEST FOR TRAFFIC LOOP ENCAPSULANT

1. SCOPE: This test was designed to measure the time needed for a complete cure of a 1/8" thick sample.
2. APPARATUS -
 - 2.1. Provide rectangular plates, and templates that conform to ASTM C 679, *Standard Test Method for Tack-Free Time of Elastomeric Sealants*.
 - 2.2. Provide a spatula, capable of striking off the sample surface to a uniform thickness.
 - 2.3. Provide a sharp blade capable of making a clean cut through the cured material.
3. SAMPLE: Ensure a test sample of a uniform thickness.
4. PROCEDURE -
 - 4.1. Condition and prepare the test sample according to 8.2-8.3 of ASTM C 679, *Standard Test Method for Tack-Free Time of Elastomeric Sealants*
 - 4.2. Test sample for complete dry time at the 30 hour point by cutting a cross section through the material with a sharp blade.
5. REPORT: Assign sample exhibiting no uncured material after a 30 hour period a passing result.

APPROVED

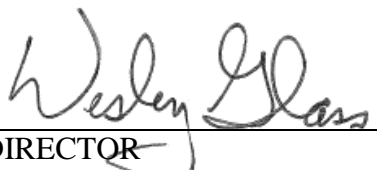

DIRECTOR
DIVISION OF MATERIALS

DATE

02/21/08

Kentucky Method 64-447-08
Revised 02/21/08
Supersedes KM 64-447-03
Dated 11/21/03

EVALUATION OF ASPHALT PAVEMENT WITH SUBSTANDARD PROPERTIES

1. SCOPE

- 1.1. The Department has developed this method in terms of a checklist for use by project personnel when evaluating asphalt pavement with substandard properties. This method is referenced in the footnotes of the Lot Pay Adjustment Schedules for Compaction Option A and B mixtures in the Department's *Standard Specifications for Road and Bridge Construction*.
- 1.2. The items noted in this document are for the consideration and benefit of project personnel in formulating a decision concerning asphalt pavement with substandard properties. Specifically, this decision will validate if it is appropriate to require removal of the pavement in question. Through the statewide use of this checklist, the Department seeks to establish a consistent approach in evaluating asphalt pavement with substandard properties.
- 1.3. This checklist provides guidance to project personnel concerning those pavement factors and characteristics most critical to satisfactory performance. Many different facets of the construction operation are discussed; it is crucially important that all applicable factors be carefully considered prior to formulating a decision regarding removal and replacement of a section of pavement.
- 1.4. Because each project and mixture is unique, probably no single factor will determine the outcome of the pavement in question. Rather, it is likely that a preponderance of evidential information and observations from various sources, coupled with sound engineering judgment, will result in the ultimate decision.

2. EVALUATION OF TEST DATA AND PAVEMENT PERFORMANCE

2.1. *Re-examination of test data*

The Asphalt Mixtures Acceptance Workbook performs the necessary calculations for acceptance and verification testing. As such, no computation errors should occur if the test results are entered correctly. However, prior to deciding to remove and replace a particular section of asphalt pavement, the raw data yielding the substandard mixture properties should be examined. All applicable data, including sample/specimen mass and aggregate specific gravity, should be evaluated for obvious errors.

2.2. *Review of process-control, verification, and independent assurance data*

2.2.1. *Process-control data*

In addition to the required acceptance testing, the contractor also performs process-control testing to ensure the quality of the asphalt mixture produced between

acceptance tests. Depending on the particular timing and frequency, some process-control tests may fall near an acceptance test whose results revealed substandard mixture properties. In these cases, the results from the process-control test should be compared to the results from the acceptance test. While it is true that materials or plant operations may change between process-control and acceptance tests, resulting in different mixture properties, the examination of process-control data may prove valuable in validating questionable property values.

2.2.2. *Verification data*

According to the Department's *Standard Specifications*, Department personnel are required to verify the contractor's acceptance test at a frequency of one subplot per lot. In the case where the substandard mixture properties from a given acceptance test fall in the particular subplot that the Department verifies, the results from the verification test should validate the questionable values. Depending on whether or not the same testing equipment was utilized, the similarity in results between the contractor's acceptance test and the Department's verification test will vary. However, provided the results compare within the tolerances from the Department's *Standard Specifications*, any substandard mixture properties from the acceptance test should be considered valid.

2.2.3. *Independent assurance data*

For particular projects on the National Highway System, using a dedicated sample for this purpose, Department personnel are required to compare results obtained with the sampling procedure and testing equipment used for the contractor's acceptance test. It is further required that Department personnel utilize different testing equipment than that used when testing for acceptance. Depending on the sample selected for the comparison, some independent assurance tests may compare directly with, or fall near, an acceptance test whose results revealed substandard mixture properties. In these cases, the results from the independent assurance test should be compared to the results from the acceptance test. In most circumstances, the testing equipment will differ between the independent assurance test and the comparison test. However, for the sake of validating the questionable acceptance results, this comparison may prove helpful. Provided the results from the acceptance test and the independent assurance test are similar, comparing within the tolerances from the Department's *Standard Specifications*, any substandard mixture properties from the acceptance test should be considered valid.

2.3. *Review of test data and pavement performance for previous lots of production*

2.3.1. While it is true that ingredient materials or plant operations may change between sublots of production, resulting in different mixture properties, the examination of test data or pavement performance for previously produced mixtures may prove useful in validating questionable property values. However, when performing such a comparison, it is extremely important to evaluate the component materials to ensure that the two mixtures, the previously produced material and the material with substandard properties under evaluation, are comprised of essentially the same ingredients and proportions.

2.3.2. When the similarity between the previously produced material and the material with substandard properties has been verified, obvious errors in test results should become apparent. For example, if adjoining sections of pavement with similar levels of air voids (AV) are performing in a significantly different manner, then one of the AV test results from the two periods of production is likely incorrect. General instructions on reviews such as these are very difficult; performing such comparisons requires considerable experience and should be performed on a case-by-case basis. Familiarity with a particular aggregate, mixture, or mixing plant is invaluable in these instances.

3. REVIEW AND OBSERVATION OF TESTING PERSONNEL

3.1. The practices of the individual responsible for the performance of the test and documentation of the data that resulted in the substandard mixture properties may be observed. Although any Superpave Plant Technologist or Superpave Mix Design Technologist is considered qualified to perform the process-control, acceptance, or verification testing that identified the questionable material, an informal review of the procedures employed by the involved technologists may reveal an important deviation.

3.2. Also, as part of a continuing evaluation, it is often beneficial to routinely review the practices of all testing personnel to ensure that the proper sampling and testing techniques are utilized. The purpose of this exercise is to verify the continued competency of the involved technologists and thereby eliminate all doubt in this regard.

4. RE-EXAMINATION OF RETAINED MIXTURE SAMPLES

4.1. *Loose asphalt mixture (G_{mm} samples)*

Prior to deciding to remove and replace a particular section of asphalt pavement, all available mixture samples from the affected production should be analyzed. These samples include the loose asphalt mixture obtained for theoretical maximum specific gravity (G_{mm}) determination. As required by the Department's *Standard Specifications*, the contractor must retain these samples for five working days. The G_{mm} of an asphalt mixture is a very important property. This value influences asphalt binder content (AC) when "back-calculation from the G_{mm} " is selected as the method for AC determination. The G_{mm} value also affects the AV and determines the target "solid density" for the roadway cores. It is critically important that the correct G_{mm} value be identified before deciding to remove and replace any pavement.

4.2. *Superpave gyratory compactor (SGC) specimens*

As stated previously, it is absolutely necessary that all available mixture samples from the applicable period of asphalt mixture production be scrutinized prior to removing and replacing any questionable asphalt pavement. In addition to the G_{mm} samples, the contractor is required to retain the SGC specimens from all acceptance tests for five working days. The bulk specific gravity (G_{mb}), determined from these SGC specimens, affects both the AV and voids-in-the mineral aggregate (VMA). As with the G_{mm} determination, it is equally important that the correct G_{mb} value be identified before deciding to remove and replace any asphalt pavement.

4.3. *Pavement density cores*

The masses of the original pavement cores utilized in the density determination should be closely inspected. While it is not apparent when a minor error has occurred in the G_{mb} determination, obvious mistakes in the core evaluation process should be easily identified. Such mistakes may involve recorded masses that are clearly not practicable. As an approximation, it is also possible to determine the mass of the original density cores again. Because it is very difficult to dry the previously tested core back to its original mass, this practice is not appropriate to precisely determine density. However, as a “rough check,” this procedure should identify obvious errors in the recorded masses.

5. CONSIDERATION OF THE POSITION OF THE MIXTURE WITHIN THE PAVEMENT STRUCTURE

5.1. *Surface*

5.1.1. The most critical mixture in any pavement structure is the surface course. This mixture directly supports the traffic loading, provides the necessary level of skid resistance, and endures the environmental conditions. Therefore, the highest standard of quality must be applied to the surface course. For asphalt mixtures with high AC or in-place density or low AV or VMA, rutting/shoving and flushing/bleeding are serious concerns in the surface mixture. Surface pavements with substantial rutting in the wheelpaths are potentially hazardous due to hydroplaning during heavy rains. Also, surface pavements with extended segments of flushing/bleeding present an increased skidding potential. For asphalt mixtures with low AC or in-place density or high AV or VMA, raveling and stripping are concerns in the surface mixture. Segregation is a major issue as well in the surface course.

5.1.2. For these reasons, asphalt surface mixtures with substandard properties should strongly be considered for removal and replacement. Specific conditions that could develop into a major pavement distress or failure are exacerbated more severely in the surface course than in any other mixture within the pavement structure. In some instances, depending on the particular pavement distress, a fine-textured seal course over the affected area is an option to consider. However, in general, the highest possible standard should be applied when considering surface mixtures. Removing and replacing substandard asphalt surface mixtures may prevent numerous problems in the underlying layers for years to come.

5.2. *Upper base course (top 4 in. of pavement structure)*

5.2.1. Although not as crucial as the surface mixture, upper base courses within the top four inches of the surface are very important as well. These layers provide the strength that ultimately supports the traffic loading and are critical to the drainage characteristics of the overall pavement structure. Larger nominal-maximum sizes of asphalt base mixture are typically permeable and experience significant levels of moisture infiltration. For base mixtures with high AC or in-place density or low AV or VMA, rutting and shoving is possible in the base layers and the surface above. For asphalt mixtures with low AC or in-place density or high AV or VMA, stripping is a

major concern due to the likely presence of moisture in the base layer. Also, segregation is a definite possibility in these asphalt base courses.

5.2.2. Therefore, asphalt base courses within the top four inches of the surface with substandard properties should be considered for removal and replacement. If the volumetric properties are grossly deficient, removal and replacement of the affected area is recommended. If the properties are marginally substandard, the base courses may be accepted in place. In the case of segregated base or low AC or in-place density, a fine-textured seal course over the affected area is an option to consider.

5.3. *Lower base course*

5.3.1. Asphalt mixtures placed as lower base courses, more than four inches from the surface, are more forgiving than the other layers previously discussed. These mixtures contribute to the strength of the matrix that supports the traffic loading; these layers also experience a significant amount of moisture infiltration as the pavement drains from upper layers. However, substandard mixture properties in lower base courses are not as likely to develop into pavement distresses. In fact, high AC or in-place density or low AV or VMA may be desirable in some cases. Higher AC and lower AV may be beneficial in lower base courses as protection from moisture damage and as a deterrent to “bottom-up” fatigue cracking. For these reasons, lower base courses comprised of asphalt mixtures with substandard properties may be allowed to remain in place in many instances.

5.3.2. Lower base courses with low AC or in-place density or high AV or VMA are more disturbing. Because these mixtures are located deep within the pavement structure, visible distresses at the pavement surface resulting from substandard mixture properties in lower base courses are less likely. On the other hand, damage resulting from moisture infiltration and saturation would be the more probable pavement failure mechanisms. Due to their “open” nature, asphalt mixtures with low AC or in-place density or high AV or VMA are more susceptible to moisture damage. In these cases, a fine-textured seal course is an option to consider for the affected locations to protect the underlying “open” mixture.

6. CONSIDERATION OF THE LOCATION OF THE PAVEMENT

6.1. *Intersection*

More stresses are applied to asphalt pavements at intersections than probably any other location of the highway. Deceleration, acceleration, turning movements, and increased temperatures due to engine heat make intersections a prime location for a number of pavement distresses. Intersections occasionally suffer from rutting, shoving, or occurrences of flushing, bleeding, or fat spots. For these reasons, asphalt pavement with questionable properties placed at, or within 500 feet of, intersections should be removed and replaced. Particularly, asphalt pavement with high AC or in-place density or low AV or VMA should be removed and replaced at or near intersections. Due to the punishing conditions, asphalt mixtures with acceptable properties at placement sometimes do not perform desirably at intersections over the expected life of the pavement. Certainly, asphalt mixtures with substandard properties cannot be expected to perform either.

6.2. *Turning lane*

Much the same as intersections, turning lanes experience severe stresses due to the nature of the traffic behavior in these areas. Rutting, shoving, or occasional occurrences of flushing, bleeding, or fat spots are possible. Due to the criticality of these locations, asphalt pavement with substandard properties placed in turning lanes should be removed and replaced. Mixture properties of particular concern in these locations include high AC or in-place density or low AV or VMA. As in intersections, asphalt mixtures with these characteristics cannot be expected to perform under such conditions.

6.3. *Truck lane*

Much the same as intersections and turning lanes, truck lanes experience severe stresses due to the nature of the traffic behavior in these areas. Typically, the traffic utilizing such locations is slow, heavily loaded vehicles. As a result, rutting, shoving, or occasional occurrences of flushing, bleeding, or fat spots are possible. Asphalt pavement with substandard properties placed in truck lanes should be removed and replaced. Mixture properties of particular concern in these locations include high AC or in-place density or low AV or VMA. As in intersections and turning lanes, asphalt mixtures with these characteristics cannot be expected to perform acceptably under such heavy loads and slow loading conditions.

6.4. *Ramp*

Much the same as intersections and turning and truck lanes, ramps also experience severe stresses due to the nature of the traffic movements in these locations. Normally on ramps, the traffic is decelerating, accelerating, or turning. The stresses generated as a result of these actions occasionally lead to rutting, shoving, or occurrences of flushing, bleeding, or fat spots. Again, asphalt pavement with questionable properties placed on ramps should be removed and replaced. Specifically, mixture properties such as high AC or in-place density or low AV or VMA in these areas are highly undesirable. As in intersections and turning and truck lanes, asphalt mixtures with these properties cannot be expected to perform for the expected life of the pavement on ramps either.

6.5. *Steep grade*

Much the same as intersections, turning lanes, truck lanes, and ramps, pavement located on steep grades also experiences severe stresses due to the traffic speed in these locations. On such grades, the traffic may be moving more slowly than in other areas. Heavily loaded trucks are especially susceptible to decreased speeds on steep grades. The stresses generated as a result of these slow-moving, heavy loads occasionally lead to rutting, shoving, or occurrences of flushing, bleeding, or fat spots. As a rule, asphalt pavement with substandard properties placed on steep grades should be removed and replaced. Specifically, mixture properties such as high AC or in-place density or low AV or VMA in these areas are highly undesirable. Asphalt mixtures with these properties cannot be expected to perform for the expected life of the pavement in such locations.

6.6. *Low-traffic facility*

- 6.6.1. Facilities that carry lower amounts or loads of traffic are certainly more forgiving than the other conditions previously discussed. Lesser traffic levels do not exacerbate potential pavement distresses as do higher amounts or loads of traffic. Asphalt mixtures with high AC or in-place density or low AV or VMA may perform adequately on low-traffic facilities. For these reasons, asphalt mixtures with marginally substandard properties may be allowed to remain in place in many instances.
- 6.6.2. Of more concern would be mixtures with low AC or in-place density or high AV or VMA. Because rutting/shoving or flushing/bleeding is less likely on these facilities, the damage resulting from environmental conditions would be the probable cause of any premature pavement failure. Due to their “open” nature, asphalt mixtures with low AC or in-place density or high AV or VMA are more susceptible to environmental damage. In these cases, a fine-textured seal course is an option to consider for the affected locations to protect the underlying “open” mixture.

6.7. *High-speed facility*

Similar to low-traffic facilities, high-speed facilities can be more forgiving than other traffic conditions. Although many of these facilities carry heavy amounts and loads of traffic, the speed of the traffic ensures that any given portion of pavement is loaded only for a small period of time. For this reason, mixture properties that could result in various pavement distresses on facilities with lower speeds may not develop into distresses on high-speed facilities. Asphalt mixtures with high AC or in-place density or low AV or VMA may perform adequately on these facilities. Therefore, asphalt mixtures with marginally questionable properties may be allowed to remain in place for many such pavements. However, this determination is difficult: even though the traffic may be categorized as “high-speed,” the amount and loading of that traffic is critical. If the pavement in question exhibits any potential distress whatsoever, strong consideration should be given to removal and replacement on high-speed facilities with heavy amounts or loading of traffic.

6.8. *“Straight-through” facility*

Facilities that carry little or no “stop and start” or turning traffic are also sometimes forgiving. As stated previously, these sorts of actions apply severe stress to the pavement structure. In turn, these forces often develop into various pavement distresses. As with high-speed facilities, pavements whose traffic is primarily steady and “straight through” may perform successfully even though the asphalt mixture that comprises the pavement exhibited substandard properties. In particular, asphalt mixtures with high AC or in-place density or low AV or VMA may perform adequately on these facilities. Therefore, asphalt mixtures with marginally substandard properties may be allowed to remain in place for these conditions. As with high-speed facilities, though, the decision is a difficult one. These “straight through” facilities may carry light, moderate, or heavy traffic. When the amount and loading of that traffic is considered moderate to heavy, serious consideration should be given to removal and replacement.

7. CONSIDERATION OF THE APPEARANCE OF THE PAVEMENT

7.1. *Flushing/bleeding/fat spots*

A relatively new pavement mat that displays locations of excessive asphalt binder such as flushing, bleeding, or a significant number of fat spots should be considered for removal and replacement. These characteristics may result from a high AC or in-place density, low AV or VMA, or an excessively fine gradation. These types of distresses are serious in nature and not easily addressed with remedial treatments. Pavements in this condition often rut, shove, and present numerous safety concerns. The best action is to remove and replace the affected area.

7.2. *Rutting/shoving*

As mentioned previously, a relatively new asphalt pavement that displays locations of rutting or shoving may suffer from a high AC or in-place density, low AV or VMA, or an excessively fine gradation. Locations of rutting or shoving often occur “hand-in-hand” with flushing and bleeding sites. Again, these types of distresses are serious in nature and present numerous safety concerns such as potential opportunities for hydroplaning and decreased skid resistance. The best action is to remove and replace the affected area.

7.3. *Segregated*

A segregated mat can result from a number of sources, from the aggregate stockpiles at the asphalt mixing plant to the paving equipment at the project site. However, considering mixture properties, low AC or in-place density, high AV or VMA, or an excessively coarse gradation may contribute to segregation. When such properties are identified through normal acceptance or verification testing and mat segregation is apparent, remedial actions are possible. If segregation is widespread over several hundred feet of continuous pavement, removal and replacement of the affected area is probably the best option. When the segregated areas are discontinuous or “spotty,” removing and replacing various areas introduces a number of new construction joints. This scenario may often be less desirable than the original, segregated mat. In these cases, a fine-textured seal course is an option to consider for the affected locations.

7.4. *Raveling*

A raveled pavement may display many of the same characteristics as a segregated mat. Accordingly, many of the same mixture properties that contribute to segregation also can lead to raveling. These properties include low AC or in-place density, high AV or VMA, or an excessively coarse gradation. In fact, raveling often occurs within a segregated mat after exposure to traffic and climate. For this reason, raveling is somewhat more serious because some amount of coated aggregate has already abandoned the pavement structure, presenting more opportunity for moisture infiltration or premature oxidation. As with segregation, if the raveling is widespread and generally continuous in nature, removal and replacement of the affected area is probably the best option. When the raveled areas are discontinuous, removing and replacing various unconnected areas introduces a number of new construction joints. This scenario may often be less desirable than the original pavement. In these cases, a fine-textured seal course is an option to consider for the affected locations.

7.5. *Inadequately coated*

A mat containing inadequately coated aggregate may exhibit many of the same characteristics as a raveled pavement. The obvious mixture property causing this phenomenon is low AC. Inadequate coating will often lead to raveling and a variety of other pavement distresses. Since the mixture in such a condition is fundamentally flawed, possible corrective actions are few. Simply sealing the affected area is not desirable; the weak plane of poorly coated material remains in the pavement structure. Removal and replacement of the affected area is normally the proper decision.

7.6. *Stripping*

Stripping normally does not occur in a new asphalt pavement. The process of stripping requires prolonged exposure to moisture and traffic. However, if some of the other distresses previously discussed were present and sufficiently severe, stripping could possibly occur early in the life of the pavement. Severe segregation, raveling, or inadequate coating could result in stripping. As with inadequate coating, stripped pavement is fundamentally flawed and significantly weaker than desirable. Sealing the affected area simply serves to “trap” the stripped layer in the structure. Again, the best action is removal and replacement of the affected area.

7.7. *Broken aggregate*

7.7.1. A new pavement mat with broken aggregate is normally a sign of overzealous compaction, improper rollers or roller patterns, or inadequate lift thickness-to-nominal maximum aggregate size ratio. However, low AC could result in a “dry” mixture that is difficult to compact. In turn, this situation could result in broken aggregate in the mat. Also, breaking aggregate while attempting to compact segregated or inadequately coated mixture is possible.

7.7.2. Even though broken aggregate is normally a construction issue, a pavement mat in this condition may experience some of the distresses discussed previously that result from substandard mixture properties. In many cases, the broken aggregate in an asphalt pavement will disintegrate, leaving “pock-marks” in the mat that present an opportunity for moisture infiltration. This condition may further deteriorate into raveling or stripping over time. As with segregation and raveling, if the broken aggregate is widespread and generally continuous in nature, removal and replacement of the affected area is probably the best option. When the areas of broken aggregate are discontinuous, removing and replacing various unconnected areas introduces a number of new construction joints. This scenario may often be less desirable than the original pavement containing the broken aggregate. In these cases, a fine-textured seal course is an option to consider for the affected locations.

APPROVED William Broyles
DIRECTOR
DIVISION OF MATERIALS

DATE 05/13/09

Kentucky Method 64-448-09
Revised 05/13/09
Supersedes KM 64-448-04
Dated 01/05/04

DETERMINING THE PERMEABILITY OF IN-PLACE HOT-MIX ASPHALT (HMA)
USING THE AIR-INDUCED PERMEAMETER (AIP)

1. SCOPE - This method describes the procedure for determining the in-place permeability of an HMA mat using the AIP. This method is applicable to all nominal-maximum aggregate sizes and gradations of HMA.
2. APPARATUS AND MATERIALS -
 - 2.1 AIP - Provide a device consisting of the following components:
 - 2.1.1 Vacuum chamber – Ensure the chamber is constructed of heavy-duty, transparent LEXAN® or its commercial equivalent and conforms to the dimensions in [Figure 1](#). Ensure that a 3.00 ± 0.25 in. sealing ring is attached to the bottom of the chamber.
 - 2.1.2 Sealing ring – Provide a silicone sealing ring conforming to the dimensions in [Figure 1](#). Ensure the vacuum chamber fits snugly in the ring opening and is tightly sealed to prevent air leakage.
 - 2.1.3 Multi-venturi vacuum cube – Provide a multi-venturi vacuum cube with an air compressor hose attachment. Ensure the cube attaches to the top of the vacuum chamber according to [Figure 1](#). In addition, ensure the cube contains a valve to restrict airflow through the cube.
 - 2.1.4 Digital gage – Provide a digital vacuum gage mounted to the top of the vacuum chamber that is capable of reading from 0 to 700 mm Hg with less than a 0.01-percent error.
 - 2.2 Air compressor - Provide an air compressor capable of delivering a constant pressure of 68 ± 3 psi.
 - 2.3 Caulking gun - Provide a caulking gun capable of extruding material from commercially available caulking tubes.
 - 2.4 Caulk - Provide a silicone-based, commercially available, rubber caulk that can be purchased in tubes.
3. PROCEDURE -
 - 3.1 Setup -
 - 3.1.1 Connect the air compressor to the multi-venturi vacuum cube.
 - 3.1.2 Check the digital gage to ensure it is operating properly and is in the “mm Hg” mode.
 - 3.1.3 Ensure all seams and orifices are in good condition.
 - 3.1.4 “Zero” the gage according to the manufacturer’s instructions. This operation needs to be performed only once per day.

3.1.5 Ensure the sealing ring is free of debris.

3.2 Sealing and placement of AIP -

3.2.1 Apply approximately a 0.5-in. bead of silicone rubber caulk approximately one inch inside the outer edge of the sealing ring.

3.2.2 Place the AIP in the center of the area to be tested, using caution not to move the AIP laterally during or after placement.

3.2.3 When placing the AIP, apply a downward force of no more than 50 lbf while twisting the AIP approximately one-eighth of a turn. It is important not to “over-twist” the device; this action may cause penetration of the silicone into the pavement voids, increasing the value recorded on the gage.

3.3 Obtaining readings -

3.3.1 Open the valve on the multi-venturi vacuum cube to permit the flow of air.

3.3.2 The reading on the digital vacuum will begin to increase. When this number reaches a peak, the test is finished, and the valve can be shut. The test time will vary depending on the permeability of the pavement, but the time should not exceed 15 s. It is important not to permit the AIP to run for an extended period of time. This practice may cause delamination or “humping” of the pavement. This point is especially important for hot, fresh-laid pavements. A “rule-of-thumb” is not to test any pavement above 130°F.

3.3.3 Record the highest reading attained by the AIP by pressing the button marked “HI/LO.” It is necessary to obtain only one reading per site.

4. CALCULATIONS AND REPORTING -

4.1 Calculate the permeability of the HMA mat in ft/day from the following equation:

$$k = 25,757.53 * V^{-1.556}$$

where: k = permeability (ft/day); and
V = vacuum reading in mm Hg.

4.2 Record the permeability to the nearest 0.1 ft/day.

APPROVED

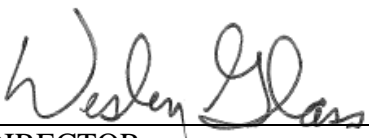

DIRECTOR
DIVISION OF MATERIALS

DATE

12/28/04

Kentucky Method 64-449-05

Dated 12/28/04

Figure 1. AIP.

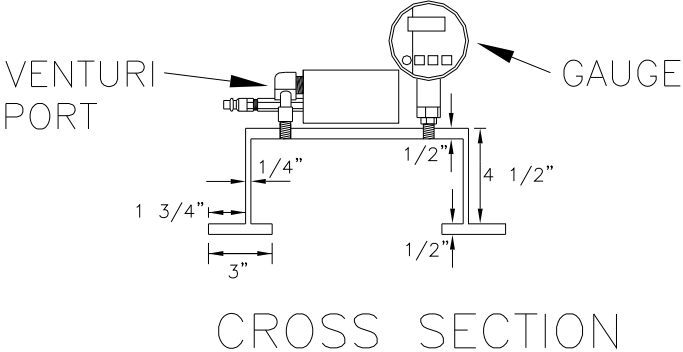
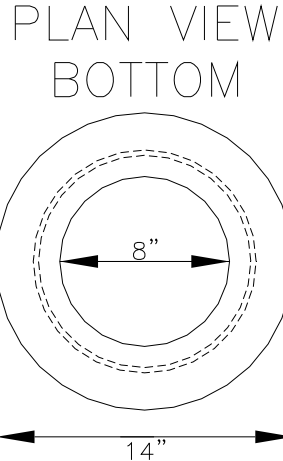
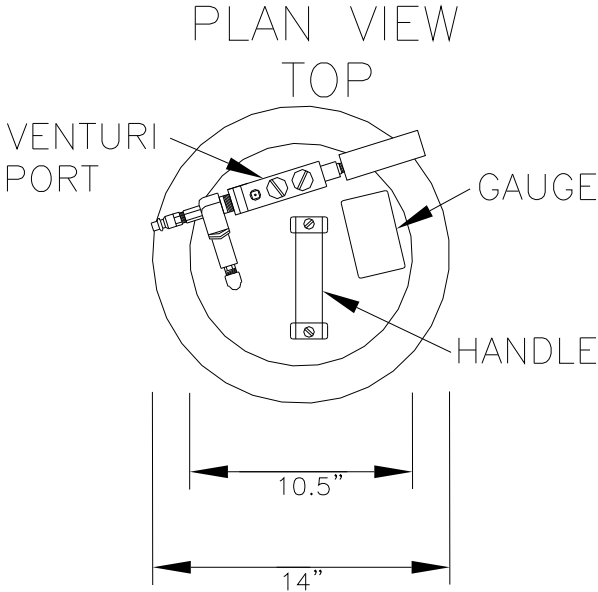

DETERMINATION OF CRACKING RESISTANCE (KYCT) OF BITUMINOUS MIXTURES

1. SCOPE:

- 1.1. This method covers the procedures for preparation, testing, and measurement of asphalt mixture cracking resistance using cylindrical laboratory prepared or pavement core asphalt mix samples. The test method describes the determination of the cracking test index $KYCT_{index}$, and other parameters determined from the load-displacement curve. These parameters can be used to evaluate the resistance of asphalt mixtures to cracking.
- 1.2. This method serves as a supplement to ASTM D8225-19, Kentucky Method KM 64-411-09, AASHTO R30, AASHTO R35, AASHTO T312, and ASTM D4867, outlining the preparation of the ingredient materials, manufacture of the asphalt mixture test specimens, and the noted deviations from the national standards. The national standards apply unless specifically noted herein.

2. TERMINOLOGY:

2.1 Definitions:

- 2.1.1 $KYCT_{index}$ - cracking test index, value used to evaluate mixture resistance to cracking.
- 2.1.2 W_f - work of fracture (Joules) calculated as the area under the load-displacement curve.
- 2.1.3 G_f - fracture energy (Joules/m²) required to induce a unit surface area of a crack and calculated as the work of fracture divided by specimen diameter (150±2 mm) and thickness (62±1mm).
- 2.1.4 P_{85} - 85 percent of the peak load (kN or lbf) at the post-peak stage.
- 2.1.5 P_{75} - 75 percent of the peak load (kN or lbf) at the post-peak stage.
- 2.1.6 P_{65} - 65 percent of the peak load (kN or lbf) at the post-peak stage.
- 2.1.7 l_{85} - displacement (mm or in.) corresponding to the 85 percent of the peak load at the post-peak stage.
- 2.1.8 l_{75} - displacement (mm or in.) corresponding to the 75 percent of the peak load at the post-peak stage.
- 2.1.9 l_{65} - displacement (mm or in.) corresponding to the 65 percent of the peak load at the post-peak stage.
- 2.1.10 m_{75} - slope (N/m or lbf/in.) calculated as $|(P_{85}-P_{65})/(l_{85}-l_{65})|$ (See Fig. 1).
- 2.1.11 $KYCT_{index}=(thickness/62) \times (G_f/m_{75}) \times (l_{75}/Diameter) \times 10^6$
NOTE: This calculation is accomplished in the KYTC CT-Test v1.02.1 software.

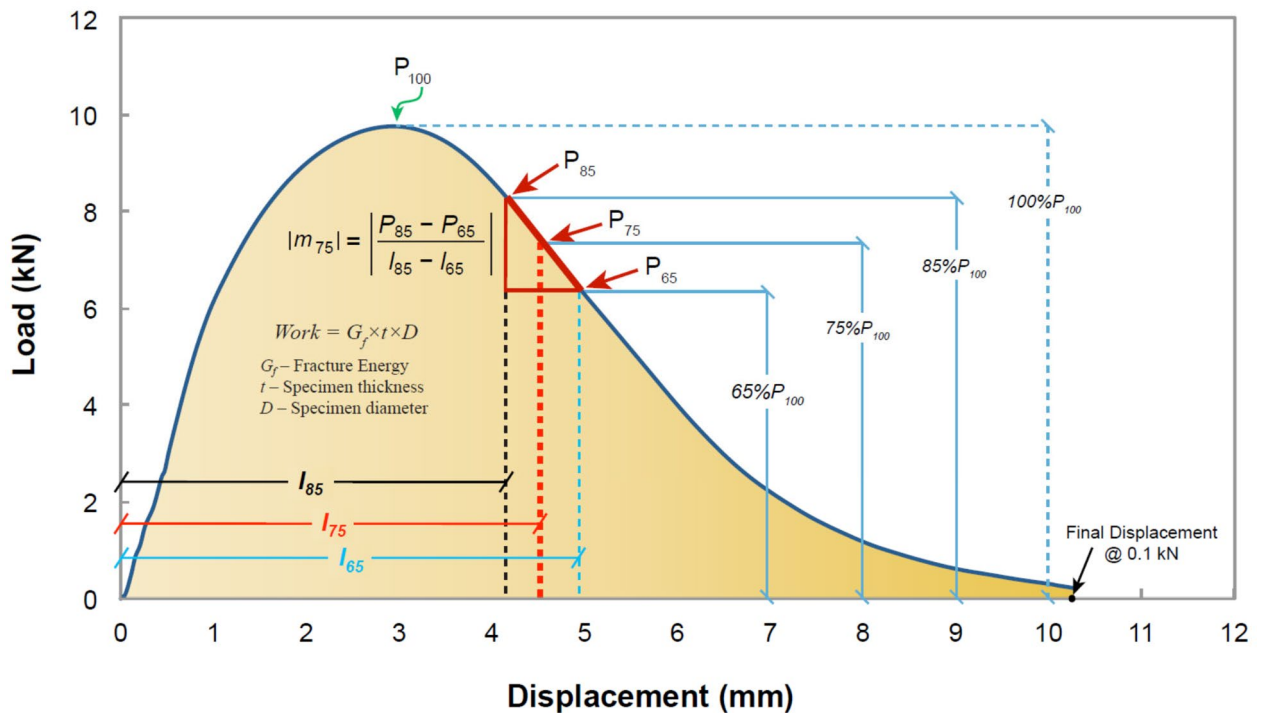

3. SUMMARY OF TEST METHOD:

3.1 A cylindrical 150 mm diameter specimen molded in a Superpave gyratory compactor (SGC) or cored from asphalt pavement is centered in the loading strips fixture. The load is applied such that a constant load-line displacement (LLD) rate of 2 in/min is obtained and maintained for the duration of the test. Both the load and LLD are measured during the entire duration of the test and are used to calculate the cracking test index (KYCT_{index}).

4. SIGNIFICANCE AND USE

4.1 The KYCT is used to determine asphalt mixture cracking resistance at an intermediate temperature. Generally, the higher the KYCT_{index} value, the better the cracking resistance. The range for an acceptable KYCT_{index} will vary according to the local environment conditions, application of mixture, traffic, and expectation of service life.

4.2 The KYCT_{index} is a performance indicator of the cracking resistance of asphalt mixtures containing various asphalt binders, asphalt binder modifiers, aggregate blends, fibers, and recycled materials so that cracking-prone mixtures are identified in the mix design stage. Determination of KYCT_{index} can be accomplished during plant production to monitor cracking susceptibility. The specimens can be readily obtained from SGC compacted specimens with a diameter of 150 mm and no cutting, gluing, notching, drilling, or instrumenting needed. Similarly, filed cores can be tested as well to measure the remaining crack resistance of in-place asphalt mixtures.

5. APPARATUS

- 5.1. Test Frame- A KYCT test frame consists of an axial loading device, a load measuring device, loading strips, specimen deformation measurement device, and a control and data acquisition system. The test frame shall be capable of maintaining a constant deformation rate of 2 in./min. An acceptable version of an electromechanical, screw driven frame is the Pine Instrument 850 Marshall Test Press with Digital Recorder.
- 5.2. Axial Loading Device-The loading apparatus shall be capable of delivering loading in compression with a resolution of 10 N(2.25 lbf) and a capacity of at least 25 kN(5,620 lbf).
- 5.3. Loading Strips mounted in a test fixture-Steel loading strips with a concave surface having a radius of curvature equal to the nominal radius of the test specimen. For specimens with a nominal diameter of 150 mm, the loading strips shall be 19.05 ± 0.3 mm wide. The length of the loading strips shall exceed the thickness of the specimen as in Fig. 2. The outer edges of the loading strips shall be beveled slightly to remove sharp edges. The loading strips shall be mounted on a base having two perpendicular guide rods or posts extending upward. The upper loading strip shall be clean and freely sliding on the posts. Guide sleeves in the upper segment of the test fixture shall direct the two loading strips together without appreciable binding or loose motion in the guide rods. The loading strip fixture utilized in accomplishing ASTM D4867 testing will satisfy this requirement.

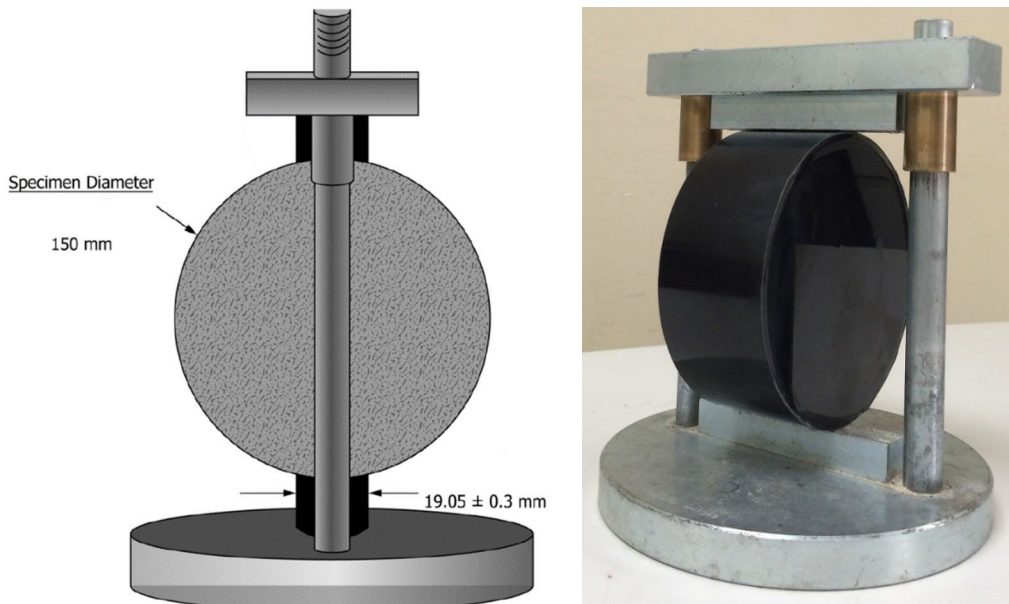

Fig. 2 Traditional Indirect Tension Fixture

- 5.4. Internal Displacement Measuring Device-The displacement shall be measured to a resolution of ± 0.01 mm.
- 5.5. Waterbath-A water bath capable of maintaining $77^{\circ}\text{F} \pm 1.8^{\circ}\text{F}$.

- 5.6. Laboratory Environmental Temperature Control-The laboratory environmental controls shall have provision for heating and cooling within a range of 65°F to 80°F. [See the Department's *Standard Specifications* Section 401.02(A)(item2).]
- 5.7. Control and Data Acquisition System- Time, load, and LLD are recorded. The control data acquisition system is required to apply a constant LLD rate of 2 in/min. and collect data at a minimum sampling frequency of 20 Hz to obtain a smooth load-LLD curve.
- 5.8. Superpave Gyratory Compactor (SGC)-A gyratory compactor and associated equipment for preparing laboratory specimens in accordance with AASHTO T312 shall be used.
- 5.9. Wet Cut Masonry Saw- A laboratory saw capable of trimming field cores may be needed.
- 5.10. Caliper-a caliper accurate to ± 0.1 mm shall be used to measure specimen thickness and diameter.
- 5.11. Pine Instrument Pine 850 TD Workbook, Version 1.02.
- 5.12. KYCT Software Version CT-Test v1.02.1. This software is available as a free distribution from the KYTC MCL Asphalt Section.

6. SAMPLING, TEST SPECIMENS, AND TEST UNITS

6.1 The KYCT may be conducted on laboratory-prepared test specimens or field cores.

6.2 Lab Mix Lab Compacted (LMLC) Asphalt Mixture Samples:

6.2.1 Specimen Size-The specimens shall be 150 mm in diameter by 62 ± 1 mm thick, directly molded in a SGC without cutting or trimming.

6.2.2 Aging-Laboratory-prepared test specimens shall be short-term conditioned uncovered for 4 hours at compaction temperature. Mixtures utilizing PG 64-22 shall be aged and compacted at $265^\circ\text{F} \pm 10^\circ\text{F}$. Mixtures utilizing PG 76-22 shall be aged and compacted at $300^\circ\text{F} \pm 10^\circ\text{F}$. [See KM 64-411(Section 5)(5.2.1)]

6.2.3 Air Void Content-Prepare six gyratory specimens at the target air void content of 7.0 ± 0.5 % using the SGC according to AASHTO T312.

NOTE 1: The specimen air voids are calculated using AASHTO Test Method T269.

NOTE 2: The maximum specific gravity needed to determine the % air voids should be a sample that is fabricated and cured under the same conditions as the KYCT Index specimens.

6.3 Plant Mix Lab Compacted (PMLC) Asphalt Mixture Samples:

- 6.3.1 Specimen Size-The specimens shall be 150 mm in diameter by 62 ± 1 mm thick, directly molded in a SGC without cutting or trimming.
- 6.3.2 Aging-Test specimens prepared from plant produced mixture shall be short-term conditioned uncovered for 2 hours at compaction temperature. Mixtures utilizing PG 64-22 shall be compacted at $265^{\circ}\text{F} \pm 10^{\circ}\text{F}$. Mixtures utilizing PG 76-22 shall be compacted at $300^{\circ}\text{F} \pm 10^{\circ}\text{F}$.

NOTE 3: The best available estimate of time from initiating production of the asphalt mixture to the point of specimen fabrication is an important piece of information. Testing has shown protracted periods of plant storage time can greatly affect the final KYCT-Index values. Accurate determination of this information is needed.

- 6.3.3 Air Void Content-Prepare three to six gyratory specimens at the target air void content of 7.0 ± 0.5 % using the SGC according to AASHTO T312.

6.4 Samples cored from asphalt pavements:

- 6.4.1 Roadway cores can be used if pavement layer thickness is greater than 38 mm. Roadway core specimens shall be 150 ± 2 mm in diameter with all surface of the perimeter perpendicular to the surface of the core within 6 mm. Trim top and bottom surface of all cores to the same thickness with these guidelines.
- 6.4.2 If the thickness of the cores is greater than 62 mm, the top and bottom portions shall be trimmed with a wet masonry saw so that the middle 62 mm section of the core is tested.
- 6.4.3 If the thickness is less than 62 mm, test specimens shall be prepared as thick as possible but in no case be less than 38 mm.

NOTE 4: Care shall be taken to avoid stress or damage to the cores during handling and transportation.

NOTE 5: While a thickness correction can be applied, it is always best to test samples at the same thickness to reduce error.

- 6.4.4 Six KYCT specimens shall be tested.

7. Procedure

- 7.1. After specimen fabrication, precondition test specimens in air at room temperature for 30 ± 5 minutes. During this 30-minute period, after the specimens have cooled sufficiently to handle, determine specimen bulk specific gravity in accordance with AASHTO T166.
- 7.2. Determine the maximum specific gravity of the mixture in accordance with AASHTO T209.
- 7.3. Determine the % air voids of the specimens in accordance with AASHTO T269
- 7.4. At the end of the 30-minute air cure preconditioning, place the KYCT Index specimens in a $77^\circ \pm 1.8^\circ\text{F}$ waterbath for 30 ± 5 minutes.
- 7.5. Inspect the loading strip fixture to ensure all contact surfaces are clean and free of debris.
- 7.6. Ensure that a mass storage device is inserted in the USB drive of the digital output portion of the test press. Turn the test press on.
- 7.7. Remove a specimen from the 77°F water bath, dry quickly on a damp towel and insert the specimen in the fixture. Ensure the specimen is centered and making uniform contact on the support.
- 7.8. Apply load to the specimen in LLD control at a rate of 2 in./min. Allow the test press to conclude the test and stop. During the testing, record the time, load, and displacement at a sampling rate of 20 Hz.

NOTE 6: Carry out loading of specimen until the breaking press completely fractures the specimen in half to ensure that the entire loading curve is recorded.

- 7.9. Testing shall be completed in 1 minute or less after removal from the water bath to maintain a uniform specimen temperature.
- 7.10. Test all the KYCT Index specimens in accordance with items 7.7 to 7.9.
- 7.11. Remove the mass storage device and place in the USB port of a computer containing the Pine Instrument Pine 850 TD Workbook Version 1.02 software.
- 7.12. Import each specimen's data into the appropriate version of MIXPACK and AMAW. Upon final entry of the last specimen's data, save the workbook under a filename known and remembered by the user.
- 7.13. Statistical Outliers: Data will be accepted within a 90 percent statistical confidence level. Outliers will not be considered in the average CT Index calculation.

APPROVED

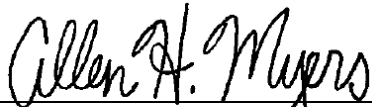

DIRECTOR
DIVISION OF MATERIALS

DATE

05/26/22

Kentucky Method 64-450-22

Revised 05/26/22

Supersedes KM 64-450-19

Dated 06/17/19

NON-TRACKING TACK APPROVAL FOR USE

1. SCOPE:

1.1 The supplier's product must be listed on the Kentucky Product Evaluation List (KyPEL), Phase 3, Experimental or Kentucky's [List of Approved Materials](#) (LAM) prior to placement on a project. New non-tracking tack products not listed in the LAM must meet the requirements listed herein before the product can be listed in KyPEL, Phase 4. All suppliers must meet the requirements of [Kentucky Method \(KM\) 64-445](#) to be listed in KyPEL or LAM.

2. New Non-Tracking Tack Product Requirements for KyPEL.

2.1 The supplier shall contact the Division of Materials (DOM) requesting for the product to be listed in KyPEL for use by the Department and providing information via the internet according to [KM 64-003](#). The Department will require the additional following information along with KM 64-003 requirements:

2.1.1 Provide documentation detailing where the supplier's product has been used and list states, counties, cities, etc., where the product has been approved and/or certified for use.

2.1.2 Provide a technical data sheet showing the minimum and/or maximum test requirements for the supplier's product. Testing requirements shall follow the Department's *Standard Specifications* Section 806 and/or AASHTO procedures.

2.1.2.1 The product must have a Saybolt Furol at 77°F (25°C) viscosity greater than 15 SFS and a Percent Residue greater than 50%.

2.1.2.2 The technical data sheet shall list the expected break and set times of the product. The expected times shall be 15 minutes or less.

2.1.2.3 The bond strength of the product determined by AASHTO TP 114-18 shall be listed on the technical data sheet tested at room temperature. Contrary to AASHTO TP 114-18 the bond strength can also be determined by a breaking press that has a rate of 2 inches/minute.

2.1.2.4 Weather and surface temperature limitations shall be listed on the technical data sheet when the product can be placed.

2.1.2.5 The rate of application for the product must be listed on the technical data sheet.

- 2.1.2.6 How to handle the storage of the product and any requirements for storing the product along with the temperature ranges the product must be heated during storage and placement on the technical data sheet.
 - 2.1.3 Provide safety data sheets for the product.
 - 2.1.4 Submit two one-gallon samples of the product from the source that the request is made to Division of Materials in accordance with [KM 64-404](#).
 - 2.1.5 Provide a quality control plan as according to [KM 64-445](#).
 - 2.2 Once the samples have been tested by the Department and the results verify the product's specifications, the supplier must schedule a trial demonstration on a non-KYTC project.
 - 2.2.1 The producer shall contact the Division of Materials two weeks in advance of the demonstration project. The demonstration project shall be in the state of Kentucky, and the location can be on a county, city, etc., roadway or at a supplier facility. Locations outside of Kentucky may be allowed at the discretion of the Department.
 - 2.2.2 The demonstration must have a minimum existing pavement temperature of 70°F (21°C) or at the discretion of the Engineer.
 - 2.2.3 The distributor used for the demonstration must be calibrated in the presence of the Department.
 - 2.2.4 The product must meet the requirements of the supplier's technical data sheet.
 - 2.2.5 Take a minimum of two cores from the demonstration project in the presence of the Department. Immediately provide the cores to the Engineer at the coring site so that the Department can perform bond testing.
 - 2.3 Once results of the demonstration and bond testing results are satisfactory, the Department will allow the product to be demonstrated on KYTC projects. The supplier will be responsible for finding an interested contractor and a KYTC project to perform the demonstrations. Inform the Division of Materials the location of the project demonstration by county, route, and milepoints. No additional compensation will be given to the contractor for using the product. This demonstration shall follow the same procedures as listed in Section 2.2.
 - 2.4 Once the product meets the reasonable requirements and specifications in KyPEL, the product will be placed on the List of Approved Materials.
3. Procedures to Regain KyPEL or LAM status.
- 3.1 In the event the product fails to meet specifications and/or fails to perform to satisfaction of the Department, the product will be removed from KyPEL and/or LAM. The producer's product will be required to meet the requirements listed below to be reinstated to KyPEL:

3.1.1 The Department will require the producer to provide written documentation that details the reason(s) why the product failed to perform and/or meet specifications and details changes that were made to eliminate the cause(s) of failure.

3.1.2 Proposed changes to the specifications of the product.

3.1.3 Submit two-one gallon samples of the newly revised product to Division of Materials along with new product specifications.

3.1.4 Perform a demonstration on projects as outlined in section 2 of this KY Method.

3.2 Once the demonstration and test results have satisfactory results, the Department may consider reinstating the product in the LAM.

APPROVED

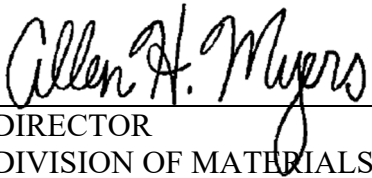

DIRECTOR
DIVISION OF MATERIALS

DATE

06/17/19

Kentucky Method 64-451-19
Revised 06/17/19

DETERMINING THE CALIFORNIA BEARING RATIO OF
LABORATORY COMPACTED SOILS AND SOIL - AGGREGATE MIXTURES

1. SCOPE: This method describes the procedures employed in determining the California Bearing Ratio (CBR) for Soils or Soil-Aggregate samples when compacted and tested in the laboratory, by comparing the penetration load of the material to that of a standard material.
2. APPARATUS:
 - 2.1. Loading Device: A compression-type apparatus with a movable head or base such that it is capable of applying a uniformly increasing load up to 60,000 lb at a rate of 0.05 in. per min. The device shall be equipped with a load indicating device that can be read to 10 lb or less.
 - 2.2. Molds: The molds shall be cylindrical in shape, made of metal, with an internal diameter of 6.0 ± 0.026 in. and a height of 7.0 ± 0.018 in. Each mold shall be machined to fit a removable perforated base and two slotted flanges by means of which it is bolted to its base.
 - 2.3. Compacting Plunger: A metal unit approximately 5 in. in height with a diameter that allows approximately 0.002 in. clearance with the mold walls. The plunger shall have flat, smooth end surfaces.
 - 2.4. Surcharge Plates and Weights: A perforated metal disc approximately 5.875 in. in diameter 0.25 in. thick, having in its center a threaded metal stud bolt. This stud is fitted with a threaded lock washer and a threaded sleeve nut. Each surcharge plate shall weigh 2.5 ± 0.10 lb and is weighted by removable metal weights, each weighing 5 ± 0.10 lb.
 - 2.5. Apparatus for Measuring Expansion: A dial indicator is mounted stem downward on a tripod. The unit is designed to be placed on the rim of the mold and permit the stem to make contact with the top of the sleeve nut of the surcharge plate with respect to a datum. The dial indicator shall have a 1 in. throw and read to 0.001 in.
 - 2.6. Penetration Pin or Piston: A metal pin or piston of circular cross-section having a diameter of 1.954 ± 0.005 in. (area = 3.0 in^2) and approximately 7.5 in. in length.
 - 2.7. Dial Indicator for Measuring Deformation: The indicator is mounted such that the stem of the indicator is in contact the testing machine head in order to measure the penetration of the specimen. The dial indicator shall have a 1 in. throw and read to 0.001 in.
 - 2.8. Soaking Tank: A soaking tank suitable for maintaining the water level 1 in. above the top of the molds.
 - 2.9. Miscellaneous: Miscellaneous tools such as mixing pans, spoons, straightedge, filter

paper, balances, sieves, moisture content containers, drying oven for determining moisture contents, etc.

3. PROCEDURE:

3.1. Preparation and Design of the CBR Test Specimens:

- 3.1.1. The material to be used in the CBR test shall have been initially prepared in the manner described by AASHTO T 87. According to AASHTO T 87, samples shall not be subjected to drying temperatures above 140° F; all samples prepared by AASHTO T 87 are considered to be air dried regardless of whether an oven or other drying apparatus is used.
- 3.1.2. The quantities of material required for a CBR test specimen are computed from the maximum dry density obtained from the [KM 64-511](#) (Moisture-Density Relations) test. It is an amount sufficient to yield a volume of 0.0818 ft³ in the CBR mold, 5.0 in. in depth and 6.0 in. in diameter, when the material is at optimum moisture condition.
- 3.1.3. When CBR test specimens are prepared, the hygroscopic moisture content should be determined on the material finer than the No. 4 sieve to properly compensate for the hygroscopic moisture in the specimen design computations. The preferred method of determining the hygroscopic moisture content is by AASHTO T 265 using a minimum sample size of 100 g. If the hygroscopic moisture cannot be determined by AASHTO T 265 due to time or other constraints, AASHTO T 217 may be used.
- 3.1.4. When material coarser than the No. 4 sieve is to be incorporated into the CBR specimen all such particles shall pass the 3/4 in. sieve.
- 3.1.5. Masses for the CBR Test Specimen Designs shall be calculated to the nearest gram. Examples of Proper CBR Test Specimen Design Computations are presented in [Appendix A](#).
- 3.1.6. All materials for the test specimen shall be thoroughly mixed by hand until the mix appears to be approximately uniform.

3.2. Compacting and Soaking Specimen:

- 3.2.1. After the material has been mixed, it is placed in the mold; it may be necessary to lightly compact the material, by hand, using a mallet, or by another comparable method, to get all the material in the mold. A filter pad with a diameter of approximately 5 in. is visually centered in the mold and placed on top of the specimen. The compaction plunger is inserted into the mold on the specimen and a pressure of 2000 psi, or a load of 56,550 lb is applied gradually over a 2 minute interval.
- 3.2.2. After removal of the compaction plunger, three surcharge weights and the surcharge plate, totaling 17.5 ± 0.5 lb are inserted into the mold to rest on the

compacted specimen.

- 3.2.3. The specimen is placed in the soaking tank and a height measurement is taken using the indicator mounted on the tripod. The water shall be maintained a minimum of 1 in. above the top of the mold.
- 3.2.4. The length of time the sample is allowed to remain submerged in the tank is dependent upon the amount of swell indicated by height readings taken daily. Measurements are taken until successive readings (taken 24 hours apart) differ by not more than 0.003 in. The minimum soaking period, regardless of swell, is 3 days and the maximum is 15 days.

3.3. Load Bearing Test:

- 3.3.1. Following the soaking period the mold is thoroughly drained of free water, the surcharge weights and plate are removed and the mold assembly placed in the loading device. A 5 lb weight is placed on the surface of the specimen, and the loading penetration piston is placed uprightly and centered on the surface of the specimen exposed through the hole in the weight. A seating load of 10 ± 0.2 lb is applied to the piston.
- 3.3.2. The dial indicator for the penetration reading and the load indicator are zeroed.
- 3.3.3. The load is applied so that the rate of penetration of the piston into the specimen is 0.05 in. per minute. Load readings are obtained when the depth of penetration has reached 0.010, 0.025, 0.050, 0.075, 0.10, 0.20, 0.30, 0.40, and 0.50 in.

3.4. Calculation of Bearing Ratio:

- 3.4.1. The penetration stresses (psi) are calculated for all penetration readings and a Stress vs. Penetration curve is plotted. The curve may be concave upward initially because of surface irregularities, or other causes. To obtain the true Stress vs. Penetration relationships, correct the curve having concave upward shape near the origin by adjusting the location of the origin by extending the straight-line portion of the curve downward until it intersects the abscissa. A Typical Stress vs. Penetration plot is shown in [Figure 1](#).
- 3.4.2. The bearing ratio is calculated by expressing the stress (load per unit area of the penetration pin or piston) at the 0.1, 0.2, 0.3, 0.4, and 0.5 in. penetration depths as a percentage of the following respective standard reference stress values. In all cases, the CBR value assigned to a material is the lowest of the five penetration calculations.

Penetration (in.)	Standard Reference Stress (psi)
0.1	1000
0.2	1500
0.3	1900
0.4	2300
0.5	2600

3.4.3. [Table 1](#) illustrates the calculations involved in determining a CBR value. These calculations are applicable to the curve plotted in Figure 1.

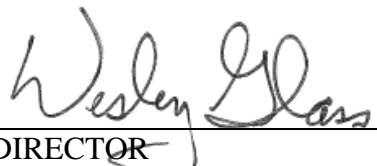
APPROVED 

 DIRECTOR
 DIVISION OF MATERIALS

DATE 02/26/08

Kentucky Method 64-501-08
 Revised 02/26/08
 Supersedes KM 64-501-02
 Dated 11/14/02

Attachments

APPENDIX A: EXAMPLES OF PROPER CBR TEST SPECIMEN DESIGN COMPUTATIONS

EXAMPLE # 1 - Sample of Soil Only (All Material Finer than the No. 4 Sieve) -

Given Conditions:

- (1) KM 64-511 Test Results:

$$\gamma_{d \max} = 110 \text{ lb/ft}^3 \quad \text{maximum dry density}$$

$$w_{\text{opt}} = 14 \% \quad \text{optimum moisture content}$$

- (2) $w_{\text{hyg}} = 2.0\%$ hygroscopic moisture content of the air-dry soil to be used

- (3) $V_{\text{mo}} = 0.0818 \text{ ft}^3$ volume of the mold occupied

Calculate the masses of material required for CBR test specimen as follows:

- (1) Calculate the theoretical mass of dry soil, M_{ds} .

$$M_{\text{ds}} = \gamma_{d \max} V_{\text{mo}} = \left(110 \frac{\text{lb}}{\text{ft}^3}\right) (0.0818 \text{ ft}^3) \left(453.6 \frac{\text{g}}{\text{lb}}\right) = 4081 \text{ g}$$

- (2) Calculate the mass of air-dry soil, M_{ads} .

$$M_{\text{ads}} = M_{\text{ds}} \left(1 + \frac{w_{\text{hyg}}}{100}\right) = 4081 \text{ g} \left(1 + \frac{2.0}{100}\right) = 4163 \text{ g}$$

- (3) Calculate the mass of water to be added to the air-dry soil, M_{wa} , to bring it to the optimum moisture content.

$$M_{\text{wa}} = M_{\text{ds}} \left(\frac{w_{\text{opt}} - w_{\text{hyg}}}{100}\right) = 4081 \text{ g} \left(\frac{14 - 2.0}{100}\right) = 490 \text{ g}$$

- (4) The CBR test specimen design is as follows:

4163 g air-dried soil
490 g water added to soil

EXAMPLE # 2 - Soil-Aggregate Mixture Sample

Given Conditions:

- (1) KM 64-511 Test Results:

$\gamma_{d \max} = 125 \text{ lb/ft}^3$ maximum dry density of composite materials

$w_{\text{opt}} = 10\%$ optimum moisture content

- (2) $F_4 = 60.0\%$ percent finer than the no. 4 sieve

- (3) $w_{\text{hyg}} = 2.0\%$ hygroscopic moisture content
of the air-dry soil finer than the no. 4 sieve

- (4) $V_{\text{mo}} = 0.0818 \text{ ft}^3$ volume of the mold occupied

Note: In preparation, or design, of a soil-aggregate sample for the CBR test, it is deemed impractical to make all adjustments and compensations for moisture present in the coarse fraction which would provide for absolute theoretically correct design masses. The procedures and computations illustrated hereinafter are those employed by the Division of Materials, Geotechnical Branch, in the design of a CBR test specimen for a soil-aggregate sample.

Calculate the masses of material required for CBR test specimen as follows:

- (1) Calculate the theoretical mass of dry soil finer than the No. 4 sieve, M_{df4} .

$$M_{df4} = \gamma_{d \max} V_{\text{mo}} \left(\frac{F_4}{100} \right) = \left(125 \frac{\text{lb}}{\text{ft}^3} \right) (0.0818 \text{ ft}^3) \left(\frac{60.0}{100} \right) \left(453.6 \frac{\text{g}}{\text{lb}} \right) = 2783 \text{ g}$$

- (2) Calculate the mass of air-dry soil finer than the No. 4 sieve, M_{adf4} .

$$M_{adf4} = M_{df4} \left(1 + \frac{w_{\text{hyg}}}{100} \right) = 2783 \text{ g} \left(1 + \frac{2.0}{100} \right) = 2839 \text{ g}$$

- (3) Calculate the mass of soil coarser than the No. 4 sieve, M_{c4} .

$$M_{c4} = \gamma_{d \max} V_{mo} \left(1 - \frac{F_4}{100}\right) = \left(125 \frac{\text{lb}}{\text{ft}^3}\right)(0.0818 \text{ ft}^3) \left(1 - \frac{60.0}{100}\right) \left(453.6 \frac{\text{g}}{\text{lb}}\right) = 1855 \text{ g}$$

Note: In the calculation above it is assumed that the material coarser than the No. 4 sieve contains no hygroscopic moisture or the air-dry and dry masses are identical.

- (4) Calculate the mass of water to be added to the sample, M_{wa} , to bring it to the optimum moisture content.

$$M_{wa} = (M_{df4} + M_{c4}) \left(\frac{w_{opt} - w_{hyg} \left(\frac{F_4}{100} \right)}{100} \right)$$

$$= (2783 \text{ g} + 1855 \text{ g}) \left(\frac{10 - 2.0 \left(\frac{60.0}{100} \right)}{100} \right) = 408 \text{ g}$$

- (5) The CBR test specimen design is as follows:

2839 g	air-dry soil finer than the no. 4 sieve
1855 g	soil coarser than the no. 4 sieve
408 g	water added to sample

TABLE 1 - CBR CALCULATIONS FROM FIGURE 1 CURVES

Curve A (No Correction Required)						
Penetration	Load	Stress	Corrected Stress	Standard	CBR	Assigned
0.010	60	20				<u>14.0</u>
0.025	155	52				
0.050	305	102				
0.075	465	155				
0.1	615	205	205	1000	20.5	
0.2	950	317	317	1500	21.1	
0.3	1020	340	340	1900	17.9	
0.4	1068	356	356	2300	15.5	
0.5	1095	365	365	2600	14.0	
Curve B (Corrected for Surface Irregularities)						
0.010	10	3				<u>11.7</u>
0.025	45	15				
0.050	130	43				
0.075	215	72				
0.1	300	100	117	1000	11.7	
0.2	655	218	232	1500	15.5	
0.3	875	292	297	1900	15.6	
0.4	945	315	317	2300	13.8	
0.5	975	325	325	2600	12.5	
Curve C (Corrected for Concave Upward Shape)						
0.010	5	2				<u>9.2</u>
0.025	20	7				
0.050	40	13				
0.075	80	27				
0.1	140	47	92	1000	9.2	
0.2	410	137	182	1500	12.1	
0.3	680	227	260	1900	13.7	
0.4	850	283	295	2300	12.8	
0.5	900	300	302	2600	11.6	

$$Stress (psi) = \frac{Load (lb.)}{3.0 in.^2} \quad CBR = \left(\frac{Corrected Stress}{Standard Reference Stress} \right) \times 100$$

Kentucky Method 64-502-08
Revised 04/01/08
Supersedes KM 64-502-02
Dated 11/21/02

CONSOLIDATED, UNDRAINED TRIAXIAL COMPRESSION TEST ON COHESIVE SOILS

Refer to *Standard Method Of Test For Consolidated, Undrained Triaxial Compression Test On Cohesive Soils - AASHTO T 297-94* with the following additions and modifications:

Pocket penetrometer and/or Torvane tests shall be performed on each sample prior to testing and the results shall be recorded on the data sheets. For Torvane tests, the size of the vane used shall be indicated. These tests shall be performed on a portion of the sample that will be removed during the sample trimming process.

- 1.3. The actual number of tests to be used is left to the discretion of the engineer responsible for the project.
- 5.13. Filter-paper strips or a filter-paper cage is required.
- 7.2.1.2. It is not necessary to boil the porous disks for every test. However, disks should be boiled approximately once every month. If disks are not boiled every time the test is run, they should be kept in water and not allowed to dry between tests.
- 7.2.2.1 & 7.2.2.2. May be omitted.
- 8.2 to 8.2.4.4. The procedures outlined are suggested procedures. Many other procedures have been developed that adequately accomplish saturation.
- 8.2.4.2. A plot of Δu versus time is not required.
- 8.3.3. An alternate method of consolidation is to obtain an initial burette reading and then open appropriate drainage valves so that the specimen may drain from one end of the sample. Pore pressure shall be monitored from the other end of the sample. Allow the sample to consolidate overnight. Prior to shear, close the appropriate valves and obtain a burette reading.
- 8.3.4 & 8.3.5. Omit if the alternate method of consolidation specified above is used.
- 8.4.2. If the alternate consolidation method specified above is used, the rate of axial strain shall be 0.03 to 0.04 percent per minute. The test may be terminated when a sufficient number of readings have been obtained to plot the stress path as described in 10.5.
- 10.1. Calculating and recording the volume of solids, initial void ratio, initial degree of saturation, and initial dry unit weight are not required. The initial total unit weight must be calculated and recorded.
- 10.4. May be omitted.
- 10.6 to 10.7.1. May be omitted.

- 10.8. Determination of major and minor principal stresses at failure based on total stress is not required.
- 10.9. Construction of Mohr stress circles at failure based on total stress is not required.
- 11.1.2 to 11.1.4. May be omitted if presented on other data sheets or in other reports.
- 11.1.5. Reporting of initial specimen dry unit weight, void ratio, and percent saturation are not required. The initial water content and total unit weight must be reported.
- 11.1.11. This section shall be omitted if the alternate consolidation method specified above is used.
- 11.1.12. Reporting of specimen dry unit weight, void ratio, and percent saturation after consolidation are not required. The water content and total unit weight after shearing must be reported.
- 11.1.18. May be omitted.
- 11.1.20. Mohr stress circles based on total stresses are not required.

APPROVED 

 DIRECTOR
 DIVISION OF MATERIALS

DATE 04/01/08

Kentucky Method 64-502-08
 Revised 04/01/08
 Supersedes KM 64-502-02
 Dated 11/21/02

MEASUREMENT OF PORE PRESSURE IN SOILS

1. SCOPE:
 - 1.1. This method covers procedures for determining field pore pressure measurements in the natural soils.
 - 1.2. This does not include methods of pore pressure measurements in the laboratory or field installations in dams.
2. APPARATUS:
 - 2.1. Vibrating Wire Piezometer. This consists of a transducer constructed of a sensitive diaphragm with a vibrating wire element attached to it. The transducer is covered by a porous stone that allows fluid to pass through but prevents soil particles from contacting the transducer. Fluid pressure acting on the diaphragm changes the tension and frequency of the vibrating wire. This change is sensed and transmitted to a readout device by means of an electrical coil acting through the walls of the capsule. Two types of vibrating wire piezometers are available; standard and drive point.
 - 2.2. Pneumatic Piezometer. This consists of a pneumatic pressure transducer in a plastic or stainless steel case with a porous, ceramic, plastic or metal opening to allow the pore water to reach the transducer diaphragm. Two small diameter plastic air leads are connected to the transducer. A supply of compressed air, bottle compressed or liquefied gas, (clean and without moisture) is required to operate the transducer. An air pressure gage of sufficient capacity to record the existing pressure at the depth of the piezometer tip plus the expected pore pressure is needed.
 - 2.3. Observation Well: Consists of an open hole supported by perforated casing.
3. INSTALLATION EQUIPMENT:
 - 3.1. Any drilling equipment that provides a reasonably clean bore hole a minimum of 4 inches in diameter before insertion of the piezometer or casing. If a drive point piezometer is used, a special attachment is needed to push the piezometer into the soil.
 - 3.2. Tamping hammer of sufficient size for tamping the bentonite layers, thereby assuring a watertight seal. Galvanized airplane cable 1/8 inch diameter should be securely fastened to one end of the hammer and marked at 5 foot intervals, starting at the bottom face of the hammer. This will make it possible to measure depths at various stages of installation.
 - 3.3. Ottawa sand or a thoroughly washed sand passing the no. 20 sieve and retained on the no. 40 sieve.
 - 3.4. Bentonite balls or compressed bentonite pellets for sealing the hole above the piezometer.

- 3.5. Rounded pebbles approximately 1/2 inch diameter.
- 3.6. Splicing kits and tools for splicing lines. Any means of splicing is suitable as long as it makes an air tight seal.
- 3.7. Casing for observation wells.

4. INSTALLATION PROCEDURES:

4.1. Pneumatic and standard vibrating type wire piezometers:

- 4.1.1. Prepare the piezometer for installation. Connect the riser tubes to the piezometer in such a manner that they will not easily become disconnected. The tubing should be of sufficient length without splices to extend at least 10 feet above the ground surface. Measure from the tip of the piezometer to a point on the tubing a distance that will be 1 foot above the ground surface and mark this point on the tubing. This may be used as a future reference point during installation. Plug the end of the tube or tubes to prevent the entrance of foreign matter during installation. Mark the tubes to distinguish between the in tube and out tube.
- 4.1.2. Advance the hole to the approximate elevation of the top of the piezometer cell. Obtain a spoon sample of the material for 18 inches below this elevation. After removal of the sample examine it for possible sand lenses. If sand lenses exist it may be necessary to install the piezometer at another depth since the sand may act as drainage paths for the clay layer. The sample should be sealed in a jar for future study or testing. Advance the hole to 2 feet below the approximate piezometer tip elevation. In most cases soil conditions permit the hole to remain open encased. Therefore, withdraw the augers or casing from the hole in such a way to cause a minimum amount of disturbance to the hole. Examine the hole to make sure it is open. If the hole does not stay open, then advance the augers or casing again, and install the piezometer through the casing.

NOTE: When installing inside the casing, follow the same procedure as outlined, withdrawing the casing as the respective layers are put in place. Piezometers can be installed faster and with less difficulty in most cases in an uncased hole.

- 4.1.3. Pour approximately 2 feet of sand into the hole. This amount can be calculated when the diameter of the hole is known. When installing below an existing water table the sand shall be saturated.
- 4.1.4. Lower the piezometer into the hole and pour in sand to an approximate elevation of 2 feet above the top of the piezometer while maintaining tension on the tubing but do not permit any vertical movement of the piezometer. Add enough 1/2 inch diameter pebbles to form a 1 inch thick layer on top of the sand and tamp adequately. Maintain the tension on the tubing at all times.
- 4.1.5. Drop bentonite balls or compressed bentonite pellets into the hole to form a 6 inch thick layer, then cover with a 1 inch thick layer of 1/2 inch diameter pebbles. (When using compressed pellets, volume charts are usually available from the

manufacturer. When installing under the water table it may be possible to measure the thickness of the layer by the increase in height of the water table.) Lower the tamper into the hole and tamp.

4.1.6. Repeat step 4.1.5 until at least a 4 layer seal is formed. (Whenever the tamper does not move freely, it should be withdrawn and cleaned.) The remaining depth may be filled with competent material of low permeability.

4.1.7. The piezometer lines may be extended in one of two ways:

4.1.7.1. Vertically through the embankment fill in any suitable manner provided that (1) adequate protection is provided.

4.1.7.2. Excavate a trench at least 2 feet deep by 1 foot wide from the piezometer location to the read-out area. (This area shall be out of the construction limits.) The lines shall be layered in a zigzag pattern in the trench. Tubing or wires must not be stretched taut prior to backfill. Before backfilling slack of 1 to 3 feet per 100 feet of trench length should be left in the wire or tubing to prevent differential settlement to damage the tubing or wire. When the soil underlying the lines is not free of rock or material that might cause injury to the lines, 6 inches of sand shall be used as a bedding and cover. The remainder of the trench shall be backfilled with excavated material. The lines shall be extended up a post at the end of the trench and an elevation marked at some point on the post. The lines should be stored within a protective cover where they are accessible to the pore pressure readout indicator.

4.1.8. Saturation:

4.1.8.1. After installation, apply a vacuum to the end of the tube and plug the in tube. Vacuum for 15 minutes in order to remove the air from the piezometer and tubing. Submerge the in tube in clear water and continue vacuuming until the tubing is void of air. The pore pressure may be calculated after equalization by measuring the elevation of the water in the tubes. Bourdon tube gages may be installed as a means of observing the pore pressures. When freezing conditions exists, some form of antifreeze shall be added to the lines.

4.1.8.2. For vibrating wire type piezometers the piezometer should be placed in water for 15 minutes. After saturation connect the wires to readout box to ensure proper functioning of piezometer, and take an initial reading.

4.2. Drive Point Vibrating Wire Piezometer:

4.2.1. Advance sample hole through subject soil strata to be monitored, sampling every 5 feet or when soil characteristics change. Record depths of soil layers desired for

piezometer installation. A separate bore hole will need to be drilled for each piezometer to be installed, unless standard type vibrating wires will be installed above the drive point piezometer.

- 4.2.2. Locate each bore hole for each of the Drive Point Vibrating Wire Piezometers to be installed approximately 3 feet apart from initial bore hole and other piezometers. Each bore hole is to be advanced to a depth of 5 feet above the intended level of the piezometer installation depth. Withdraw the casing or augers from the bore hole, and ensure that the hole is open. If hole has closed off or an obstruction has fallen into the hole re-advance the augers or casing and install piezometer through hollow center of casing or auger.

NOTE: DO NOT damage the wire or protective plastic coating during installation of piezometer. If any damage occurs to wire or cover it must be repaired by waterproofing the cover or splicing the wire.

- 4.2.3. The piezometer should be connected to the specially designed push rod with the wire from the piezometer fed through the center of the rod. Attach the push rod to the required number of drill extension rods needed to achieve the depth of penetration needed to install the piezometer at the correct elevation. Place the piezometer into the hole and attach the extension rods to the drill rig. Adjust the pressure controls of the drill so that the piezometer can be pushed into the soil in a smooth continuous action that will not over stress the piezometer. To ensure proper functioning of the piezometer and that it is not overstressed the readout box needs to be attached and monitored during installation.
 - 4.2.4. Once piezometer is located at desired depth, rotate the extension rods counter-clock wise to unscrew the piezometer and push rod from the extension rods. Raise the extension rods out of the bore hole. Drop bentonite balls or pellets into the bore hole to form a 6 inch thick layer and tamp bentonite into place with tamper.
 - 4.2.5. Additional Standard type vibrating wire or pneumatic piezometers can be installed in the bore hole.
 - 4.2.6. Backfill the bore hole with the natural soil taken from site, including auger trailings and trench excavation. Take special care to separate large rocks that might damage the piezometer from the backfill soil.
 - 4.2.7. Follow same procedures as [4.1.7](#) and [4.1.8.2](#) for extending piezometer lines, and testing of the piezometer.
- 4.3. Observation Wells: Advance the hole to the soil layer in which pore pressure is to be obtained, and install perforated casing. Perforations shall be not larger than 3/8 inch diameter. The hole shall be backfilled to within approximately 3 feet of the surface. Granular backfill material is desirable, if available. However, local material may be used if granular material is not available. The hole shall be capped to prevent the entrance of foreign matter and sealed to prevent the entrance of surface water.

5. INTERPRETATION OF DATA: Corrections to Pore Pressure Reading:
 - 5.1. Vibrating Wire Type: The pore pressure head is determined by inputting the reading and temperature differences from initial reading and temperature into an equation. The piezometer manufacturer provides this equation, with the needed factors to convert the readings to pressure head.
 - 5.2. Pneumatic: The excess pore pressure head is determined by subtracting the difference in elevation between the piezometer tip and the elevation obtained from the pore pressure readout indicator.
 - 5.3. Observation Wells: The excess pore pressure head is the difference between the elevation of the water in the well and the general water table elevation.

6. SPECIAL PROBLEMS: The following special problems occur with sufficient frequency to warrant discussion:
 - 6.1. Gas Lock: In many organic soils, the gas generated around the piezometer tip is sufficient to block entrance of the pore water through the filter into the measuring device. Where this is expected to be a problem special piezometers are available with flushing devices to remove the gas from the piezometer tip.
 - 6.2. Large settlements: In areas where large foundation settlements occur, numerous problems have developed.
 - 6.2.1. Crimping of the riser tube below the end of a permanent casing installation: This is eliminated by installing the piezometer inside the casing.
 - 6.2.2. Crimping of the riser at the top of the permanent casing: This is eliminated by removing the top section of casing to about 5 feet below ground surface and backfilling with sand.
 - 6.2.3. Stretching of the horizontal leads: This is acceptable for most installations provided that no connections are made in the horizontal leads and the leads are made of materials having yield before rupture.

APPROVED

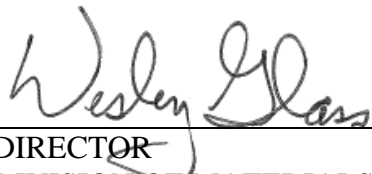

 DIRECTOR
 DIVISION OF MATERIALS

DATE

02/26/08

Kentucky Method 64-503-08
 Revised 02/26/08
 Supersedes KM 64-503-03
 Dated 01/08/03

Kentucky Method 64-511-08
Revised 04/01/08
Supersedes KM 64-511-03
Dated 01/23/03

MOISTURE-DENSITY RELATIONS (PROCTOR DENSITY)

Refer to Standard Method of Test for Moisture-Density Relations of Soils Using a 2.5-kg (5.5 lb.) Rammer and a 305 mm (12-in.) Drop – AASHTO T 99-01 (2004) with the following additions and modifications:

- 1.3 This test method applies to soil mixtures that have 40 percent or less retained on the No. 4 sieve, when Method A is used, and 30 percent or less retained on the $\frac{3}{4}$ in. sieve, when method C is used. The material retained on these sieves shall be defined as oversized particles (coarse particles).
- 3.1.3. Molds Out of Tolerance Due to Use - A mold that fails to meet manufacturing tolerances after continued service may remain in use provided those tolerances are not exceeded by more than 100 percent; and the volume of the mold, calibrated in accordance with Section 8 (Calibration of Measure) of AASHTO T 19 is used in the calculations.
- 4.2. Sieve an adequate quantity of the representative pulverized soil over the No. 4 sieve. If the quantity of material retained on the No. 4 sieve is greater than five percent, follow the procedures outlined in Method C.
- 8.2. Sieve an adequate quantity of the representative pulverized soil over the $\frac{3}{4}$ in. and No. 4 sieve. Record the quantity of material retained on the No.4 and $\frac{3}{4}$ in. sieve. The quantity of material retained on the $\frac{3}{4}$ inch shall be used to adjust the compacted specimen density to field density in accordance with AASHTO T 224.
- 14.1.4. In Method C, indicate the quantity of material retained on the No. 4 and $\frac{3}{4}$ inch sieve.
- 14.1.6. See figures 1 and 2 for sample data sheets.

SECTION 16 METHOD E PROCEDURE (STABILIZED AGGREGATE BASE)

- 16.1. Combine in mix percentages representative samples of dry ingredients for the stabilized aggregate base to a sample weight of 6000 grams (a separate sample will be needed for each point desired using a new sample for each compaction test)
- 16.2. Add water and mix thoroughly to dampen to approximately four percentage points below estimated optimum moisture content. Compact the stabilized aggregate base mixture as in Method A except use the 6-in. mold and 56 blows per layer. Following compaction remove the extension collar; carefully trim the compacted material flush with the top of the mold. In trimming the compacted specimen, holes may develop by removal of coarse particles; these may be patched with fine particles. Weigh the mold inclusive of the compacted material and determine the wet density according to the procedure described in Section 5.2.1.
- 16.3. Remove the material from the mold and weigh immediately. Place the entire compacted specimen in an oven and dry to a constant weight to determine the moisture content in accordance with

AASHTO T 255.

- 16.4. Using a new portion of aggregate each time (6000 grams) repeat 5.2 and 5.2.1 for each determination while adding water in approximately 2% increments (120 grams). Continue adding water in increments and compact until there is either a decrease or no change in the weight of the compacted aggregate plus mold.

SECTION 17 Procedure For Field Correction Of Moisture Density Test Results for Variations in Percent Retained on the No.4 Sieve.

- 17.1. Compacted specimen density determined using Method A or C shall be corrected in accordance with AASHTO T224 for field density purposes if the quantity of plus No. 4 material is greater than 5 percent. The preferred method of determining maximum density of samples with greater than 5% plus No. 4 material is Method C. However, it may be necessary to correct the results of Method A in some cases for oversized particles.

APPROVED

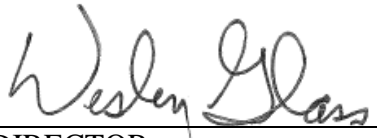

DIRECTOR
DIVISION OF MATERIALS

DATE

04/01/08

Kentucky Method 64-511-08
Revised 04/01/08
Supersedes KM 64-511-03
Dated 01/23/03

ONE POINT PROCTOR METHOD

1. SCOPE: The “One-Point Method” is a test for the rapid determination of the maximum density and optimum moisture content of a soil sample utilizing a family of curves and a one-point determination.
2. DEFINITION: A Family of Curves is a group of typical soil moisture-density relationships determined using T 99, which reveal certain similarities and trends characteristic of the soil type and source. Soils sampled from one source will have many different moisture-density curves, but if a group of these curves are plotted together certain relationships usually become apparent. In general it will be found that higher unit mass soils assume steeper slopes with maximum dry densities at lower optimum moisture contents, while the lower unit mass soils assume flatter more gently sloped curves with higher optimum moisture. The one-point proctor method should not be used in lieu of the “multi-point” moisture density test. It may be used to verify changes in maximum density and optimum moisture indicated by a nuclear density test that fails to meet specified density requirements even though operations have not changed and previous tests have passed. It may be used when time does not permit a “multi-point” test, i.e., the inspector is unsure which target density to use when the contractor is placing material.
3. PROCEDURE:
 - 3.1. Obtain a representative sample of soil, approximately 3000 grams should be sufficient, however if the sample contains plus No. 4 material a larger sample may be needed. When verifying a nuclear density test the sample should be taken directly below where the test was run.
 - 3.2. Sieve the material through a No. 4 sieve. Make sure all soil particles pass and only granular material, if any, is retained. Allow the -4 material to dry or add water until the sample is approximately 2 to 4 percentage points below optimum. The moisture content should never exceed optimum.
 - 3.3. Weigh the -4 and + 4 material separately and record. The plus 4 material may be discarded after weighing.
 - 3.4. Using the -4 material, compact 3 equal layers in the proctor mold by 25 uniformly distributed blows from a 12 inch height. Make sure the mold is setting on a solid foundation such as a headwall or concrete pavement.
 - 3.5. Remove the top collar and trim the compacted material with a straight edge knife until it is even with the top of the mold.
 - 3.6. Brush any loose material from the outside of the mold and base plate. Weigh and record the weight of the mold and sample.
 - 3.7. Extrude the sample from the mold and perform a moisture test on a representative sample

from the center of the plug using the Speedy Moisture Tester or other approved methods.

- 3.8. Calculate the wet weight per cubic foot of the compacted material as follows:

$$F = \text{Mold constant (D-E)}$$

Where:

F = Weight per cubic foot

D = Weight of wet soil and mold

E = Weight of mold

Example:

$$D = 5901, \quad E = 4034$$

$$F = .06614 (5901 - 4034)$$

$$F = 123.5 \text{ pcf}$$

- 3.9. Using the [Family of Curves](#) determine the maximum density and optimum moisture of the minus No.4 material.

Example: Given wet weight = 123.5, moisture = 16.3

Follow the horizontal line representing the wet weight of 123.5 across the chart until it intersects the vertical line representing the moisture of 16.3. The typical curve lying nearest the point of intersection is curve 19. From the dry density chart the maximum dry density for curve 19 is 107 pcf and an optimum moisture of 18%.

- 3.10. Calculate the percent of sample retained on the No. 4 sieve as follows:

$$C = A / (A + B') \times 100$$

C = percent retained on the No. 4 sieve

A = weight of plus No. 4 material

B' = dry weight of minus No. 4 material = $B / 1 + \text{moisture of } -4 \text{ material (M)}$

Example: A = 1000 grams, B = 4000 grams, B' = $4000 / 1.163 = 3439$ grams

$$C = 1000 / (3439 + 1000) \times 100 = 22.5\%$$

When the amount of plus No. 4 material exceeds 5% the maximum dry density adjusted for the plus No. 4 material shall be determined in accordance with AASHTO T- 224 by using the chart in Figure 1 or by the following equation:

$$H = (1.0 - C') G + 149C'$$

H = adjusted maximum dry density

C' = percent retained on the No. 4 sieve expressed as a decimal

G = maximum dry density of the minus No. 4 material

Example: C' = .225 (22.5%), G = 107 pcf

KM 64-512-08

$$H = (1.0 - .225) 107 + (149 \times .225)$$
$$H = 83 + 33.5 = 116.5 \text{ pcf}$$

The optimum moisture is adjusted by the following equation:

$$J = I \times 1 - (C/100) + (C/50)$$

J = optimum moisture of the total sample

I = Optimum moisture of the minus No. 4 material

C = percent retained on the No. 4 sieve

Example: I = 18%, C = 22.5%

$$J = 18 \times 1 - (22.5/100) + (22.5/50)$$

$$J = 18(.775) + .45$$

$$J = 14.5 \%$$

Therefore the adjusted maximum dry density and optimum moisture for the sample used in our example would be 116 pcf and 14.5%.

APPROVED

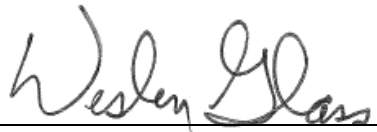

DIRECTOR
DIVISION OF MATERIALS

DATE

02/26/08

Kentucky Method 64-512-08

Revised 02/26/08

Supersedes KM 64-512-02

Dated 11/19/02

Attachments

Moisture Density Family of Curves

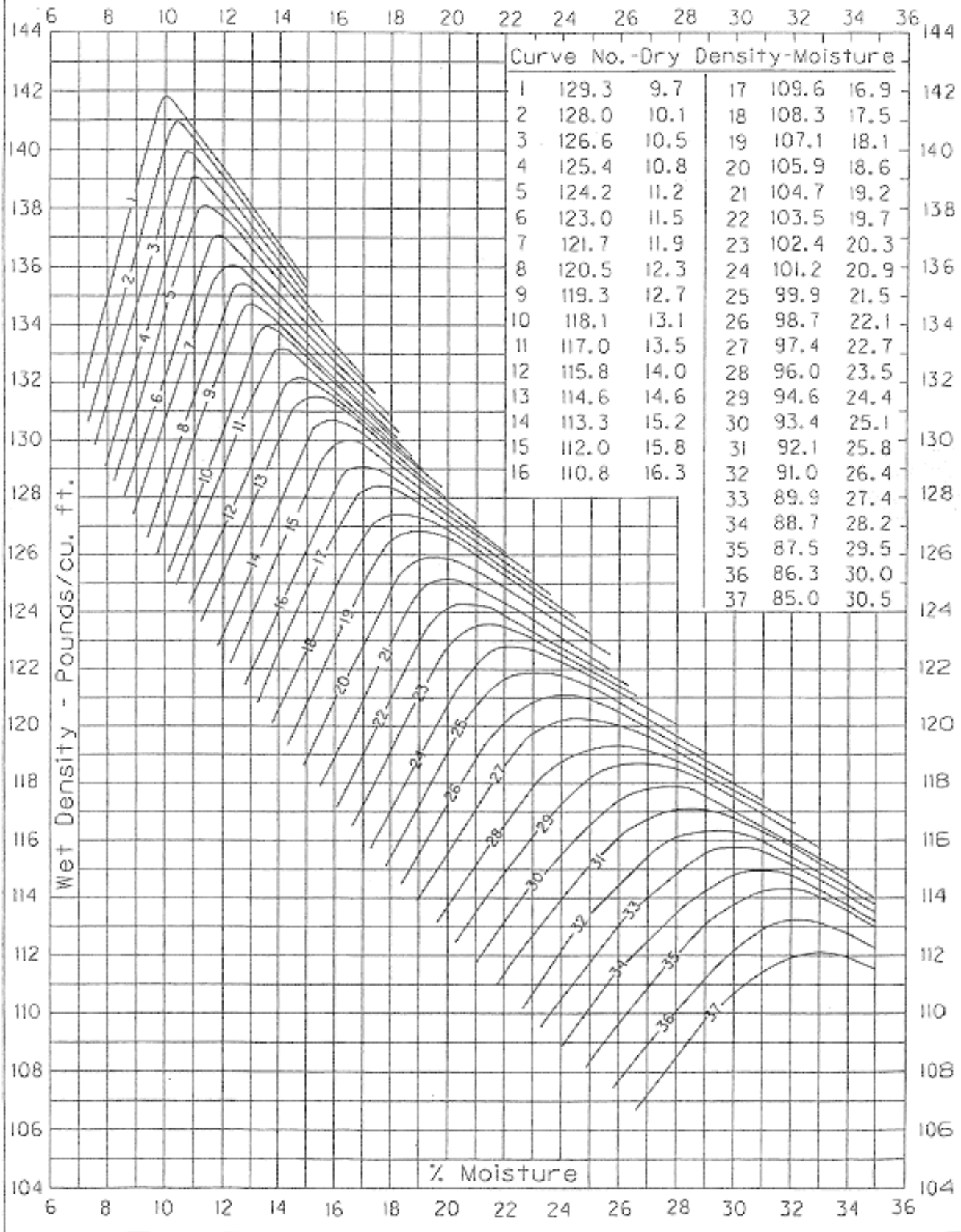

Kentucky Transportation Cabinet
Department of Highways
Division of Materials, Geotechnical Branch
One Point Procter Data Sheet

COUNTY: _____ PROJECT NUMBER: _____
 STATION: _____

Sieve Analysis

Wt. of +4 Material _____ (A)
 Wet Wt. of -4 Material _____ (B)

One-Point Procter on -4 Material

Wt. of Compacted Sample and Mold _____ (D)
 - Weight of Mold _____ (E)
 = Wet Wt. of Compacted Sample _____
 x Mold Factor (0.06614 if not on Mold) _____
 = Wet Density of Compacted Sample _____ (F)

Speedy Moisture _____ % (M)

From Family of Curves:

Maximum Dry Density (PCF) _____ (G)
 Optimum Moisture (%) _____ (I)

Percent of +4 Material

Wet Wt. of -4 Field Sample _____ (B)
 ÷ Dry Wt. Factor: $X=1+(M/100)$ _____ (X)
 = Dry Wt. -4 Field Sample _____ (Y)

Percent Coarse Particles: _____ (A)
 ÷ _____ (A+Y)
 x 100 _____
 = _____ % (C)

If C > 5% then Adjust Density and Moisture for +4 Material

Moisture Adjustment: _____ (I)
 x _____ $1-(C:100)$
 + _____ (C:50)
 = _____ (J)

Optimum Moisture of
 Total Sample (J) = _____ %
 Maximum Dry Density
 of Total Sample (H) = _____ PCF

Density Correction Chart for Coarse Particles

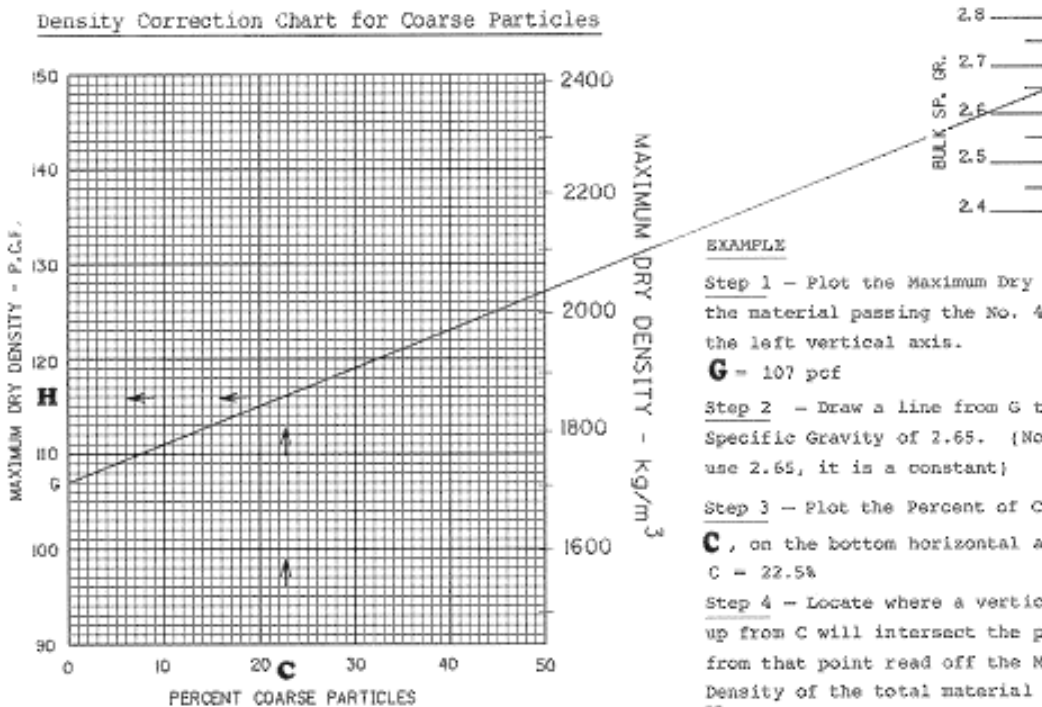

EXAMPLE

Step 1 - Plot the Maximum Dry Density of the material passing the No. 4 sieve, G, on the left vertical axis.

G = 107 pcf

Step 2 - Draw a line from G to the Bulk Specific Gravity of 2.65. (Note: Always use 2.65, it is a constant)

Step 3 - Plot the Percent of Coarse Particles, C, on the bottom horizontal axis.

C = 22.5%

Step 4 - Locate where a vertical line traced up from C will intersect the plotted line, and from that point read off the Maximum Dry Density of the total material (H).

H = 116 pcf

DETERMINATION OF SLAKE DURABILITY INDEX

1. SCOPE: The test procedures are intended to assess the resistance to weathering of rock samples after being subjected to two standard cycles of drying and wetting. The basis for the test is that weakly cemented or compacted argillaceous materials absorb moisture when subjected to a simulated weathering process. Moisture absorption by the soil-like rock may cause disaggregation in the form of powdering, spalling, or flaking of the sample surface, or separations along bedding planes.
2. APPARATUS:
 - 2.1. Slake durability testing machine.
 - 2.1.1. A test drum comprised of a 2.00 mm standard mesh cylinder of unobstructed length 100 mm and diameter 140 mm, with solid fixed base. The drum has a solid removable lid. The drum must be sufficiently strong to retain its shape during use, but neither the exterior of the mesh nor the interior of the drum should be obstructed, for example by reinforcing members.
 - 2.1.2. A trough, to contain the test drum supported with axis horizontal in a manner allowing free rotation, capable of being filled with water to a level 20 mm below the drum axis. The drum is mounted to allow 40 mm unobstructed clearance between the trough and the base of the mesh. The principal feature of the trough and drum assembly are illustrated below.
 - 2.1.3. A motor drive capable of rotating the drum at a speed of 20 rpm, the speed must be held constant to within 5 per cent for a period of 10 minutes.
 - 2.2. An oven capable of maintaining a temperature of $230^{\circ} \pm 9^{\circ}\text{F}$ for a period of at least 12 hours.
 - 2.3. A balance of suitable capacity capable of weighing to an accuracy of 1.0 grams.
 - 2.4. Beakers of at least 500 milliliter capacity.
3. PROCEDURE:
 - 3.1. Number and weigh beakers. (weight of beaker = B)
 - 3.2. Select samples and place them in numbered beakers. Use 10 pieces of material in each beaker. Each piece should weigh approximately 40 - 50 grams. The total sample should weigh approximately 450 - 550 grams.
 - 3.3. Oven dry sample for at least 12 hours.

- 3.4. Weigh and record the weight of the sample plus beaker (W_1).
 - 3.5. Place the oven dried sample in the test drum and mount in the trough. Adjust water level in the trough to 20 mm below the horizontal drum axis and rotate the drum at 20 revolutions per minute for 10 minutes.
 - 3.6. Remove the sample from the drum and repeat steps 3.3 and 3.5.
 - 3.7. Remove the sample from the drum and repeat step 3.3.
 - 3.8. Weigh and record the weight of the sample plus beaker (W_2).
4. CALCULATION: The slake durability index is calculated as the percentage ratio of final to initial dry sample weights as follows:

$$\text{Slake Durability Index (SDI)} = \frac{W_2 - B}{W_1 - B} \times 100$$

5. REPORT: The report should include the following information for each sample tested:
- 5.1. The slake durability index (second cycle) to the nearest 0.1 percent.
 - 5.2. The appearance of fragments retained in the drum.

APPROVED

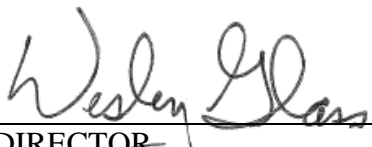

 DIRECTOR
 DIVISION OF MATERIALS

DATE

02/26/08

Kentucky Method 64-513-08
 Revised 02/26/08
 Supersedes KM 64-513-02
 Dated 11/19/02

JAR SLAKE TEST

1. SCOPE: The test is intended to assess the resistance to weathering of rock samples by a simple and quick procedure. The basis for the test is that weakly cemented or compacted argillaceous materials absorb moisture when subjected to a very basic, simulated weathering process. This procedure supplements the Slake Durability Index (SDI) test.
2. APPARATUS:
 - 2.1. Drying oven capable of maintaining a temperature of $230^0 \pm 9^0$ F.
 - 2.2. Beakers of at least 250 milliliter capacity.
 - 2.3. Distilled water or tap water.
3. PROCEDURE:
 - 3.1. Oven dry an approximately 50 gram sample of material for at least 6 hours, then let it cool for 30 minutes at room temperature.
 - 3.2. Immerse the sample in a beaker of distilled or tap water at least one half inch below the surface.
 - 3.3. Observe at frequent intervals for the first half hour noting the time with each observation; then at intervals thereafter for 24 hours.
4. REPORT: Jar slake values shall be reported according to the following criteria:

<u>Category</u>	<u>Behavior</u>
1.	Degrades to pile of flakes or mud (Complete Breakdown).
2.	Breaks rapidly and/or forms many chips.
3.	Breaks slowly and/or forms many chips.
4.	Breaks rapidly and/or develops several fractures.
5.	Breaks slowly and/or develops few fractures.
6.	No change.

APPROVED

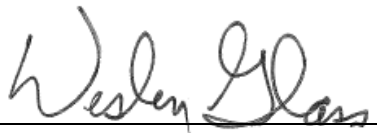

DIRECTOR
DIVISION OF MATERIALS

DATE

02/26/08

Kentucky Method 64-514-08

Revised 02/26/08

Supersedes KM 64-514-02

Dated 11/15/02

Kentucky Method 64-519-08
Revised 04/01/08
Supersedes KM 64-519-02
Dated 11/15/02

PARTICLE SIZE ANALYSIS OF SOILS
(HYDROMETER TEST)

Refer to *Standard Method Of Test For Particle Size Analysis - AASHTO T88 – 00 (2004)* with the following exception:

paragraph 12.2: the 5, 15, and 30 minute readings are not taken.

APPROVED

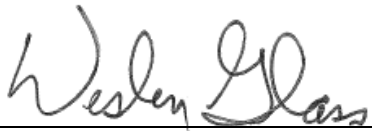

DIRECTOR
DIVISION OF MATERIALS

DATE

04/01/08

Kentucky Method 64-519-08
Revised 04/01/08
Supersedes KM 64-519-02
Dated 11/15/02

SUBGRADE CHEMICAL STABILIZATION TEST

1. SCOPE: The following test method shall be used to determine the percent chemical that will be added to a soil subgrade for stabilization. The type chemical (cement or lime) will be determined in accordance with Federal Highway's manual FHWA-IP-80-2, "Soil Stabilization in Pavement Structures-A User's Manual".
2. MOISTURE-DENSITY:
 - 2.1. A minimum of 2 moisture-density tests shall be performed on each sample. One test shall be performed on the natural soil and another with 5 percent chemical added based on dry weight.
 - 2.2. The test shall be performed in accordance with [Kentucky Method KM 64-511](#) with the following additions:
 - 2.2.1. Add to the soil for test no. 2 the required amount of chemical prior to adding water and mix thoroughly to a uniform color.
 - 2.2.2. When the test is performed with a lime additive, the sample shall be allowed to mellow for one hour in a covered pan after adding water prior to compaction.
3. UNCONFINED COMPRESSION:
 - 3.1. Apparatus:
 - 3.1.1. Specimen molds: The molds shall be cylindrical in shape and made of rigid metal with a inside diameter of 2.80 ± 0.01 in. The height-to-diameter ratio shall be between 2 and 2.5. Refer to Figures 1 and 2 for details of the compaction equipment.
 - 3.1.2. Balance: A balance that has a 0.1 g. readability.
 - 3.1.3. Oven: A thermostatically controlled drying oven capable of maintaining a temperature of $230^{\circ} \pm 9^{\circ}\text{F}$ for drying moisture samples and $120^{\circ} \pm 9^{\circ}\text{F}$ for curing samples.
 - 3.1.4. Mixing Tools: Mixing pans, spoons, trowels, etc. and a device for measuring increments of water.
 - 3.2. Sample Preparation: Samples shall be compacted for unconfined compression testing with varying percentages of chemical additive. Four samples are recommended for lime (0,4,5 and 6%) and 3 for cement (0,4, and 6%). The samples shall be compacted at 95% of maximum density and at optimum moisture. The density test with 5% additive shall be used for all samples for preparing test specimens for unconfined testing. Samples shall be

prepared as follows:

- 3.2.1. One specimen shall be prepared for each percentage. Prepare a predetermined weight of the uniformly mixed soil or soil-chemical to provide a specimen of the designed density. When using lime the mixture shall mellow for one hour prior to compacting in the mold.
- 3.2.2. The mixture shall be compacted in the mold in four equal layers by tapping the piston with a rubber mallet. One sleeve shall be added to the piston for each layer.
- 3.2.3. The sample shall be removed from the mold and weighed. Unconfined compression tests shall be performed on untreated samples after weighing. Treated samples shall be placed in a sealed plastic bag. This bag is placed in another bag, approximately 3 ounces of water added for a moisture barrier, sealed, and placed in an oven at $120^{\circ}\text{F} \pm 9^{\circ}\text{F}$. The sample is cured for 48 hours and then tested.
- 3.2.4. Unconfined Compression tests shall be in accordance with AASHTO T-208.

4. CALCULATION: When the unconfined compressive strengths have been determined a plot shall be made of Q_u (psi) verses percent chemical.
5. REPORT: The recommended percentage of chemical shall be determined and reported as follows:
 - 5.1. The percentage at which a 50 psi increase occurs above the untreated soil strength, but with a unconfined compressive strength not less than 100 psi.
 - 5.2. The percentage at which the peak strength occurs when 5.1.1 is not obtained.

APPROVED

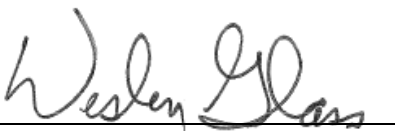

DIRECTOR
DIVISION OF MATERIALS

DATE

02/26/08

Kentucky Method 64-520-08
Revised 02/26/08
Supersedes KM 64-520-02
Dated 11/18/02

Kentucky Method 64-521-08
Revised 04/01/08
Supersedes KM 64-521-02
Dated 11/18/02

UNCONSOLIDATED, UNDRAINED COMPRESSIVE STRENGTH OF
COHESIVE SOILS IN TRIAXIAL COMPRESSION

Refer to *Standard Method Of Test For Unconsolidated, Undrained Compressive Strength Of Cohesive Soils In Triaxial Compression - AASHTO T 296-05* with the following additions and modifications:

Pocket penetrometer and/or Torvane tests shall be performed on each sample prior to testing and the results shall be recorded on the data sheets. For Torvane tests, the size of the vane used shall be indicated. These tests shall be performed on a portion of the sample that will be removed during the sample trimming process.

3.2.1: Failure shall be taken to correspond to the maximum principal stress difference (maximum deviator stress) attained or the principal stress difference (maximum deviator stress) at 15 percent axial strain.

7.1.3: Omit.

8.1.5: Values of load and deformation may be recorded at intervals of 30 seconds.

10.1: Calculation of the volume of solids, initial void ratio, and initial degree of saturation may be omitted.

10.4.3 & 10.4.4: Omit.

10.4.4.1: Calculation of the initial degree of saturation may be omitted.

11.1.2 to 11.1.4: May be omitted if presented on other data sheets or in other reports.

11.1.5: Void ratio and percent saturation may be omitted.

11.1.8: Replace "and the values of the effective minor and major principal stresses at failure" with "shall be reported as the undrained compressive strength, U_u ."

APPROVED

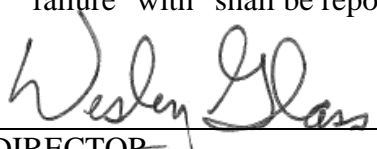

DIRECTOR
DIVISION OF MATERIALS

DATE

04/01/08

Kentucky Method 64-521-08
Revised 04/01/08
Supersedes KM 64-521-02
Dated 11/18/02

KM 64-521-08

Kentucky Method 64-522-08
Revised 04/01/08
Supersedes KM 64-522-02
Dated 11/14/02

UNCONFINED COMPRESSION TEST ON SOIL

REFER TO STANDARD METHOD OF TEST FOR UNCONFINED COMPRESSIVE STRENGTH OF COHESIVE SOIL - AASHTO T 208-05 WITH THE FOLLOWING ADDITIONS:

Pocket penetrometer and/or Torvane tests shall be performed on each sample prior to testing and the results shall be recorded on the data sheets. For Torvane tests, the size of the vane used shall be indicated. These tests shall be performed on a portion of the sample that will be removed during the sample trimming process.

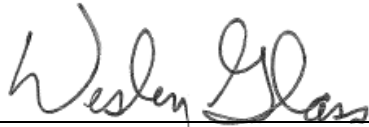
APPROVED 

DIRECTOR
DIVISION OF MATERIALS

DATE 04/01/08

Kentucky Method 64-522-08
Revised 04/01/08
Supersedes KM 64-522-02
Dated 11/14/02

UNCONFINED COMPRESSION TEST ON ROCK

1. SCOPE: This method describes the procedures employed in preparing and testing rock core specimens with diameters of approximately 2 in. to determine their Unconfined Compressive Strength.
2. Refer to *Standard Practice For Preparing Rock Core Specimens And Determining Dimensional And Shape Tolerances - ASTM D 4543-08* with the following modifications:
 - 7.5 to 7.7: Specimens may be capped with unbonded caps meeting the requirements of ASTM C 1231 (6.2 & 6.3) except that the retainers shall have inside diameters of 2.20 ± 0.05 in. Qualification tests are not necessary to establish the maximum and minimum strength levels appropriate for use with pads of a given Shore A durometer hardness of pads; Shore A durometer hardnesses of 50 to 70 are recommended.
 - 9.1 to 9.6 may be omitted if specimens meet the following shape tolerances:

Each surface of the specimens shall be plane within 0.25 in., i.e. there shall be no depressions or protrusions in the surface that are greater than 0.25 in. Neither end of the specimens shall depart from perpendicularity by more than 0.05 in. in 2 in. or 2.5 parts in 100. The difference between the maximum and minimum specimen diameters shall not exceed 0.1 in.
 - 11.1 to 11.1.4: May be omitted if the information is presented in other project records.
 - 11.1.5 to 11.1.5.3: Verification that the specimen meets the specified shape tolerances may be reported.
 - 11.1.6: May be omitted if the information is presented in other project records.
3. Refer to *Standard Method for Compressive Strength and Elastic Moduli of Intact Rock Core Specimens Under Varying States of Stress and Temperatures - ASTM D 7012-07* with the following modifications:
 - 4.2: Add the following: Specimens shall be wrapped or otherwise preserved in the field to prevent loss of moisture.
 - 5: If specimens are capped with unbonded caps add the following:

Specimens shall be air dry on the surface immediately prior to testing to avoid the possibility of allowing moisture to get between the pads and retainers and then rusting.

Each pad shall have a light coat of talcum powder on the bearing surface prior to testing a specimen.

During testing, there shall be no loose particles of soil, dust, etc. trapped in the following locations: between the pads and the retainers; between the specimen and the pads; between the retainers and the bearing blocks of the testing machine.

Place a cap on the top and bottom surface of the specimen. With the caps in contact with the specimen, carefully align the axis of the specimen with the center of thrust of the spherically seated block. Bring the bearing blocks of the machine in contact with both of the caps.

If $1.8 \leq L/D < 2.0$, the Unconfined Compressive Strength may be calculated as follows:

$$q_u = \alpha \left(\frac{\text{Max. Load}}{\text{Area}} \right), \quad \text{where } \alpha = \left(\frac{1}{0.88 + \frac{0.24}{(L/D)}} \right)$$

8.1: Specimens may be prepared according to the procedures above.

11.1.2: May be omitted if the information is presented in other project records.

11.1.3: The moisture condition when the sample is received, and after specimen preparation, should be recorded. At a minimum, report the moisture condition qualitatively as as-received, saturated, laboratory air-dry, or oven-dry. The moisture condition may be determined more precisely and reported as water content using AASHTO T 265.

11.1.5 to 11.1.6 These sections are optional.

11.1.7: Alternatively, the time to failure may be reported.

11.1.9 to 11.1.12 These sections are optional.

APPROVED

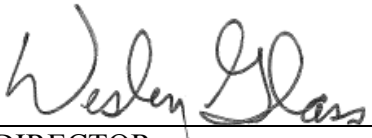

DIRECTOR
DIVISION OF MATERIALS

DATE

04/01/08

Kentucky Method 64-523-08
Revised 04/01/08
Supersedes KM 64-523-02
Dated 11/18/02

Kentucky Method 64-601-17
Dated 09/11/17
Supersedes KM 64-601-16
Dated 05/20/16

SAMPLING OF AGGREGATES FOR USE AS HIGHWAY MATERIALS

1. SCOPE:

- 1.1. This method applies to the sampling of coarse and fine aggregates for preliminary investigation of the potential source of supply, control of the product at the source, control of operations at the site of use, and acceptance or rejection of the material.
- 1.2. Although this method has been written around state practices, AASHTO T2 and ASTM D75 were used as references.

2. APPARATUS:

- 2.1. The aggregate producer, supplier, or contractor is to provide suitable sampling equipment and assistance at the location.
- 2.2. A square point shovel shall be used to collect samples.
- 2.3. Sand Tube – Tube or pipe may be used to sample damp fine natural sand.
- 2.4. Miscellaneous: sample containers, brush and dust pan, metal or plywood shield
- 2.5. Other equipment that should be used when available and is applicable:
 - 2.5.1. Templates designed to fit the curvature of the conveyor belt when performing belt cut sampling.
 - 2.5.2. Loader or special sampling equipment for flowing aggregate discharge sampling.
 - 2.5.3. When sampling larger aggregates that are not easily shoveled, as in the case of 4's or larger, a template may be used to sample in place of a shovel.

3. SAMPLE SIZE:

- 3.1. The following table defines the minimum sample size based on the Nominal Maximum Size of Aggregate being sampled. The nominal maximum size of the aggregate is the largest sieve size listed in the applicable specification upon which any material is permitted to be retained. When nominal maximum size cannot be determined by the applicable specification, a preliminary examination of the material must be performed to determine the largest particle size present.

Nominal Maximum Size of Aggregate in inches	Minimum Mass of Field Sample in pounds
$\frac{3}{8}$ or smaller	10
$\frac{1}{2}$	20
$\frac{3}{4}$	30
1	50
1 $\frac{1}{2}$	70
2	90
3	125
3 $\frac{1}{2}$ or larger	150

4. PROCEDURE:

4.1. Sampling is equally as important as testing. The sampler shall use every precaution to obtain samples that will display the true nature and condition of the material which they represent.

4.2. Unless otherwise authorized, all acceptance samples shall be taken by a department representative at the last practical point for acceptance testing at the following locations:

- Roadway for CSB and DGA samples
- Concrete plant for concrete aggregate
- Asphalt plant for asphalt aggregate samples

Note: If asphalt mix roadway samples are to be taken, the asphalt mix shall be sampled from the asphalt paver on the project site. The corresponding virgin polish resistant aggregate shall be sampled at the asphalt plant.

4.3. Prior to securing the samples, material shall be visually inspected to check for non-conformity within the lot. When non-uniformity is noted, re-blend before sampling or obtain additional samples so the material will be truly represented.

4.4. The test sample shall be a composite from a minimum of 3 locations in the lot.

4.5. Sampling from Conveyor Belts (Coarse and Fine Aggregate)

4.5.1. Collect aggregate samples from conveyor belts when the belt is stationary. When available, insert two templates shaped to the curvature of the belt into the aggregate stream spaced so the material contained between them will yield approximately 1/3 of the size sample required.

Note: The templates must be held firmly in place during the sampling to prevent intrusion of materials from either side of the sample zone.

- 4.5.2. Carefully scoop all material between the templates into a suitable container. Collect loose fines on the belt with a brush and dust pan and add them to the container. A minimum of 3 belt cut sample increments shall be taken from the belt per composite sample.

Note: Properly maintained automatic belt samplers may be used. Regular inspection ensures all material is being removed from the belt.



Automatic Belt Sampler

- 4.6. Sampling from a flowing Aggregate Discharge (Belt or Bins) – (Coarse and Fine Aggregate)
- 4.6.1. It is usually necessary to have a special device constructed for use at each plant. This device shall consist of a pan of sufficient size to intercept the entire cross section of the discharge stream and to hold a practical amount of material without overflowing. A set of rails may be necessary to support the pan as it is passed under the discharge stream. A loader bucket large enough to catch the entire flow of aggregate may be used.

- 4.6.2. Obtain samples from the entire cross-section of the flow of material as it is being discharged. Do not sample the first flow from a conveyor, newly charged bin, or nearly empty bin as these may produce erroneous results.

A minimum of 3 portions shall be taken from the flow and then be mixed by the loader to make a miniature flattop stockpile.

4.7. Sampling from Cold Feed Bins at Asphalt Plants

- 4.7.1. When prudent, a large pan may be passed under the bins on the conveyor belt leading to the mixing plant. The pan must be large enough to catch material without overflowing and small enough to pass under all bins without interfering with plant operations.

4.8. Sampling from Bituminous Plant Hot Bins

- 4.8.1. When samples of aggregates are withdrawn from bituminous plant hot bins, samples from each bin may be combined in the same percentages used to produce the bituminous mixture.

4.9. Sampling from Stockpiles

- 4.9.1. Stockpile sampling methods vary depending on the type of aggregate and the method used in stockpile construction. When sampling for gradation purposes, avoid sampling from stockpiles when another location is practical and acceptable. The interior of a stockpile cannot be sampled without removal of material at the sampling points; therefore, it is desirable to sample stockpiles as they are built or as material is removed.

4.10. Sampling a Stockpile of Coarse Aggregate (Nominal Maximum Size 3/8 in. or Larger)

- 4.10.1. Select a minimum of 3 areas located along a line from the base to the top of the pile. At approximately even intervals along this line, prepare a sampling bench by clearing away as much of the material at the surface as practicable.
- 4.10.2. Place a shield against the material above the sampling bench to prevent the flow of aggregate into the sampling area. The shield may be any convenient material such as corrugated metal, plywood, etc.
- 4.10.3. Insert the shovel as far as possible into the material exposed by the bench, remove a full shovel portion, and place it in a suitable sample container. Do not drop material from the shovel when moving toward sample container. Repeat this procedure at each of the locations until a composite sample of the required minimum size is obtained.

Note: When available, mechanical equipment should be used to obtain material from as far inside the stockpile as possible.

- 4.10.4. Use a loader to dig as far inside the production stockpile as possible at a minimum of 3 locations. Blend removed material into a miniature stockpile and strike off the top 1/3 to 1/2 of the pile to create a flattop miniature stockpile. Collect at least 3 increments from the miniature stockpile to comprise a composite field sample. **This is the most preferred way to sample for source prequalification testing which will be performed by the Central Office Division of Materials Aggregate Section.** (See pictures below.)



4.11. Sampling a Stockpile of Fine Aggregate (Nominal Maximum Size Less than 3/8 in.)

4.11.1. Samples of fine aggregate should be taken in the same general manner as coarse aggregate; however, the number of sampling locations may be less for damp fine aggregate. Additionally, surface material should be removed before taking the sample.

4.11.2. A sampling tube may be used to sample damp natural sand. Remove the outer layer of the sampling area, insert the sand sampling tube into the stockpile, withdraw the tube containing the sample increment, and empty into a suitable container.



Using a Sand Tube for Natural Sand

4.12. Sampling Coarse Aggregate that is not easily shoveled, as in the case of 4's and larger

4.12.1. Place a template on the flat surface of aggregate. Pick up all particles within the template down to about the level of where a shovel would reach, and place the particles in a sample container.

4.12.2. Perform 4.12.1. at least 3 times to comprise the field sample (see picture below).



Template used to sample larger aggregate that is not easily shoveled

4.13. Sampling from Trucks, Barges, and Railroad Cars (Coarse and Fine Aggregate)

4.13.1. Procedures for sampling trucks, barges, and railroad cars are similar to those used for flattop stockpiles. Select at least 3 approximately even spaced locations representing the entire length of the transport vehicle. Samples should not be taken from near the sides or ends of the transport vehicle.

4.13.2. At each of these locations, a portion should be removed from a depth of not less than 1 ft. below the surface. Materials from the sides of the sample hole or area should be prevented from entering the sample area. Each of these sample portions should be placed in a suitable sample container and the combination should yield a sample of the required minimum size.

4.14. Sampling Aggregate for Compacted Base

4.14.1. When taking samples of aggregates for compacted bases (DGA, CSB, etc.), sample at the last practical point. When a spreader box or paver is used, this point is defined as the roadway after spreading but before compaction.

4.14.2. To sample the roadway after spreading but before compaction, the sampler shall choose an area between the spreader and compaction equipment that will yield a minimum of 3 sampling points on a diagonal across the roadway. Remove material from each sampling point without digging into the underlying subgrade. Avoid the tracks left by equipment (see picture below). Place sample in a suitable container.



Note: If use of a spreader box or paver is not practical or the area covered is very thin and narrow (shoulder) and the engineer determines representative samples cannot be obtained from the roadway, an alternate acceptance point shall be determined by the engineer. The alternate acceptance point shall be on the jobsite at a point which best represents the base aggregate.

5. SHIPPING SAMPLES:

- 5.1. Transport samples in tied plastic bags or 5 gallon buckets with lids so that no loss of material or contamination occurs. Attach information to the sample including the sample ID, location, date sample was taken, producer name and source number, aggregate size, and any other information deemed necessary. If multiple containers are used for one sample, attach all information to each container.
- 5.2. Aggregate samples for Quality Testing (Soundness and Wear) are sent to the Central Office Division of Materials and should consist of one bag (less than 70 lbs.) for size 57's or smaller. A verification bag for coarse aggregate should be kept at the District Materials Lab or sent to the Central Office Division of Materials.

APPROVED

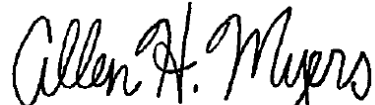

DIRECTOR
DIVISION OF MATERIALS

DATE

09/11/17

Kentucky Method 64-601-17

Dated 09/11/17

Supersedes KM 64-601-16

Dated 05/20/16

DETERMINATION OF THE PERCENTAGE OF SHALE IN AGGREGATE

1. **SCOPE:** This test method describes a procedure for determining the percentage by mass of shale in the plus 1/4 in. or plus 3/8 in. portion of aggregates. Shale is defined to be a fissile rock that is formed by the consolidation of clay, mud or silt, typically has a finely stratified or laminated structure, and is composed of minerals essentially unaltered since deposition.
2. **APPARATUS:**
 - 2.1. **Balance:** The balance or scale shall be sensitive to within 0.1 percent of the mass of the sample to be tested except that graduations less than 1 gram will not be required.
 - 2.2. **Sieves:** A 3/8 in. and a 1/4 in. sieve conforming to AASHTO M 92.
 - 2.3. **Miscellaneous:** Equipment suitable for washing, drying and storage of aggregates (buckets, pans, spatula, cloth, etc.).
 - 2.4. **Other equipment, which should be used when available, shall consist of the following:**
 - 2.4.1. **Mechanical Shaker:** For separation of the aggregate over the 1/4 in. sieve or 3/8 in. sieve.
 - 2.4.2. **Sample Splitter:** A sample splitter for the reduction of large samples.
3. **SAMPLE:**
 - 3.1. **Field samples shall be obtained in accordance with KM 64-601.**
 - 3.2. **The minimum field sample mass and the mass of the damp test portion are listed in the following table. The sample shall be reduced in size by splitting or quartering, as applicable, in accordance with KM 64-632. The test portion is obtained by washing the reduced sample over a 1/4 in. sieve for sizes No. 78, No. 8, No. 9-M, and fine aggregate. All other coarse aggregate sizes are washed over a 3/8 in. sieve. The material retained on the sieve is used for testing. (See PRECAUTIONS [Section 6](#))**

NOMINAL MAXIMUM SIZE	MINIMUM MASS OF FIELD SAMPLE	MINIMUM MASS OF TEST PORTION
3/8 in. or less	10 lb.	500 grams
1/2 in.	20 lb.	1500 grams
3/4 in.	30 lb.	2500 grams
1 in. to 1 ½ in.	60 lb.	3000 grams
1 ¾ in. to 3 ½ in	80 lb.	9000 grams

4. PROCEDURE:

- 4.1. Spread the wet portion on a sufficient area of work bench so that the individual particles may be carefully inspected. The work bench should be covered with Kraft paper or similar material to prevent loss of aggregate particles.
- 4.2. Use the fingers or a spatula and visually classify the test portion into two separate piles as either shale or non-shale aggregate.

Note: Maintaining the material in a damp condition will aid in visually classifying and separating shale from the test portion, as shale will generally dry more slowly and thus should appear darker than the other particles.

- 4.2.1. Shale will be identified by one or more of the following characteristics: (1) easily broken or deformed between the fingers (2) splits easily along laminations (3) has a slick or greasy feel when wet. Material from the Waldren, Eden, New Albany or other similar shale formations will count as shale.
- 4.2.2. Do not randomly pick the shale out of the test portion, but systematically handle each particle of aggregate and place it in its respective classified pile.

NOTE: The test portion may be soaked in water for 24 hours before testing, when deemed appropriate by the tester. (See PRECAUTIONS – [Section 6](#))

- 4.3. Surface dry each pile of aggregate by the use of a cloth, or other acceptable means, and weigh separately to the nearest gram, recording the mass of shale as W_s and the mass of non-shale aggregate as W_g .

5. CALCULATIONS:

5.1. Calculate the percentage of shale as follows:

$$\text{Percent of Shale} = \frac{W_s}{W_s + W_g} \times 100$$

Where:

W_s = mass of shale

W_g = mass of non-shale aggregate

6. PRECAUTIONS: Some soft shale will break up easily when exposed to water, when this occurs it will be necessary to dry sieve the sample first, then pick out the soft shale. The sample can then be washed and further checked for additional shale.

7. REPORT:

7.1. Report the results to the nearest 0.1 of a percent.

7.2. The Division of Materials will be the final authority in all disputes involving shale content determinations.

7.3. When test results are obtained that do not fall within specification limits, the failure must be verified. The unused field sample is to be tested in the same manner as the original test sample. When the original and the verification test results are reasonably close they are to be averaged to obtain a single reportable test result. When the two test results vary considerably further investigation will be necessary. Investigation may include checking test equipment, reducing field sample to test sample practices, methods of calculations and/or obtaining an additional field sample to test.

APPROVED

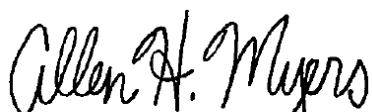

DIRECTOR
DIVISION OF MATERIALS

DATE

11/03/16

Kentucky Method 64-604-16

Revised 11/03/16

Supersedes KM 64-604-14

Dated 08/04/14

SPECIFIC GRAVITY AND ABSORPTION OF FINE AGGREGATE

1. SCOPE

- 1.1. This method covers the determination of bulk specific gravity (saturated surface-dry basis), bulk specific gravity (oven-dry basis), apparent specific gravity, and absorption of fine aggregate.

2. APPARATUS

- 2.1. Balance – A balance of sufficient capacity, readable to 0.1 gram or better and conforming to the requirements of AASHTO M231.
- 2.2. Pycnometer – A glass quart mason jar equipped with a threaded pycnometer top. The jar and top shall be threaded such as to provide a water-tight connection.
- 2.3. Mold – A metal mold in the shape of a cone with dimensions as follows: 40 ± 3 mm inside diameter at the top, 90 ± 3 mm inside diameter at the bottom, and 75 ± 3 mm in height, with the metal having a minimum thickness of 0.8 mm.
- 2.4. Tamper – A metal tamper weighing 340 ± 15 grams and having a flat circular tamping face 25 ± 3 mm in diameter.
- 2.5. Sample splitter
- 2.6. Drying pans
- 2.7. Oven – An oven capable of maintaining a temperature of $230 \pm 9^\circ\text{F}$.
- 2.8. Sieve – A No. 200 sieve conforming to AASHTO M92. A larger sieve size may be used to protect the No. 200.
- 2.9. Gilson SS-28 Vibra Pad
- 2.10. Fan to provide a gentle current of air. Speed of fan should be slow enough as to not cause loss of fines.

3. DEFINITIONS

- 3.1. Constant Mass – The sample has reached a constant mass when an additional 30 minutes of drying at the specified temperature causes 0.1 percent or less decrease in mass.

- 3.2. Saturated Surface-Dry Condition – Proper SSD condition has been achieved when a small amount of material about the diameter of a dime remains standing in the center of the pile after the cone has been removed. [See Pictures 1 and 2.](#)

4. SAMPLES

- 4.1. Obtain field samples in accordance with AASHTO T2.
- 4.2. Obtain a test portion of approximately 2000 grams of the fine aggregate from the field sample by use of a sample splitter, by quartering, or by miniature stockpile sampling as applicable and in accordance with AASHTO T248.
- 4.3. Wash the sample over the No. 200 sieve.
- 4.4. Remove the material from the sieve and oven dry to a constant mass and cool to a comfortable handling temperature.
- 4.5. Cover the sample with water in a container and soak for 15 to 24 hours.
- 4.6. Decant excess water over a No. 200 sieve and spread the test portion on a flat, non-absorbent surface exposed to a gently moving current of air. **Stir frequently to secure uniform drying.**
- 4.7. Hold the mold firmly on a smooth non-absorbent surface with the large diameter down. Fill the mold until overflowing occurs.
- 4.8. Lightly tamp the surface of the material 25 times with the tamper. Adjust the height and position of the tamper above the sand surface as necessary, so that a drop of 5mm (0.2 in.) is used throughout the tamping process and is distributed over the surface of the aggregate. Do not hit or shake the cone while checking for SSD condition. (During each check of SSD condition, the fan should be off.)
- 4.9. Remove loose sand from outside the base and lift the mold vertically away from the material. If surface moisture is still present, the fine aggregate will retain the molded shape. Continue drying and stirring the material and test at frequent intervals until the tamped fine aggregate reaches SSD condition. Proper SSD condition has been achieved when a small amount of material about the diameter of a dime remains standing in the center of the pile after the cone has been removed. [See Pictures 1 and 2.](#) If material will not retain molded shape and surface moisture is still visible. SSD determination will be as defined in [Subsection 7.2.](#)
- 4.10. If sample is taken past SSD condition then return to 4.5 and continue the test.

5. PROCEDURE

- 5.1. Make and record all mass determinations to 0.1 gram.
- 5.2. Immediately introduce 500.0 grams (record as “S”) into the jar half filled with water and a second 500.0 gram portion into a pan to be placed into an oven. Fill jar with additional

water to approximately 90 percent of capacity. Put the pycnometer top onto the jar and place the jar onto a Gilson SS-28 Vibra Pad for 4 minutes at high setting. Finish filling the pycnometer with water (top off with a bead of water), dry any water from the sides of the pycnometer, and weigh the pycnometer filled with fine aggregate and water to the nearest 0.1 gram. Record as "C".

- 5.3. Empty and discard all material from the pycnometer and completely fill the pycnometer with water (top off with a bead of water) and weigh the pycnometer filled with water to the nearest 0.1 gram. Record as "B".
- 5.4. Place second 500.0 gram portion from 5.2 into an oven at 230 ± 9 °F. After second portion has been dried to a constant mass and cooled, record this mass to the nearest 0.1 gram. Record as "A".

6. CALCULATIONS

6.1
$$\text{Bulk (SSD) Specific Gravity} = \frac{S}{B + S - C}$$

6.2
$$\text{Bulk (BOD) Oven Dry Specific Gravity} = \frac{A}{B + S - C}$$

6.3
$$\text{Apparent (APP) Specific Gravity} = \frac{A}{A + B - C}$$

6.4
$$\text{Absorption, percent (ABS)} = \frac{S - A}{A} \times 100$$

Where:

- A = Mass of oven dried material.
- B = Mass of pycnometer filled to capacity with water.
- C = Mass of pycnometer filled to capacity with fine aggregate and water.
- S = Mass of saturated surface-dry specimen.

7. PRECAUTIONS

- 7.1. The water used must be maintained at 73 ± 3 °F during the entire test.
- 7.2. Use the following on materials that will not retain molded shape when surface moisture is still visible after attempting Subsections 4.7 through 4.9:

For reaching the saturated surface-dry condition on materials that will not retain molded shape when surface moisture is still visible, hard-finish paper towels may be used to surface dry the material until the point is just reached where the paper towel does not appear to be picking up moisture from the surfaces of the aggregate particles. A new piece

of paper towel will be used for each check of SSD. Ecosoft Paper Towel number 46200 from Baywest is preferable.

8. REPORT

- 8.1. Report specific gravity to the nearest hundredth.
- 8.2. Report percent absorption to the nearest tenth of a percent.
- 8.3. When test results are obtained that fail to meet specification limits, a retest will be performed. The unused field sample is to be tested in the same manner as the original test sample. When the two test results vary considerably, further investigation will be necessary. Investigation may include checking test equipment, reducing field sample to test sample practices, methods of calculations and/or obtaining an additional field sample to test.

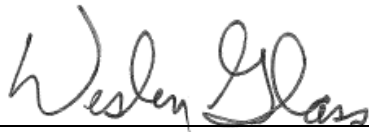
APPROVED 

DIRECTOR
DIVISION OF MATERIALS

DATE 02/21/08

Kentucky Method 64-605-08
Revised 02/21/08
Supersedes KM 64-605-06
Dated 05/08/06

Attachments

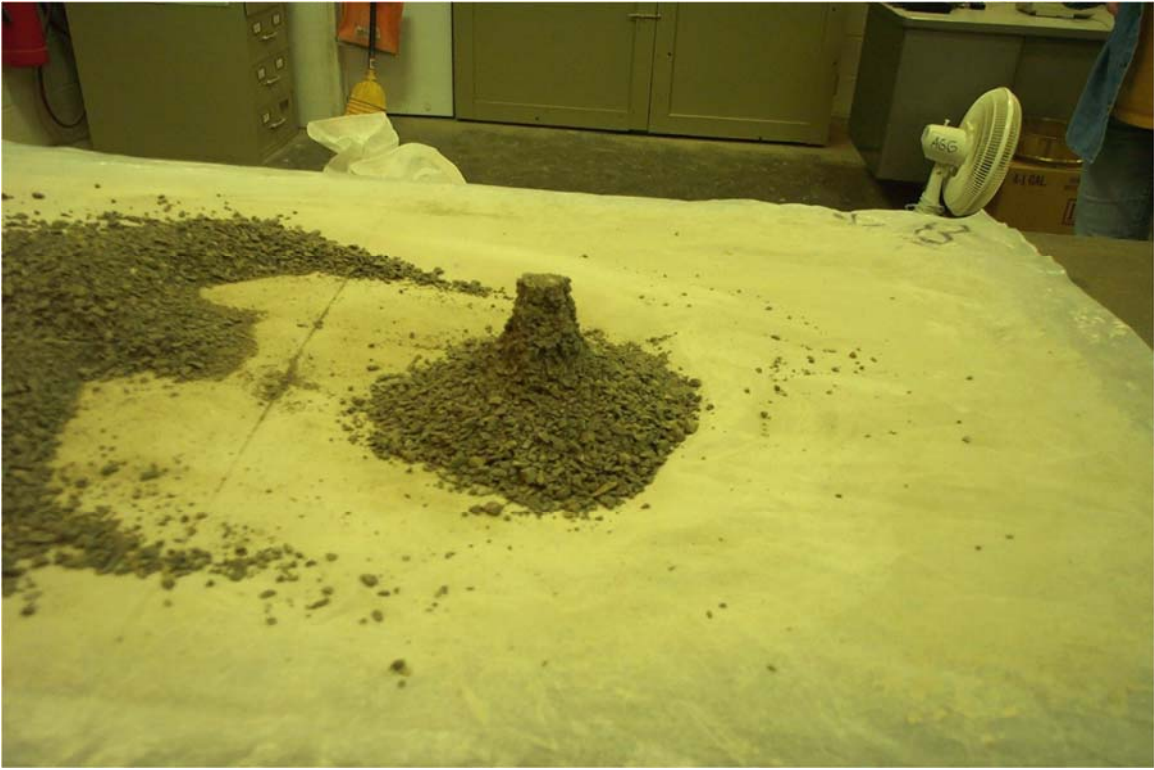

PICTURE 1



PICTURE 2

Kentucky Method 64-606-08
Revised 02/21/08
Supersedes KM 64-606-03
Dated 02/18/03

PERCENTAGE OF MATERIAL FINER THAN A NO. 200 SIEVE BY USE OF A PYCNOMETER
(WASH TEST)

1. SCOPE: This method is intended to provide a rapid test, which will yield results comparable to AASHTO T 11 for determining the amount of minus No. 200 sieve material in aggregates. Tests in accordance with AASHTO T 11 are acceptable alternates to this method.
2. APPARATUS:
 - 2.1. Sieves: A nest of two sieves, a No. 200 conforming to AASHTO M 92 and a protective sieve approximately No. 16.
 - 2.2. Balance: A balance capable of weighing at least 7000 grams, sensitive and accurate to 1 gram.
 - 2.3. Pycnometer: A plastic or glass jug with a capacity of approximately 1 gallon fitted with a pycnometer top threaded such as to provide a water-tight connection.
 - 2.4. Wetting Agent: Calgon powder is preferred.
 - 2.5. Funnel
 - 2.6. Towels
 - 2.7. Syringe
 - 2.8. Sample Splitter
 - 2.9. Container suitable for soaking aggregates.
3. SAMPLE:
 - 3.1. Field samples shall be obtained in accordance with AASHTO T 2.
 - 3.2. The minimum field sample mass and the mass of the test portion are listed in the following table. The sample shall be reduced in size by splitting or quartering, as applicable, in accordance with AASHTO T 248.

NOMINAL MAXIMUM SIZE	MINIMUM MASS OF FIELD SAMPLE	MINIMUM MASS OF TEST PORTION
No. 4 or less	10 lbs.	1000 grams
3/8 inch	10 lbs.	1500 grams
1/2 inch	20 lbs.	2500 grams
3/4 inch	30 lbs.	2500 grams
1 inch	50 lbs.	2500 grams
1 ½ inch	70 lbs.	3500 grams
2 inches	90 lbs.	5000 grams
2 ½ inches	125 lbs.	7000 grams

NOTE: If wet sieve analysis is desired, refer to [KM 64-620](#) for test portion mass & test method.

3.3. When the size of the test portion exceeds the capacity of the pycnometer (greater than approximately 3500 grams for most aggregates) the test portion shall be divided into as many equal parts by mass as necessary to insure against overfilling of the pycnometer. All of the divided parts shall be tested.

4. PROCEDURE:

- 4.1. The test portion, if not in saturated-surface dry condition or wetter at the time it is prepared for testing, shall be brought to a saturated condition by soaking in water for at least 30 minutes.
- 4.2. Introduce the test portion and soaking water, if used, into the pycnometer jar. Be very careful not to lose any fines. Fill the jar with water to about 80 to 90 percent of capacity.
- 4.3. Place the pycnometer top on the jar and roll the pycnometer to eliminate air bubbles. Take care to avoid any loss of material.
- 4.4. Complete filling the pycnometer with water, wipe all excess water from the outside of the pycnometer, place on a balance, top off the pycnometer to a bead, and determine the total mass of the pycnometer, sample, and water to the nearest gram. Record this mass as W_1 .

NOTE: Do not add wetting agent before this step is completed. Some aggregates may cause a foaming action during this step, which makes it difficult to form a water bead because of the entrapped air. An effective method to eliminate the entrapped air is to squeeze the jar to force foam out of the pycnometer top and soak up this overflow with a paper towel. Continue until all foam is removed from the pycnometer top.

- 4.5. Remove the pycnometer top and pour the free water over a No. 16 and a No. 200 sieve (nested in that order). Be careful not to let any water run out of the pycnometer without passing through the No. 16 and No. 200 sieves. Keep to a minimum the amount of larger particles that are decanted along with the water/fines mixture onto the sieves.
- 4.6. Refill the pycnometer to 80 to 90 percent capacity, add a small amount of wetting agent (Calgon) and replace the top. Be careful not to lose any sample or water, then thoroughly agitate the sample to separate the fines from the rest of the sample and to bring the minus No. 200 material into suspension.
- 4.7. Repeat steps 4.5 and 4.6 until the water becomes clear. It is necessary to use the wetting agent in the repeat steps only if the sample is very dusty and/or the fines are adhering to coarse particles.
- 4.8. After the wash water becomes clear, use a syringe to wash any material retained on the No. 16 and No. 200 sieves back into the pycnometer. Take care not to lose any of this material. Fill the pycnometer to 80 to 90 percent of capacity with plain water. No wetting agent is added during this step. Replace the pycnometer top, roll to eliminate air bubbles, then completely fill the pycnometer with water, wipe off all excess water from the outside of the pycnometer, place on a balance, top off the pycnometer to a bead, and weigh to the nearest gram. Record this mass as W_2 .
- 4.9. Empty the sample from the pycnometer and completely fill it with plain water. Wipe off all excess water; place on a balance, top off the pycnometer to a bead, and weigh to the nearest gram. Record this mass as W_{bw} .

NOTE: The temperature of the water and aggregate in the pycnometer at the time W_1 and W_2 are determined shall be essentially the same as the temperature of the water at the time W_{bw} is determined. Therefore, it will become necessary to redetermine values for W_{bw} when appreciable temperature difference is noted or suspected.

5. CALCULATIONS:

- 5.1. The percentage of minus No. 200 material is calculated using the following formula:

$$\text{Percent Minus No. 200} = \frac{W_1 - W_2}{W_1 - W_{bw}} \times 100$$

Where:

- W_1 = Mass of pycnometer, water and the test portion before washing.
 W_2 = Mass of pycnometer, water and the test portion after washing.
 W_{bw} = Mass of pycnometer and water.

5.2. Determine the percent of minus No. 200 material to the nearest 0.1 %. If more than one portion is tested, combine the masses from the separate tests and calculate as one test.

6. PRECAUTIONS: The temperature of the water must remain essentially constant throughout the test.

7. REPORT:

7.1. Report the percentage of minus No. 200 material (by wash) to the nearest 0.1 percent.

7.2. When test results are obtained that do not fall within specification limits, the failure must be verified. The unused field sample is to be tested in the same manner as the original test sample. When the original and the verification test results are reasonably close they are to be averaged to obtain a single reportable test result. When the two test results vary considerably further investigation will be necessary. Investigation may include checking test equipment, reducing field sample to test sample practices, methods of calculations and/or obtaining an additional field sample to test.

APPROVED

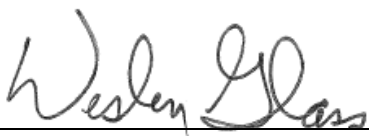

DIRECTOR
DIVISION OF MATERIALS

DATE

02/21/08

Kentucky Method 64-606-08

Revised 02/21/08

Supersedes KM 64-606-03

Dated 02/18/03

SPECIFIC GRAVITY AND ABSORPTION OF COARSE AGGREGATES

1. SCOPE:

- 1.1 This method covers the determination of bulk specific gravity (saturated surface-dry basis), bulk specific gravity (oven dry basis), apparent specific gravity, and absorption of coarse aggregate.

2. APPARATUS:

- 2.1 Sieves – Sieves shall conform to AASHTO M 92.
- 2.2 Scale/Balance – Scale or Balance accurate and readable to within 0.1 % of the test sample mass at any point within the range of use.
- 2.3 Sample Splitter
- 2.4 Test Portion Container – A wire basket with no openings larger than a (No. 6) sieve and a capacity of 4 to 7 L.
- 2.5 The container for water shall be of such height as to hold sufficient water to completely immerse the wire basket and test portion during all weightings and maintain adequate clearance between the bottom of the wire basket and bottom of the container. The inside of the container shall be at least 4 inches larger than the outside diameter of the wire basket. A large trash can is suitable.
- 2.6 Towel
- 2.7 Oven – An oven capable of maintaining $230 \pm 9^\circ \text{F}$ ($110 \pm 5^\circ \text{C}$).
- 2.8 Buckets – Buckets suitable for soaking test portion in water.
- 2.9 Drying pans

3. SAMPLING:

- 3.1 Sample the aggregate by KM 64-601 SAMPLING OF AGGREGATES FOR USE AS HIGHWAY MATERIALS. The minimum field sample size is listed in KM64-601.
- 3.2 Thoroughly mix and reduce the sample by KM 64-632. The minimum test portion mass shall be 2500-5000 grams and is obtained by shaking and washing the reduced sample over a #4 sieve and retaining the plus #4 portion for testing. Dry the test portion to constant mass at $230 \pm 9^\circ \text{F}$ ($110 \pm 5^\circ \text{C}$) and let cool before covering with water.

4. PROCEDURE:

- 4.1 Place the test portion in a container (bucket), cover with water and allow to soak for 15-24 hours.
- 4.2 Dump the sample onto a #4 sieve and then spread the sample out on a clean towel. Roll the material back and forth in the towel until all visible moisture is removed from the outside surface. This is a saturated surface-dry condition. Take care to avoid evaporation of water from aggregate pores during the operation of surface drying.
- 4.3 Weigh the test portion while it is in the saturated surface dry condition. Record this mass to the nearest gram. Record as mass "B".
- 4.4 After determining the mass, immediately place the saturated surface dry test sample in the wire basket and determine its mass under water at $73.4 \pm 3^\circ\text{F}$. Take care to remove all entrapped air before determining the mass by shaking the container while immersed. After the scale reading becomes stabilized, read and record this mass to the nearest gram. Subtract the empty basket weight under water from this value to determine the sample weight under water. Record this mass as "C".

NOTE: The wire suspending the container should be of the smallest practical size to minimize any possible effects of a variable immersed length.

- 4.5 Remove the entire test portion from the basket, dry to a constant mass at $230 \pm 9^\circ\text{F}$ ($110 \pm 5^\circ\text{C}$), and allow the sample to cool in air. Determine the dry mass of the test portion to the nearest gram. Record as mass "A".

5. CALCULATIONS:

- 5.1 Calculate specific gravity and absorption using the following equations:

$$5.1.1 \text{ Bulk (BOD) Oven Dry Specific Gravity} = \frac{A}{B-C}$$

$$5.1.2 \text{ Bulk (SSD) Specific Gravity} = \frac{B}{B-C}$$

$$5.1.3 \text{ Apparent (APP) Specific Gravity} = \frac{A}{A-C}$$

$$5.1.4 \text{ Absorption, percent (ABS)} = \left(\frac{B-A}{A} \right) \times 100$$

Where:

A = mass of oven dry test portion in air.

B = mass of saturated surface-dry test portion in air.

C = mass of saturated test portion in water.

6. REPORT:

- 6.1 Report specific gravity to the nearest hundredth.
- 6.2 Report percent absorption of the nearest tenth of a percent.
- 6.3 When test results are obtained that fail to meet specification limits, a retest will be performed. The unused field sample is to be tested in the same manner as the original test sample. When the two test results vary considerably, further investigation will be necessary. Investigation may include checking test equipment, reducing field sample to test sample practices, methods of calculations and/or obtaining an additional field sample to test.
- 6.4 The Central Office, Division of Materials shall be the final authority in all disputes involving Specific Gravity and Absorption of Coarse Aggregates.

APPROVED

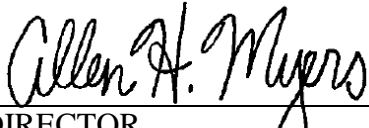

DIRECTOR
DIVISION OF MATERIALS

DATE

04/07/17

Kentucky Method 64-607-17
Dated 04/07/17

AGGREGATE PRODUCER QUALITY CONTROL

1. SCOPE: The Standard Specifications require that aggregate producers requesting to be included on the Aggregate Source List found in the Department's List of Approved Materials, establish and maintain a quality control program. This method details the procedures necessary for inclusion and maintaining status on the [Aggregate Source List](#).
2. PROCEDURES FOR INCLUSION ON THE AGGREGATE SOURCE LIST:
 - 2.1. Submit a quality control plan that defines the quality control program to be utilized to the Division of Materials for review.
 - 2.2. Employ an individual whose responsibility is quality control. The individual shall be a Qualified Aggregate Technician or be granted interim status until an individual can be qualified by the [Kentucky Aggregate Training Program](#). Also, this individual shall be knowledgeable of the source deposit and operations, finished product specifications, test methods, and any restrictions that apply to the specific aggregate source.
 - 2.3. Provide an adequate lab with all necessary equipment and supplies to obtain samples and perform tests.
3. MAINTAINING AGGREGATE SOURCE LIST STATUS:
 - 3.1. Maintain employment of a Qualified Aggregate Technician.
 - 3.2. Maintain lab and equipment in proper working condition.
 - 3.3. All testing is to be performed in accordance with the current applicable sampling and test methods. Frequency is to be determined by the producer with emphasis on areas of greatest need and as indicated on the source's approved quality control plan. Testing to be performed (where applicable) includes but is not limited to:

Dry Sieve Analysis	AASHTO T 27
Wet Sieve Analysis	AASHTO T 27 or KM 64-620
Finer than No. 200	AASHTO T 11 PROCEDURE B or KM 64-606
Shale	KM 64-604
Percent Crushed	ASTM D 5821
 - 3.4. Keep all aggregate test reports on file at source for a minimum of one year and furnish copies of all test reports upon request by Transportation Cabinet employees.
 - 3.5. Maintain a daily log of source operations (sizes produced and how deposit mined).

- 3.6. Submit to spot inspections and a yearly in-depth inspection by a Transportation Cabinet representative(s).
- 3.7. Allow Transportation Cabinet personnel access to all areas of the aggregate source in accordance with the conditions set forth in Section 106.03 of the [Standard Specifications](#).

4. REMOVAL FROM AGGREGATE SOURCE LIST:

- 4.1. Any aggregate source not complying with all the provisions of Section 3 may be placed on probation for a period of three months beginning on the date the violation is detected. If a producer, at anytime during the three month probation period, is found not performing the requirements of Section 3 then that producer may be removed from the Aggregate Source List for a period of one month.
- 4.2. In order to be reinstated on the Aggregate Source List the producer shall send an appeal to the Director of the Division of Materials. If the aggregate source demonstrates compliance with all the provisions of Section 3 after requesting reinstatement, that source will be included on the Aggregate Source List with an additional three month probation period.

5. TRANSPORTATION CABINET RESPONSIBILITY:

- 5.1. Maintain an accurate and current [List of Approved Materials](#).
- 5.2. Keep aggregate sources listed on the [Aggregate Source List](#) aware of any Transportation Cabinet sampling and test method changes.
- 5.3. Distribute copies of spot inspections and the yearly in-depth inspection to the Qualified Aggregate Technician and Aggregate Producer.

APPROVED



DIRECTOR
DIVISION OF MATERIALS

DATE

02/21/08

Kentucky Method 64-608-08
Revised 02/21/08
Supersedes KM 64-608-05
Dated 01/04/05

SOUNDNESS OF AGGREGATE BY USE OF SODIUM SULFATE

1. SCOPE -

- 1.1. This method covers the procedure to be followed in testing aggregates to determine their resistance to disintegration by a saturated solution of sodium sulfate.
- 1.2. Follows AASHTO T 104 with minor modifications.

2. APPARATUS & MATERIALS -

- 2.1. Sieves used shall conform to AASHTO M 92.
- 2.2. Containers
 - 2.2.1. Containers suitable for holding sodium sulfate solution.
 - 2.2.2. Containers for samples - 8 in. diameter sieves for each separate size fraction of aggregate. Coarse Aggregate Container – No. 8 sieve, Fine Aggregate Container – No. 60 sieve. Used out-of-tolerance sieves according to AASHTO M 92, in acceptable condition, may be used as containers.
- 2.3. Balance - A balance or scale having a capacity of not less than 5000 grams and sensitive to 0.1 gram.
- 2.4. Oven - An oven capable of maintaining a uniform temperature of 230 ± 9 °F.
- 2.5. Mechanical Shaker.
- 2.6. Hydrometer - A hydrometer with a range of at least 1.154 to 1.171 ± 0.001 .
- 2.7. Thermometer - A thermometer having a range of at least 60.0 - 90.0 °F.
- 2.8. Sodium Sulfate - Anhydrous, reagent grade (meets or exceeds reagent grade).
- 2.9. Temperature Regulation - Suitable means for regulating the temperature of the sodium sulfate solution shall be provided.
 - 2.9.1. Continuous Temperature Recorder - A device to continuously record solution temperature to ± 0.5 °F

3. SAMPLE PREPARATION -

- 3.1. Samples shall be obtained in accordance with AASHTO T 2.

- 3.2. In crushing ledge rock samples, adjust the crusher so that there will be a small amount of 1 ½ inch size material available to waste. This will ensure the sample is uniformly graded.
- 3.3. Wash fine aggregate, size 10, or size 11 samples over a No. 50 sieve and dry to a constant mass. Separate the test sample into different size fractions, as indicated in Table 1, by sieving to refusal. Any of the sizes specified in Table 1 which are present in amounts of less than 5% by mass of the sample gradation shall not be tested. Do not use aggregate sticking in the meshes of the sieves.
- 3.4. Coarse aggregate - The size designation will determine the size fractions to be tested as indicated in Table 4. Separate the test sample into the different size fractions as indicated in Table 4, by sieving to refusal. Any of the sizes specified in Table 4 which are present in amounts of less than the test fraction masses listed in Table 1 shall not be tested. Substitution of another size fraction will not be permitted. Do not use aggregate sticking in the meshes of the sieves. Wash each coarse fraction over a No. 4 sieve and then dry to a constant mass.
- 3.5. Split, weigh, and record the specified amount for each size fraction to ±1% of the mass indicated in Table 1 and place the aggregate in separate containers for the test.
- 3.6. Record masses of different size fractions to the nearest 0.1 gram.

Note: When an aggregate contains appreciable amounts of both fine and coarse aggregate, the sample may be separated on the No. 4 and tested in accordance with procedures for fine and coarse aggregate. Report the results separately for each fraction.

TABLE 1			
<u>COARSE AGGREGATE</u>		<u>FINE AGGREGATE, #10, or #11</u>	
<u>Sieve Size</u>	<u>Test Fraction Mass, g</u>	<u>Sieve Size</u>	<u>Test Fraction Mass, g</u>
-2 ½ in. + 2 in.	2000	-3/8 in. + No. 4	100
-2 in. + 1 ½ in.	2000	-No. 4 + No. 8	100
-1 ½ in. + 1 in.	1500	-No. 8 + No. 16	100
-1 in.+ ¾ in.	1000	-No. 16 + No. 30	100
-¾ in. + ½ in.	750	-No. 30 + No. 50	100
-½ in. + 3/8 in.	500		
-3/8 in. + No. 4	500		

4. PROCEDURE –

- 4.1. The saturated solution of sodium sulfate shall be prepared by dissolving the salt in water at a temperature of 77°F minimum. Sufficient salt shall be added to insure not only

saturation but also the presence of excess crystals when the solution is ready to use in the test. The mixture shall be thoroughly stirred during the addition of the salt and the solution shall be stirred at frequent intervals until used. Prior to use, bring the solution to a temperature of 68.5 to 71.5°F, stir the solution to break up salt cake, and check the specific gravity. When used, the solution shall have a specific gravity of not less than 1.154 nor more than 1.171.

- 4.2. Immerse the samples in the prepared solution for at least 16 hours and not more than 18 hours at a depth of at least ½ in. below the surface of the solution. The temperature of the solution shall be maintained at 68.5 to 71.5°F, during the entire immersion period.
- 4.3. After the immersion period, remove the containers from the solution and let drain for approximately 15 minutes. Then place the containers in the oven for at least 5 hours at a temperature of $230^{\circ} \pm 9^{\circ}\text{F}$ or for such additional time as required to ensure thorough drying.
- 4.4. After drying, cool the sample to 68 to 77°F, then re-immense into the solution as described in 4.2.
- 4.5. Repeat the process of alternate immersion and drying for 5 cycles. The test shall be performed continuously without interruption for the 5 complete cycles. However, if the test must be interrupted, leave the samples in the oven at $230^{\circ} \pm 9^{\circ}\text{F}$ until test can be resumed.
- 4.6. After completion of the fifth cycle and after the sample has cooled, rinse the sample in hot running tap water to remove any traces of salt. Rinse by circulating hot water, through the samples in their containers, by introducing hot water near the bottom and allowing the water to pass through the samples and overflow. Rinsing shall be complete when a sample of the rinse water remains clear when checked with a 5 percent barium chloride solution (5g BaCl₂ to 100 ml H₂O) Further rinsing is required if the rinse water sample becomes cloudy upon addition of the barium chloride solution. Dry each size fraction to a constant mass at a temperature of $230^{\circ} \pm 9^{\circ}\text{F}$.

Note: Some sources of water may naturally display cloudiness upon addition of the barium chloride solution. In these instances, the wash water shall be judged free of sodium sulfate when the degree of cloudiness is no greater than when testing the source water alone.

- 4.7. After drying, sieve over the size sieve specified in Table 2 by hand sieving with agitation sufficient only to assure all undersize material passes the designated sieve. No extra manipulation shall be employed to break up particles or cause them to pass the sieves. Weigh the particles retained on each sieve to the nearest 0.1 gram and record the mass.

TABLE 2	
<u>Size Fraction</u>	<u>Sieve Used to Determine Loss</u>
-2 ½ in. + 1 ½ in.	1 ¼ in.
-1 ½ in. + ¾ in.	5/8 in.
-¾ in. + ⅜ in.	5/16 in.
-⅜ in. + No. 4	No. 5
Fine Aggregates	Same sieves used in set up

5. CALCULATIONS -

5.1. Coarse Aggregate (Original Sample)

- 5.1.1. Add the initial masses of the different size fractions as recorded in 3.6.
- 5.1.2. Add the masses of the different size fractions after testing as determined in 4.7.
- 5.1.3. Subtract the sum obtained in 5.1.2 from the sum obtained in 5.1.1. To obtain the percent loss, divide this difference by the sum in 5.1.1 and multiply by 100.

5.2. Coarse Aggregate Verification Samples when required, (see 6.2.2) and Fine Aggregate Samples are to be calculated by weighted average based on the grading of the sample as received (see Table 3 for example).

- 5.2.1. For fine aggregates (with less than 10 % coarser than the 3/8 in. sieve), assume sizes finer than the No. 50 sieve to have 0 % loss and sizes coarser than the 3/8 in. sieve to have the same loss as the next smaller size for which test data are available.
- 5.2.2. For coarse aggregate, assume sizes finer than No. 4 sieve to have the same loss as the next larger tested size and sizes coarser than those required in Table 4 for the size designation to have the same loss as the next smaller tested size.
- 5.2.3. For an aggregate containing appreciable amounts of both fine and coarse material (base aggregates, etc.) the verification shall be tested as two separate samples, fine and coarse. Compute the weighted average separately for the minus No. 4 and plus No. 4 fractions. Report the results separately with the plus No. 4 compared to the original failure.
- 5.2.4. For the purpose of calculating the weighted average, consider any size in table 4 that contains less than five percent of the sample to have the same loss as the average of the next smaller and the next larger size, or if one of these sizes is absent, to have the same loss as the next larger or next smaller size, whichever is present.

5.2.5. For large rock or ledge rock which requires crushing the weighted average shall be the arithmetic mean of the loss on the fractions tested.

5.3. In addition a qualitative examination may be performed, in which individual particles are examined for splitting, crumbling, cracking, flaking, etc. This information, in conjunction with the quantitative analysis, will be used to determine aggregate soundness.

6. REPORT:

6.1. Report the percent loss determined in Section 5 to the nearest whole percent.

6.2. Reporting of results when failures are encountered –

6.2.1. Fine Aggregate: When test results are obtained that do not fall within specification limits, the failure must be verified. Additional soundness testing shall be performed on the unused field sample. The verification soundness shall be tested in the same manner as the original test sample. The original failure and the verification will be calculated by weighted average based on the grading of the field sample. When the original and the verification test are reasonably close, they are to be averaged to obtain a single reportable test result. When the two tests vary considerably, further investigation will be necessary. Investigation may include checking test equipment, reviewing practices of reducing field sample to test sample, checking calculations and/or obtaining an additional field sample for testing.

6.2.2. Coarse Aggregate: When test results are obtained that do not fall within specification limits, the failure must be verified. A gradation and verification soundness shall be performed on the unused field sample. The verification soundness shall be tested in the same manner as the original test sample, except the verification will be set up based on the grading of the field sample (all screens with 5% or more retained will be used for soundness) and calculated by weighted average. The verification soundness will also be re-calculated as outlined in 5.1 for the same screen(s) as used in the original sample setup. If this re-calculated result varies considerably from the original test sample result, further investigation will be necessary. Investigation may include checking test equipment, reviewing practices of reducing field sample to test sample, checking calculations and/or obtaining an additional field sample to test. If the aforementioned comparison is satisfactory, the weighted average result will be the reported test result.

APPROVED

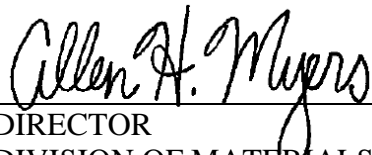

DIRECTOR
DIVISION OF MATERIALS

DATE

08/04/14

Kentucky Method 64-610-14
Revised 08/04/14
Supersedes KM 64-610-14
Dated 12/13/01

Attachments

KM 64-610-14

TABLE 3				
<u>SIEVE SIZE</u>	<u>SAMPLE GRADATION PERCENT RETAINED</u>	<u>MASS OF TEST FRACTIONS BEFORE TEST</u>	<u>PERCENT WT. LOSS AFTER TEST</u>	<u>WEIGHTED PERCENTAGE LOSS</u>
1 1/2"	0			
1"	3			
3/4"	22	1000	3.2	0.8*
1/2"	45	750	2.7	1.2
3/8"	20	500	5.8	1.2
No. 4	7	500	6.4	0.6**
No. 8	2			
PAN	1			
TOTAL				3.8 = 4 % loss

Weighted percentage loss is calculated by multiplying the percent retained from the sample gradation by the corresponding screen's percent of weight loss after test. The individual screen's percentage losses are then combined to report total soundness loss.

*Since the 1" sieve had less than 5 % retained from the sample gradation, it is accounted for by adding its retained percentage (3 %) to the retained percentage of the 3/4" (22 %). The combined percentages (25 %) are then multiplied by the percentage of weight loss after test for the 3/4" sieve (.032). This will derive the weighted percentage loss of 0.8 for the 3/4" sieve.

**Both the No. 8 sieve and the pan have less than 5 % retained and are accounted for by adding their retained percentages to the retained percentage of the No. 4 sieve and multiplying this total (10 %) by the percentage of weight loss after test for the No. 4 sieve (.064).

TABLE 4 SIEVE FRACTIONS TO BE TESTED BY COARSE AGGREGATE SIZE DESIGNATION										
Size Designation	-2 1/2 in. + 2 in.	-2 in. + 1 1/2 in.	-1 1/2 in. + 1 in.	-1 in. + 3/4 in.	-3/4 in. + 1/2 in.	-1/2 in. + 3/8 in.	-3/8 in. + No. 4			
1	X	X								
2	X	X								
23	X	X	X							
3		X	X							
357		X	X	X	X					
4			X	X						
467			X	X	X	X				
5				X	X					
57				X	X	X	X			X
610				X	X	X	X			X
67					X	X	X			X
68					X	X	X			X
710					X	X	X			X
78						X	X			X
8							X			X
9-M										X
DGA					X		X			X
Gravel Base				X	X	X	X			X
CSB				X	X	X	X			X
Ledge Rock			X	X	X	X	X			X
10	Tested as fine aggregate									
11	Tested as fine aggregate									

DETERMINATION OF COAL AND LIGNITE IN AGGREGATES

1. SCOPE:

- 1.1. This method covers the determination of the percentage of coal and lignite in both fine and coarse aggregates. The determination in fine aggregate is made by means of sink-float separation in a heavy liquid of suitable specific gravity; the determination in coarse aggregate is made by visual classification.
- 1.2. The fine aggregate procedure generally follows AASHTO T 113 with slight modifications.

2. APPARATUS and MATERIALS:

- 2.1. Balance - Fine Aggregates: A balance having a capacity of not less than 500 grams, sensitive to 0.1 gram. Coarse Aggregates: A balance having a capacity of not less than 5000 grams, sensitive to 1 gram.
- 2.2. Containers: Suitable for drying the aggregate sample, holding aggregate during immersion and suitable for holding the heavy liquid during the sink-float separation.
- 2.3. Skimmer: A piece of No. 50 sieve cloth of suitable size and shape for separating the floating pieces from the heavy liquid.
- 2.4. Oven: An oven capable of maintaining a uniform temperature of $230 \pm 9^\circ \text{F}$
- 2.5. Sieves: No. 50 and No. 4 conforming to AASHTO M 92.
- 2.6. Hydrometer: A hydrometer conforming to the requirements of Section 5 through 11 of ASTM E 100.
- 2.7. The heavy liquid shall consist of a mixture of zinc bromide and water. The proportioning shall be such that the specific gravity of the mixture shall be maintained at 2.00 ± 0.01 at all times during testing. (Percentages by mass to produce the required specific gravity of 2.00 using zinc bromide and water are 66% zinc bromide and 34% water. (See Note 2) However, the specific gravity of the heavy liquid must be periodically verified by use of the hydrometer and adjustments made as necessary to maintain the required specific gravity.)

NOTE 1: CAUTION. Read warning statements in MSDS (Material/Safety Data Sheets) before initiating testing with zinc bromide.

NOTE 2: Heat is generated upon mixing zinc bromide and water. Zinc bromide should be added to water NOT the reverse.

3. SAMPLE:

3.1. Field samples shall be obtained in accordance with AASHTO T 2.

3.2. Test Portion: The test portion shall be prepared from the minimum field sample from AASHTO T 2 or below by: (1) reducing the sample in accordance with AASHTO T 248*, (2) oven-drying the reduced sample to constant mass and (3) after allowing the reduced sample to cool to room temperature, separating over a No. 4 sieve if coarse aggregate or over a No. 50 sieve if fine aggregate.

*The sample shall be reduced to a size such that the minimum mass of test portion (consisting of material retained on the No. 4 and No. 50 sieve, as applicable) shall not be less than that indicated in the following table:

NOMINAL MAXIMUM SIZE OF AGGREGATE	MINIMUM MASS OF FIELD SAMPLE	MINIMUM MASS OF TEST PORTION
No. 4 or smaller	10 lbs.	200 grams
3/8"	30 lbs.	3000 grams
1"	50 lbs.	5000 grams
2"	90 lbs.	10000 grams

4. PROCEDURE:

4.1. Fine Aggregate: Weigh the material coarser than the No. 50 sieve to the nearest 0.1 gram, record as W_2 and bring to a saturated surface dry condition by means of the procedure specified in KM 64-605. Introduce the test portion into the heavy liquid in a suitable container, the volume of the liquid being at least three times the absolute volume of the aggregate (Note 4). Using the skimmer, remove the pieces that rise to the surface, and save them. Repeatedly agitate the remaining pieces, and remove the floating pieces until no additional pieces rise to the surface. Wash the skimmed pieces in water. After drying, separate the coal and lignite from the skimmed pieces by visual inspection. Weigh and record the mass of the coal and lignite as W_1 .

NOTE 3: If the absorption as determined in accordance with KM 64-605 is known, the fine aggregate may be prepared for test by adding to a known mass of dry sand the amount of water it will absorb, mixing thoroughly, and permitting the sand to stand in a covered pan for 30 minutes before use.

NOTE 4: Test portion may be introduced into the heavy liquid by slowly pouring the aggregate into the container that has already been placed in the heavy liquid. Partial separation of the lightweight particles will be achieved and will reduce the chance of lightweight particles being unable to float to the surface by becoming entrapped by other aggregate. Proceed with agitation.

NOTE 5: Normally the discrepancy between oven-dry mass and saturated-surface-dry mass of the skimmed particles will not significantly affect the calculated percentage of coal and lignite. If a more precise determination is required, the skimmed particles shall be dried to a constant mass to determine the value of W_1 used for the calculation in Section 5.

- 4.2. Coarse Aggregate: Obtain the appropriate size test portion by wet sieving the sample over a No. 4 sieve and retaining the plus No. 4 material for testing. Spread the wet portion on a sufficient work area so that individual particles may be carefully inspected. Separate the coal and lignite from the test portion by visual classification. When separation has been completed, surface dry the coal and lignite, as well as the remaining portion of the original sample, and weigh each pile separately. Record the mass of the coal and lignite as W_1 , and the remaining material as W_3 .

5. CALCULATIONS:

Calculate the percentage of coal and lignite as follows:

$$\text{Fine Aggregate : \% Coal and Lignite} = \frac{W_1}{W_2} \times 100$$

$$\text{Coarse Aggregate : \% Coal and Lignite} = \frac{W_1}{W_1 + W_3} \times 100$$

Where:

W_1 = Dry mass of Coal and Lignite in sample.

W_2 = Dry mass of Plus No. 50 Materials (Fine Agg. Sample)

W_3 = Dry mass of remaining portion of plus No. 4 material after coal and lignite have been removed (Coarse Agg. Sample).

6. REPORT:

- 6.1. Report results to the nearest 0.1 of a percent.
- 6.2. When test results are obtained that do not fall within specification limits, the failure must be verified. The unused field sample is to be tested in the same manner as the original test sample. When the original and the verification test results are reasonably close, they are to be averaged to obtain a single reportable test result. When the two test results vary considerably, further investigation will be necessary. Investigation may include checking test equipment, reducing field sample to test sample practices, methods of calculations and/or obtaining an additional field sample to test.

APPROVED

Allen H. Myers

DIRECTOR
DIVISION OF MATERIALS

DATE

08/04/14

Kentucky Method 64-615-14

Revised 08/04/14

Supersedes KM 64-615-08

Dated 02/06/03

METALLIC IRON CONTENT IN SLAG

1. SCOPE: This method covers the determination of particles (by mass) containing iron in blast furnace slag or similar products.
2. APPARATUS:
 - 2.1. Magnet: A magnet with a manufacturer's rating of approximately 50 lbs.
 - 2.2. Sample Splitter
 - 2.3. Balance: A balance having a capacity of at least 5000 grams, sensitive to one gram.
 - 2.4. Oven: An oven capable of maintaining a uniform temperature of approximately 230±9°F.
 - 2.5. Drying pans
3. SAMPLE:
 - 3.1. Field samples shall be obtained in accordance with AASHTO T 2.
 - 3.2. Obtain the test portion in accordance with AASHTO T 248. A representative quantity of sample to be tested shall be in accordance with the following table:

<u>Nominal Maximum Sieve Size</u>	<u>Approx. Weight of Test Portion</u>
3/8 inch or Less	1500 - 2000 grams
1/2 inch to 1 inch	2500 - 3500 grams
Greater than 1 inch	5000 - 7000 grams
 - 3.3. Dry the test portion to constant mass in the oven at 230±9°F.
 - 3.4. Cool the test portion to room temperature.
 - 3.5. Weigh the test portion and record the mass to the nearest gram as W_1 .
4. PROCEDURE:
 - 4.1. Spread the test portion out on a table or other work area so that all aggregate particles are touching the table surface and are exposed to the magnet when passed over the surface of the layer of aggregate.
 - 4.2. Pass the magnet over the aggregate layer touching as many particles as possible. Remove all particles collected by the magnet and place them in a separate pile.
 - 4.3. Remix the remaining test portion and repeat steps 4.1 and 4.2. Repeat this procedure until the mass of the particles collected on a given pass of the magnet is less than 0.1 percent of the original mass of the test portion.
 - 4.4. Weigh all the particles collected by the magnet and record this mass as W_2 .

5. CALCULATIONS:

$$\text{Percent Metallic Iron Materials} = \frac{W_2}{W_1} \times 100$$

Where: W_1 = Mass of total test portion

W_2 = Mass of material removed by magnet

6. REPORT:

6.1. Report the percent metallic iron particles to the nearest whole percent.

APPROVED

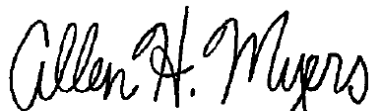

DIRECTOR
DIVISION OF MATERIALS

DATE

08/04/14

Kentucky Method 64-618-14
Revised 08/04/14
Supersedes KM 64-618-08
Dated 12/16/02

WET SIEVE ANALYSIS OF FINE AND COARSE AGGREGATE

1. SCOPE:

- 1.1. This method covers a procedure for the determination of the particle size distribution of certain fine and coarse aggregates by combining Percentage of Material Finer than a No. 200 Sieve By Use of A Pycnometer (Wash Test) ([Ky Method 64-606](#)) and Sieve Analysis of Fine and Coarse Aggregate (AASHTO T 27).
- 1.2. Application - This method shall be used for the following sizes and/or uses of aggregates: Dense Graded Aggregate Base (DGA), Crushed Stone Base (CSB), or when otherwise specified. This method does not apply to the sieve analysis of Mineral Filler. AASHTO T 37 should be used for the sieve analysis of Mineral Filler.

2. APPARATUS:

- 2.1. Sieves - Sieves which are necessary to furnish the information as required by the applicable specification. Sieves shall conform to AASHTO M 92.
- 2.2. Balance - A balance capable of weighing at least 7000 grams, sensitive and accurate to one gram.
- 2.3. Pycnometer - A plastic or glass jug with a capacity of approximately 1 gallon fitted with a pycnometer top. The jug must maintain a constant volume during test.
- 2.4. Wetting Agent - Calgon powder is preferred.
- 2.5. Funnel
- 2.6. Towels
- 2.7. Syringe
- 2.8. Sample Splitter
- 2.9. Container suitable for soaking aggregates.
- 2.10. Drying Oven - An oven capable of maintaining a constant temperature of $230 \pm 9^{\circ}\text{F}$.
- 2.11. Drying Pans
- 2.12. Mechanical Shaker (Optional)

3. SAMPLE:

3.1. Field samples shall be obtained in accordance with AASHTO T 2.

3.2. The minimum field sample mass and the mass of the test portion are listed in the following table. The sample shall be reduced in size in accordance with AASHTO T 248.

NOMINAL MAXIMUM SIZE	MINIMUM MASS OF FIELD SAMPLE	MINIMUM MASS OF TEST PORTION
No. 4 or less	10 lbs.	1000 grams
3/8"	10 lbs.	1500 grams
1/2"	20 lbs.	2500 grams
3/4"	30 lbs.	3000 grams
1"	50 lbs.	5000 grams
1 1/2"	70 lbs.	7000 grams
2"	90 lbs.	15000 grams
2 1/2"	125 lbs.	20000 grams

3.3. When the size of the test portion exceeds the capacity of the pycnometer (greater than approximately 3500 grams for most aggregates) the test portion shall be divided into as many approximately equal parts by mass as necessary to insure against overfilling of the pycnometer. All divided parts shall be tested.

3.4. Retain unused field sample until all testing is completed.

4. PROCEDURE:

4.1. The test procedure will consist of two distinct parts; the minus No. 200 wash test and the dry sieve analysis, in that order.

4.2. Perform current [KM 64-606](#) Percentage of Material Finer than a No. 200 Sieve by Use of a Pycnometer (Wash Test).

4.3. Retain and combine all material from all portions tested. Dry to a constant mass.

4.4. Perform AASHTO T-27 Sieve Analysis of Fine and Coarse Aggregates on material retained from section 4.3

5. CALCULATIONS:

5.1. The percent passing each sieve on the wet sieve analysis is calculated as follows:

$$P1 = (((100-P2)/100) \times P3) + P2$$

Where

P1 = Percent passing each sieve on the wet sieve analysis

P2 = Percent minus 200 sieve as determined by [KM 64-606](#)

P3 = Percent passing each sieve as determined in the dry sieve analysis

6. REPORT:

6.1. The results of the wet sieve analysis shall be reported as the total percentages passing each sieve. Percentages shall be reported to the nearest whole number.

6.2. When test results are obtained that do not fall within specification limits, the failure must be verified. The unused field sample is to be tested in the same manner as the original test sample. When the original and the verification test results are reasonably close, they are to be averaged to obtain a single reportable test result. When the two test results vary considerably further investigation will be necessary. Investigation may include checking test equipment, reviewing sampling and splitting practices, methods of calculations and/or obtaining an additional field sample to test

APPROVED

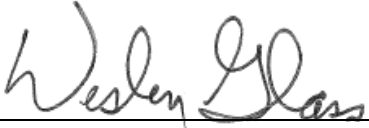

DIRECTOR
DIVISION OF MATERIALS

DATE

02/21/08

Kentucky Method 64-620-08

Revised 02/21/08

Supersedes KM 64-620-06

Dated 05/30/06

PORE INDEX VALUE OF AGGREGATE

1. SCOPE -
 - 1.1. This method covers the procedure to be followed when testing aggregates to determine their Pore Index Value.
 - 1.2. The Iowa Pore Index Test was used as a reference.
2. APPARATUS
 - 2.1. Sieves - Sieves used shall conform to AASHTO M 92.
 - 2.2. Containers - Containers suitable for holding aggregates without rusting.
 - 2.3. Balance - A balance or scale having a capacity of not less than 5,000 grams and sensitive to 1 gram.
 - 2.4. Oven - An oven capable of maintaining a uniform temperature of $230 \pm 9^{\circ}\text{F}$.
 - 2.5. Mechanical Shaker
 - 2.6. Pore Index Apparatus - Capable of measuring the amount of water (milliliters) absorbed under 35 psi air pressure. See Illustration No. 1.
3. SAMPLE PREPARATION -
 - 3.1. Field samples shall be obtained in accordance with AASHTO T2.
 - 3.2. Reduce field sample by AASHTO T 248 to obtain approximately 10000 grams of aggregate (size; passing 1 inch, retained on 1/2 inch shall be obtained by sieving over a 1 inch and 1/2 inch sieve).
 - 3.3. Wash the retained aggregate until free of dust.
 - 3.4. Dry the sample to a constant mass.
 - 3.5. After drying allow the sample to cool to room temperature.
4. PROCEDURE -
 - 4.1. Obtain 9000 grams of prepared aggregate and place into the bowl of the Pore Index apparatus. Place lid on bowl and secure carefully. Close water inlet valve and air vent valve. Check to see if container is air tight by applying 35 psi of air pressure. The container must hold 35 psi with no noticeable drop in pressure. After pressure test, close air input valve and

open air vent valve.

NOTE: A test sample mass of 4500 grams may be used for routine testing. Multiply the Pore Index results by 2 when 4500 grams is tested. A 9000 gram sample is required for referee testing such as pass/fail decisions.

- 4.2. Open water inlet valve. Fill with water to the zero mark. Be sure pressure gage does not move above normal atmospheric pressure. (0 gage reading).
- 4.3. Close water and air vent valves immediately after filling with water to zero mark.
- 4.4. Open air input valve leading to the constant 35 psi air pressure source.
- 4.5. Record water level, R_1 in ml, at precisely one (1) minute after the air pressure was introduced.
- 4.6. Retain constant 35 psi air pressure until 14 additional minutes have elapsed. Record water level, in ml R_{15} , at this precise moment.
- 4.7. Slowly open water output valve (same as input valve) and expel water into drainage system.
- 4.8. Close air input valve and remove lid. Then remove sample.

5. CALCULATIONS -

- 5.1. Subtract one (1) minute reading (R_1) from fifteen (15) minute reading (R_{15}) and record as the Pore Index PI:

$$PI = R_{15} - R_1$$

NOTE: for 4500 gm. sample, $PI = 2 (R_{15} - R_1)$

6. PRECAUTIONS -

- 6.1. A constant air pressure of 35 psi must be maintained during the entire test.
- 6.2. Eye and face protection must be worn when air pressure is applied.

7. REPORT -

- 7.1. Report results to the nearest whole number.

- 7.2. When test results are obtained that vary significantly from the source's historical data, the test result must be verified. The unused field sample is to be tested in the same manner as the original test sample. When the original and the verification test results are reasonably close (10 or less for a 9000 gram sample, 5 or less for a 4500 gram sample), they are to be averaged to obtain a single reportable test result. When the variability of the two test results is beyond these limits, further investigation will be necessary. Investigation may include checking test equipment, reducing field sample to test sample practices, methods of calculations and/or obtaining an additional field sample to test.

APPROVED

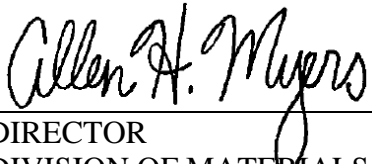

DIRECTOR
DIVISION OF MATERIALS

DATE

08/15/14

Kentucky Method 64-623-14
Revised 08/15/14
Supersedes KM 64-623-08
Dated 03/08/04

Attachment

MODIFIED CONCRETE AIR METER
WITH SE TUBE ATTACHED
(ILLUSTRATION #1)

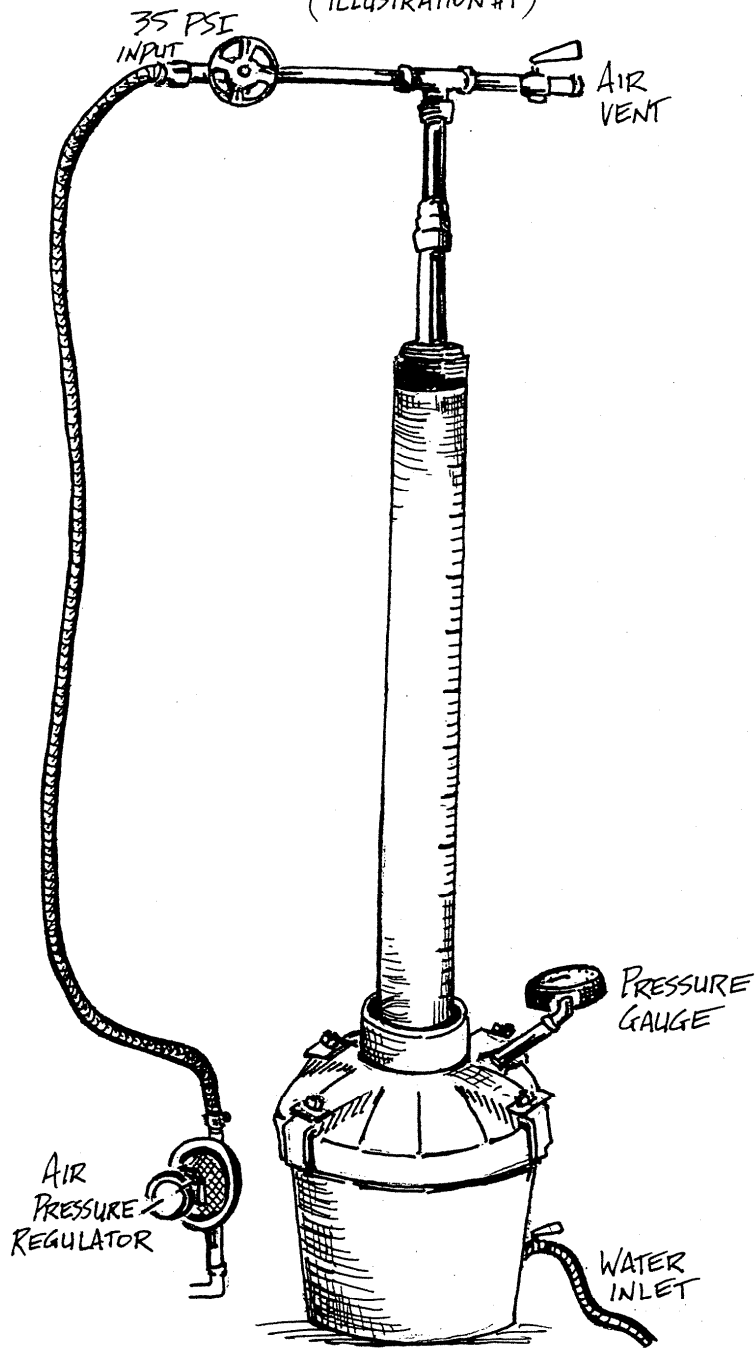

KM 623

RESISTANCE OF CONCRETE TO FREEZE-THAW TESTING

1. SCOPE:
 - 1.1. This method covers the test to determine the resistivity of concrete specimens to rapidly repeated cycles of freezing in air and thawing in water in the laboratory.
 - 1.2. Follows ASTM C 666, Procedure B with exceptions and/or modifications. These are shown with the ASTM C 666 sections and paragraphs listed for reference.
2. APPARATUS: Subsection 4.4. Length change comparator accurately reading to the 0.0001 inch is required.
3. FREEZING AND THAWING CYCLE: Subsection 5.2. Freeze thaw cycle will be 3 hours \pm 0.5 hour.
4. TEST SPECIMENS:
 - 4.1. Subsection 7.1. Prepare and cure test specimens in accordance with ASTM C 1646 with the following exceptions:
 - 4.1.1 Coarse aggregate shall be oven dried to a constant weight, then cooled to room temperature. Recombine coarse aggregate samples according to ASTM C 1646 table 1 or appendix A as appropriate.
 - 4.1.2 Fine aggregate shall be natural sand meeting requirements of 804.03 KY specs.
 - 4.1.3 Proportion concrete mixes for normal weight aggregate as indicated in [Tables 1 or 2](#) as appropriate.
 - 4.1.4 Proportion concrete mixes for lightweight aggregate as determined by the Central Materials Laboratory.
 - 4.1.5 Batch weight of oven dried coarse aggregate shall be immersed in water approximately 24 hours prior to mix. Excess water is decanted over a #200 sieve. Then all + #200 material is placed in the mixer. Remember to use a larger sieve to protect the #200.
 - 4.1.6 Master Builder's Micro Air air entraining admixture shall be used in a quantity sufficient to achieve an acceptable air content.
 - 4.1.7 Method of consolidation shall be rodding.

- 4.1.8 Two concrete beam test specimens shall be made and tested for limestone samples and three concrete beams shall be made and tested for gravel samples.
- 4.1.9 Label the concrete beam specimens by scratching the sample id into the finished surface. This should be done before the concrete is fully set and avoid disturbing the underlying aggregate.
- 4.1.10 One concrete 4x8 cylinder shall be made for each sample, cured in hydrated lime water and tested for compressive strength at 28 days.
- 4.1.11 Initial cure. Concrete beams shall be covered with a layer of wet cloth and then with a layer of plastic to prevent rapid evaporation for the first 22 ± 2 hours.
- 4.2. Subsection 7.2. Specimens shall be 3 inches in depth, 4 inches in width, and 16 inches in length where the concrete beam shall have a gauge length of 14.75 inches. The gauge length is the innermost length between the gauge studs within a concrete beam.

5. PROCEDURE:

- 5.1. Subsection 8.1. Beam specimens for lightweight aggregate concrete applications where the concrete will not be exposed to moisture sufficient to approach critical saturation, as determined by the Engineer, shall be cured as follows: Beam specimens shall be immersed in water saturated with calcium hydroxide for a period of 14 days, allowed to air-dry for 14 days, then reimmersed for 24 hours in water prior to freeze thaw testing.
- 5.2. Subsection 8.3. Introduce new specimens to the testing chamber in the thawing phase of the cycle. Allow temperature of the new specimens to reach 40 ± 3 degrees F for the zero cycle measurements by letting them sit in the circulating thaw water for approximately one hour. Continue each specimen in the test until it has been subjected to a minimum of 350 cycles or until deterioration promotes removal.

6. CALCULATION: Subsection 9.3. When the 350 cycle count is exceeded, then interpolation of the percent expansion will be necessary. The interpolation calculation will be based on the cycle count immediately before and after the 350 cycle count is reached.

7. REPORT:

- 7.1. Subsection 10.2.3. Air content of fresh concrete conforming to [Kentucky Method 64-303](#).
- 7.2. Subsection 10.2.4. Unit weight of fresh concrete is not required.
- 7.3. Subsection 10.2.5. Consistency (slump) of fresh concrete conforming to [Kentucky Method 64-302](#).
- 7.4. Subsection 10.2.6. Air content of the hardened concrete is not required.
- 7.5. Subsection 10.5.1. Dimensions of specimens at zero cycles of freezing and thawing is not required.

- 7.6. Subsection 10.6.1. The durability factor shall be reported to the nearest whole number.
- 7.7. Subsection 10.6.2. Report the percentage of expansion to the nearest 0.01 percent.
- 7.8. Reports shall contain the following information:
 - 7.8.1. Producer name
 - 7.8.2. Date beam was cast
 - 7.8.3. Ledge or Bench location
 - 7.8.4. Start and ending date of test
 - 7.8.5. Number of test cycles completed
 - 7.8.6. Bi-weekly length, weight, and fundamental transverse readings
 - 7.8.7. Durability factor
 - 7.8.8. Percent expansion
 - 7.8.9. Pass / Fail determination

APPROVED

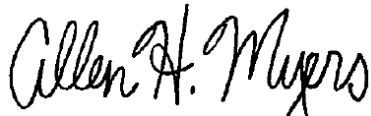

DIRECTOR
DIVISION OF MATERIALS

DATE

08/04/14

Kentucky Method 64-626-14
Revised 08/04/14
Supersedes 64-626-08
Dated 02/25/05

TABLE 1

LIMESTONE SPECIMENS (2 BEAMS)		
	Size #57's, 67's, & 68's	Size # 8's, 9m's, & 78's
TYPE 1 CEMENT (lbs)	16.6	16.6
CONCRETE SAND (lbs)	35.2 x 1.0 + % moisture of sand in decimal. (Example: 3.4 % moisture) $35.2 \times 1.034 = 36.4$ lbs.	39.2 x 1.0 + % moisture of sand in decimal. (Example: 3.4 % moisture) $39.2 \times 1.034 = 40.5$ lbs.
STONE (lbs)	54.6	50.7
AIR (%)	4 - 8 %	5 - 9 %
AIR ENTRAINMENT (ml)	5.0 ml (Adjust As Needed)	5.0 ml (Adjust As Needed)
SLUMP (in)	2 - 4 Inches	2 - 4 Inches
ESTIMATED WATER (lbs)	3.5 - 4.5 lbs. (Adjust As Needed)	3.5 - 4.5 lbs. (Adjust As Needed)

TABLE 2

GRAVEL SPECIMENS (3 BEAMS)		
	Size #57's, 67's, & 68's	Size # 8's, 9m's, & 78's
TYPE 1 CEMENT (lbs)	20.9	20.9
CONCRETE SAND (lbs)	44 x 1.0 + % moisture of sand in decimal. (Example: 3.4 % moisture) $44 \times 1.034 = 45.5$ lbs.	49 x 1.0 + % moisture of sand in decimal. (Example: 3.4 % moisture) $49 \times 1.034 = 50.7$ lbs.
STONE (lbs)	60.5	57.4
AIR (%)	4 - 8 %	5 - 9 %
AIR ENTRAINMENT (ml)	5.5 ml (Adjust As Needed)	5.5 ml (Adjust As Needed)
SLUMP (in)	2 - 4 Inches	2 - 4 Inches
ESTIMATED WATER (lbs)	3 - 4 lbs. (Adjust As Needed)	3 - 4 lbs. (Adjust As Needed)

Appendix A

Amounts Finer Than Each Laboratory Sieve, Mass Percent							
	Nominal	25.0 mm	19.0 mm	12.5 mm	9.5 mm	4.75 mm	2.36 mm
Size No.	Max. Size	[1 in.]	[3/4 in.]	[1/2 in.]	[3/8 in.]	[No. 4]	[No. 8]
57	25.0 mm [1 in.]	100	75	40		0	
67	19.0 mm [3/4 in.]		100	60	35	0	
68	19.0 mm [3/4 in.]		100	75	40	15	0
78	12.5 mm [1/2 in.]			100	55	15	0
9M	9.5 mm [3/8 in.]				100	10	0
8	9.5 mm [3/8 in.]				100	20	0

Note: Should the above required fractions not be available in the sample, the sample will not be tested for freeze-thaw resistance.

Kentucky Method 64-627-08
Dated 02/21/08
Supersedes KM 64-627-06
Dated 05/30/06

PROCEDURE FOR VERIFYING OVEN TEMPERATURE

1. PURPOSE:
 - 1.1 This method provides instructions for verifying the dial setting on aggregate drying ovens..
2. INSPECTION EQUIPMENT REQUIRED:
 - 2.1 A thermometer calibrated by an NIST traceable thermometer, graduated in at least 1-degree increments and having a range, which includes the temperature range to be verified.
 - 2.2 A brass thermometer well or similar device to retain heat while the oven door is open. This is essential for a constant temperature reading.
3. PROCEDURE:
 - 3.1 Bring oven to temperature range to be verified.
 - 3.2 Place the thermometer in the brass well and position the thermometer on the shelf where the samples are normally dried.
 - 3.3 Oven must remain undisturbed for minimum of 1 hour before first reading.
 - 3.4 Take as many readings as necessary to determine if the temperature range is within the specified tolerance (three consecutive readings taken no less than 30 minutes apart are adequate).
 - 3.5 Adjust the temperature of the oven if an observed temperature reading is outside the tolerance specified (allow at least 30 minutes for the temperature to stabilize between each adjustment). Return to step 3.4.
4. REPORT: See attached [Equipment Verification Record](#).

APPROVED

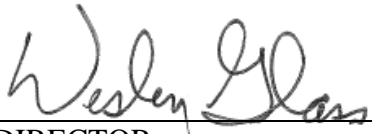

DIRECTOR
DIVISION OF MATERIALS

DATE

02/21/08

Kentucky Method 64-627-08

Dated 02/21/08

Supersedes KM 64-627-06

Dated 05/30/06

Attachments

Kentucky Transportation Cabinet, Division of Materials
Aggregate Section

EQUIPMENT VERIFICATION RECORD

Inspector: _____ Date: _____

Previous Verification Date: _____ Next Due Date: _____

Model / Serial No. _____

Equipment Name: Drying Oven Verification Frequency: 4 Months

Verification Equipment Used: Thermometer

Thermometer Serial No. _____

Verification Procedure: KM64-627

Date	Time	Set Temp (°F) or (°C)	Actual Temp
		230° (+/- 9°) F 110° (+/- 5°) C	

Comments: _____

6/1/06

Kentucky Method 64-628-08
Dated 02/21/08
Supersedes KM 64-628-06
Dated 05/30/08

PROCEDURE FOR VERIFYING MEASURED SIEVES

1. PURPOSE:
 - 1.1. This method provides instructions for checking the physical condition of laboratory test sieves ranging in size from 4-inch down through No. 4.
2. INSPECTION EQUIPMENT REQUIRED:
 - 2.1. Calipers readable to 0.01 mm.
3. TOLERANCE:
 - 3.1. Sieves shall meet the physical requirements specified in AASHTO M92.
4. PROCEDURE:
 - 4.1. Select and mark 4 individual sieve openings along a 45° line. Measure and record both dimensions of the opening to the nearest 0.01 mm. Determine the average dimension of all 8 measures.
 - 4.1.1. If the sieve is too large to have 4 holes in a 45° line, then measure at random 4 holes in the sieve.
 - 4.1.2. If the sieve does not have 4 holes, measure all the holes and average the dimensions.
 - 4.2. Verify that the average is within specification listed in AASHTO M92 Table 1 column 4.
 - 4.3. Inspect the general condition of the sieve. Check the frame and solder joints for cracks or holes.
 - 4.4. Make sure the sieve has an appropriate label.
 - 4.5. Check for tightness of the wires on each sieve.
 - 4.6. Sieves that do not comply with specifications should be clearly marked and/or discarded.

5. REPORT: See attached [Equipment Verification Record](#).

APPROVED

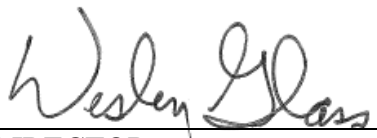

DIRECTOR
DIVISION OF MATERIALS

DATE

02/21/08

Kentucky Method 64-628-08

Dated 02/21/08

Supersedes KM 64-628-06

Dated 05/30/06

Attachment

Kentucky Transportation Cabinet, Division of Materials
Aggregate Section

EQUIPMENT VERIFICATION RECORD

Inspector: _____

Date: _____

Equipment Name: Measured Sieves

Previous Verification Date: _____

Next Due Date: _____

Verification Frequency: 6 Months

Verification Procedure Used: KM 64-628

Caliper Model No. _____

Caliber Serial No. _____

Indicate Sieve Size Being Measured: (8" - 12" - 15" x 24")

Sieve Size	1-H	1-V	2-H	2-V	3-H	3-V	4-H	4-V	TOTAL	AVG	RESULT	SIEVE CONDITION
100mm												
90mm												
75mm												
63mm												
50mm												
37.5mm												
25mm												
19mm												
12.5mm												
9.5mm												
6.3mm												
4.75mm												

100mm	=	4 in.	25mm	=	1 in.
90mm	=	3.5 in.	19mm	=	3/4 in.
75mm	=	3 in.	12.5mm	=	1/2 in.
63mm	=	2.5 in.	9.5mm	=	3/8 in.
50mm	=	2 in.	6.3mm	=	1/4 in.
37.5mm	=	1.5 in.	4.75mm	=	#4

Note: For larger size sieve tolerances, see table 1 of AASHTO M 92.

Compare average to these tolerances

Sieve Size	Tolerance	Sieve Size	Tolerance
2" 50mm	+/- 1.5mm	1/2" 12.5mm	+/- 0.39mm
1.5" 37.5mm	+/- 1.1mm	3/8" 9.5mm	+/- 0.3mm
3/4" 19mm	+/- 0.6mm	#4 4.75mm	+/- 0.15mm

Kentucky Method 64-629-14
Revised 08/04/14
Supersedes KM 64-629-08
Dated 03/13/08

LENGTH CHANGE OF HARDENED CONCRETE DUE TO ALKALI-CARBONATE REACTIVITY

1. SCOPE:

- 1.1 This method covers the test to determine the reactivity of aggregate in concrete specimens stored in a highly alkaline environment for a period of 180 days.

2. APPARATUS:

- 2.1 Length change comparator accurately reading to the 0.0001 inch is required.
- 2.2 Reference bar.
- 2.3 Water storage tank conforming to ASTM C 511.
- 2.4 Mechanical Concrete Mixer conforming to ASTM C 192.
- 2.5 Slump Apparatus conforming to Kentucky Method 64-302.
- 2.6 Air Content Apparatus conforming to Kentucky Method 64-303.
- 2.7 Stainless steel concrete beam molds conforming to ASTM C 666.
- 2.8 Gauge studs.
- 2.9 Tamping rod with 5/8" diameter and one with 3/8" diameter.
- 2.10 Mallet with rubber head.
- 2.11 4" x 8" Cylinder molds.
- 2.12 Steel bar.
- 2.13 Sieves. #8 or #16 and #200.

3. TEST SPECIMENS

- 3.1 Prepare and cure test specimens in accordance with ASTM C 192 with the following exceptions and or modifications.
 - 3.1.1 Subsection 4.1. Specimens shall be 3"x 4"x 16" where the gauge length is 14.75". The gauge length is the innermost length between the gauge studs within a concrete beam.

- 3.1.2 Subsection 5.4. Two concrete beam test specimens shall be made and tested. One concrete 4x8 cylinder shall be made and tested for compressive strength at 28 days.
- 3.1.3 Subsection 6.3. Use coarse aggregate as received, it is not necessary to grade out.
- 3.1.4 Subsection 6.3.1. Fine aggregate shall be natural sand meeting requirements of 804.03 and kept in moist condition. A moisture test shall be run prior to mixing so the weight of the water is factored into the mixing weights. Refer to Table 1 for batch weights.
- 3.1.5 Subsection 6.3.2.2. Batch weight of oven dried coarse aggregate shall be immersed in water approximately 24 hours prior to mix. Excess water is decanted over a #200 sieve to preserve fines. Then all + #200 material is placed in the mixer. Remember to use a larger sieve to protect the #200. Refer to Table 1 for batch weights.
- 3.1.6 Subsection 6.5. Master Builder's MicroAir air entraining admixture shall be used in a quantity sufficient to achieve an acceptable air content.
- 3.1.7 Subsection 7.2. Slump conforming to Kentucky Method 64-302. Air Content conforming to Kentucky Method 64-303. Refer to Table 1 for limits. Yield and Temperature are not required.
- 3.1.8 Subsection 7.4. Method of consolidation shall be rodding.
- 3.1.9 Subsection 7.5. Label the concrete beam specimens by scratching the sample ID into the finished surface. This should be done before the concrete is fully set and avoid disturbing the underlying aggregate.
- 3.1.10 Subsection 8.1. Concrete beams shall be covered with a layer of wet cloth and then with a layer of plastic to prevent rapid evaporation for the first 22 ±2 hours.

4. PROCEDURE

- 4.1 Specimen lengths shall be measured immediately after removal from molds to the nearest 0.0001 inch. This measurement is recorded as the 24 hour length reading.
- 4.2 When obtaining length comparator readings always measure beam in same orientation.
- 4.3 Immediately following the recording of the 24 hour length measurement, place specimens in storage tanks filled with water saturated in calcium hydroxide (hydrated lime) in accordance with ASTM C 511. This needs to be done as quickly as possible to prevent loss of moisture.
- 4.4 Place specimens in the tank in a manner that would not restrict expansion. Do not place any weight on the pins on either end of the beams.

- 4.5 Specimens shall have a second length measurement taken at 90 days and the third and final length measurement at 180 days.
- 4.6 Both test specimens must complete the 180 day test for a valid result.

5. CALCULATION

- 5.1 The formula used for this method is as follows:

$$L_c = ((l_2 - l_1) / L_g) \times 100$$

Where:

L_c = length change of the test specimen.

l_1 = length comparator reading at 24 hours.

l_2 = length comparator reading at 6 months.

L_g = the effective gauge length between the innermost ends of the gauge studs.

- 5.2 Calculate expansions to the nearest 0.001% and report the average expansion of the sample to the nearest 0.01%
- 5.3 The effective gauge length shall be 14.75 inches for this method.

6. REPORT

- 6.1 Reports shall contain the following information:

6.1.1 Sample identification

6.1.1.1 Sample ID #

6.1.1.2 Source/Quarry Name

6.1.1.3 Source/Quarry state ID # if applicable

6.1.1.4 Bench and/or Ledge designation

6.1.1.5 Size aggregate used

6.1.2 Dates

6.1.2.1 Aggregate sample date

6.1.2.2 Date sample was mixed into concrete

6.1.2.3 Test completion date

6.1.3 Slump test results for Kentucky Method 64-302

6.1.4 Air content of freshly mixed concrete test results for Kentucky Method 64-303.

6.1.5 24 hour, 90 day, and 180 day length comparator measurements.

6.1.6 90 day and 180 day expansions for each specimen.

6.1.7 Average 180 day expansions for both specimens reported to the nearest 0.01%.

6.1.8 Pass/Fail determination.

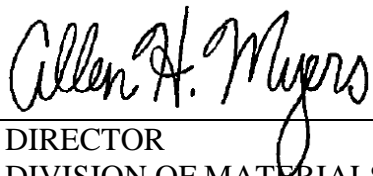
APPROVED 

DIRECTOR
DIVISION OF MATERIALS

DATE 08/04/14

Kentucky Method 64-629-14
Revised 08/04/14
Supersedes KM 64-629-08
Dated 03/13/08

Attachment

TABLE 1

LIMESTONE SPECIMENS (2 BEAMS)

	Size #57's, 67's & 68's	Size # 8's, 9m's & 78's
Type 1 Cement	16.6 lbs.	16.6 lbs.
Concrete Sand	35.2 x (1.00 + % Moisture of sand in decimal) ex. 3.4% moisture 35.2 x 1.034 = 36.4 lbs.	39.2 x (1.00 + % Moisture of Sand in decimal) ex. 3.4% moisture 39.2 x 1.034 = 40.5 lbs.
Coarse Aggregate	54.6 lbs.	50.7 lbs.
% Air KM64-303	4-8 %	5-9%
Air Entrainment	5.0 ml (Adjust As Needed)	5.0 ml (Adjust As Needed)
Slump KM64-302	2-4 Inches	2-4 Inches
Estimated Water (lbs.)	3.5-4.5 lbs. (Adjust As Needed)	3.5-4.5 lbs. (Adjust As Needed)

Kentucky Method 64-630-16
Revised 11/03/16
Supersedes KM 64-630-16
Dated 09/16/16

FLAT AND ELONGATED PARTICLES IN COARSE AGGREGATES

1. SCOPE:

- 1.1 This method covers the determination of Flat and Elongated Particles in Coarse Aggregate. Although this method has been written around state practices, ASTM D4791 was used as a reference.

2. APPARATUS:

- 2.1 Proportional Caliper Device consisting of a base plate with two fixed posts and a swinging arm mounted between them so that the openings between the arms and the posts maintain a constant ratio. The axis position can be adjusted to provide the desired ratio of opening dimensions. (See picture below.)

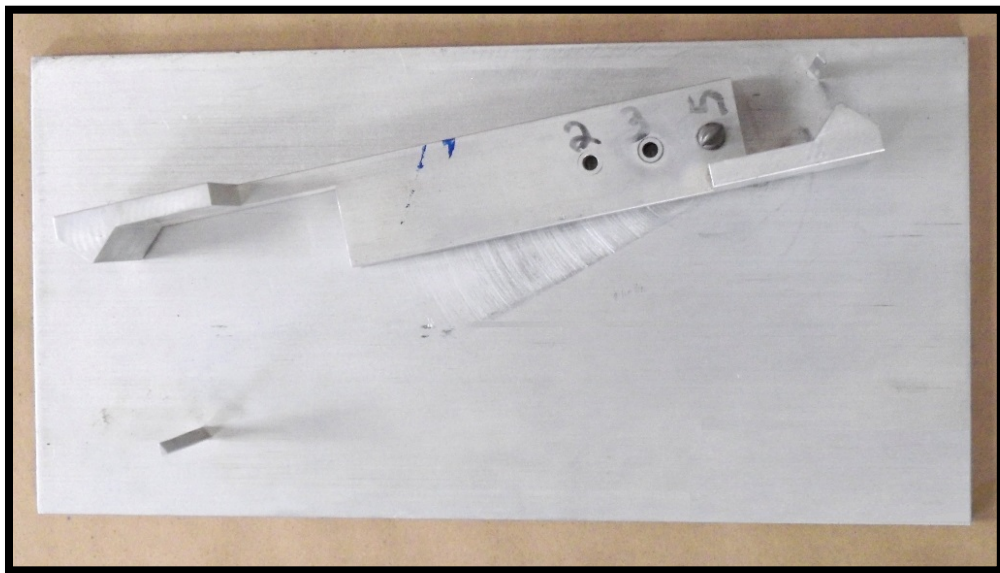

- 2.2 Sieves – Sieves shall conform to AASHTO M 92.
- 2.3 Scale/Balance – Scale or Balance accurate and readable to within 0.1 % of the test sample mass at any point within the range of use.
- 2.4 Sample Splitter

3. SAMPLING:

- 3.1 Sample the aggregate by KM64-601 SAMPLING OF AGGREGATES FOR USE AS HIGHWAY MATERIALS. The minimum field sample size is listed in KM64-601.
- 3.2 Thoroughly mix the sample and reduce it by KM 64-632. The minimum test sample size is listed in the following table.

Nominal Maximum Size (in)	Minimum Mass of Test Sample kg (lb)
2	20 (44)
1 1/2	15 (33)
1	10 (22)
3/4	5 (11)
1/2	2 (4)
3/8	1 (2)

4. PROCEDURE:

- 4.1 Dry the sample to a constant mass at $230 \pm 9^{\circ}\text{F}$ ($110 \pm 5^{\circ}\text{C}$).
- 4.2 Sieve the sample to be tested in accordance with AASHTO T27. Use the material retained on each sieve above and including the 4.75 mm (No. 4) sieve. Reduce the material until approximately 100 particles are obtained for each size fraction.
- 4.3 Use the proportional caliper device positioned at the 5:1 ratio.
- 4.4 Test all of the particles and place in one of two groups: (1) flat and elongated or (2) not flat and elongated.
- 4.5 On a proportional caliper device similar to the device shown, set the larger opening equal to the length of the particle (the longest dimension). The particle is flat and elongated if the particle, when oriented to measure its thickness (the smallest dimension), can pass completely through the smaller opening of the proportional caliper device. (See following pictures.)

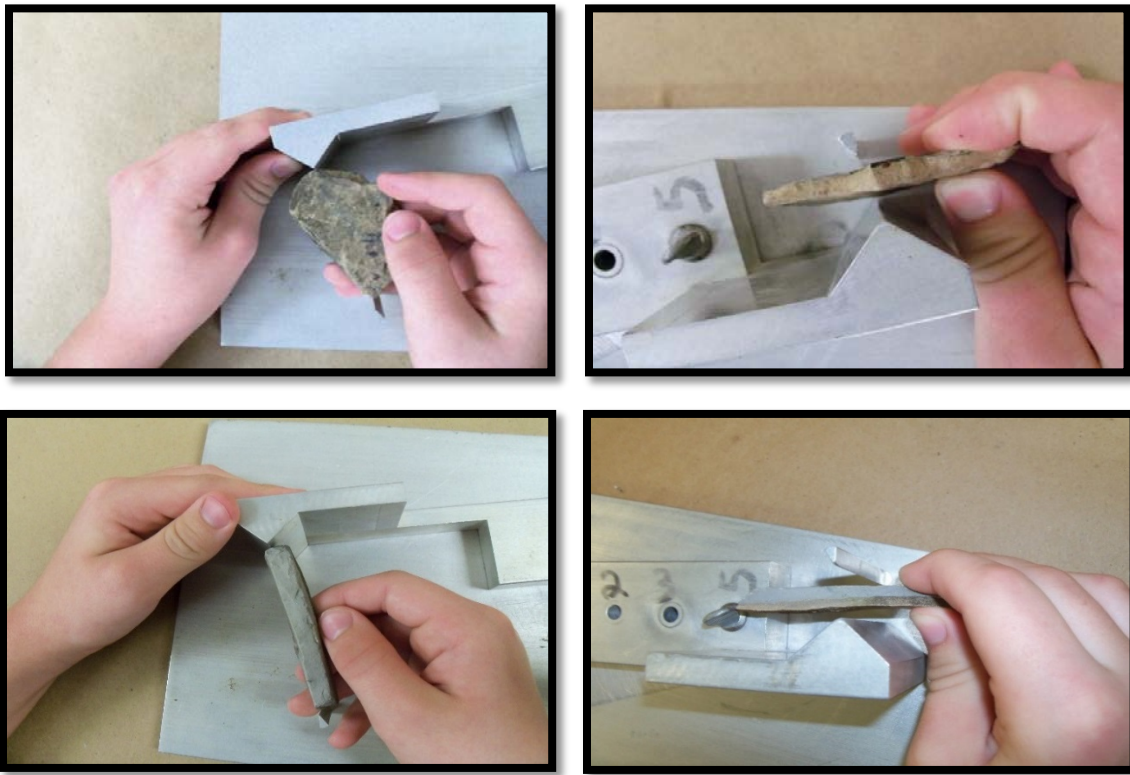

5. CALCULATION:

- 5.1 Calculate and round the percentage of flat and elongated particles to the nearest 1 % in accordance with the following:

$$\% \text{ Flat and Elongated} = \left(\frac{F}{F+N} \right) \times 100$$

Where:

F = mass of flat and elongated particles

N = mass of not flat and elongated particles

- 5.2 The Central Office, Division of Materials shall be the final authority in all disputes involving the determination of Flat and Elongated Particles in Coarse Aggregates.

APPROVED

Allen H. Myers

 DIRECTOR
 DIVISION OF MATERIALS

DATE

11/03/16

Kentucky Method 64-630-16
 Revised 11/03/16
 Supersedes KM 64-630-16
 Dated 09/16/16

KM 64-630-16

PERCENTAGE OF CRUSHED PARTICLES IN COARSE AGGREGATE

1. SCOPE:

1.1 This method covers the determination of Crushed Particles in Coarse Aggregate. Although this method has been written around state practices, ASTM D5821 was used as a reference.

2. APPARATUS:

2.1 Sieves – Sieves shall conform to AASHTO M 92.

2.2 Scale/Balance – Scale or Balance accurate and readable to within 0.1 % of the test sample mass at any point within the range of use.

2.3 Sample Splitter

3. SAMPLING:

3.1 Sample the aggregate by KM64-601 SAMPLING OF AGGREGATES FOR USE AS HIGHWAY MATERIALS. The minimum field sample size is listed in KM64-601.

3.2 Thoroughly mix the sample and reduce it by KM 64-632. The minimum test sample size is listed in the following table:

Nominal Maximum Size (in)	Minimum Mass of Test Sample g (lb.)
2	15000 (33)
1 1/2	7500 (16.5)
1	3000 (6.5)
3/4	1500 (3)
1/2	500 (1)
3/8	200 (0.5)

4. PROCEDURE:

4.1 Shake and wash the sample over a #4 sieve

4.2 Dry the sample to a constant mass at $230 \pm 9^{\circ}\text{F}$ ($110 \pm 5^{\circ}\text{C}$).

- 4.3 Spread the dried test sample on a clean flat surface large enough to permit careful inspection of each particle. To verify that a particle meets the fracture criteria, hold the aggregate particle so that the face is viewed directly. If the face constitutes at least one quarter of the maximum cross-sectional area of the rock particle, consider it a fractured face. (refer to picture on following pages).
- 4.4 Place the particle in one of three piles. (refer to pictures on following pages)
 - 4.4.1 No fractured faces
 - 4.4.2 Only one fractured face
 - 4.4.3 Two or more fractured faces.

5. REPORT:

Report the mass percentage of particles with the specified number(s) of fractured faces to the nearest 1 % in accordance with the following:

5.1
$$P = \left(\frac{F}{F+N} \right) X 100$$

Where:

P = % by weight of particles with at least the specified number of fractured faces.

F = mass of fractured particles with at least the specified number of fractured faces

N = mass of particles not having the minimum fractured faces

- 5.2 The Central Office, Division of Materials shall be the final authority in all disputes involving Percent of Crushed Particles in Coarse Aggregates.

APPROVED Allen H. Myers
 DIRECTOR
 DIVISION OF MATERIALS

DATE 09/16/16

Kentucky Method 64-631-16
 Revised 11/03/16
 Supersedes KM 64-631-16
 Dated 09/16/16

Attachments



No Fractured
Faces



Only 1 Fractured
Face



2 or more
Fractured Faces



Small nick less than $\frac{1}{4}$ of
the cross sectional area
(not a fractured face)

REDUCING SAMPLES OF AGGREGATE FOR TESTING PURPOSES

1. SCOPE:

- 1.1. This method covers the procedure used for reducing large samples of aggregate to the appropriate size for testing. Although this method has been written around state practices, AASHTO R76 was used as a reference.

2. SELECTION OF METHOD:

- 2.1. Fine Aggregate samples that are in a dry condition (see Note 1) shall be reduced by a mechanical splitter according to Method A. Samples that have moisture on the particle surface may be reduced by quartering according to Method B or sampled as a miniature stockpile as described in Method C.
 - 2.1.1. Fine samples that are not dry may be dried and then split by Method A.
 - 2.1.2. Fine samples that are dry may have moisture added to the material, mixed thoroughly and then reduced using Method B or Method C.
- 2.2. Coarse Aggregates that are in a dry condition may be reduced using a mechanical splitter in accordance with Method A (preferred method). Coarse Aggregates that are dry or damp may be reduced by quartering in accordance with Method B. The miniature stockpile Method C is not permitted for coarse aggregates or mixtures of coarse and fine aggregates.
- 2.3. Combined Coarse and Fine Aggregate samples that are in a dry condition may be reduced in size by either Method A or Method B. Samples having free moisture on the particle surfaces may be reduced in size by quartering according to Method B. When Method A is desired and the sample is damp, dry the sample until it appears dry or until clumps can be easily broken by hand (Note 1). Dry the entire sample to this condition, using temperatures that do not exceed those specified for any of the tests contemplated, and then reduce the sample. The miniature stockpile Method C is not permitted for combined aggregates.

Note 1—Dryness of the sample can be tested by tightly squeezing a small portion of the sample in the palm of the hand. If the cast crumbles readily, the sample is dry enough to be reduced in a mechanical splitter.

3. SAMPLING:

3.1. The samples of aggregate obtained in the field shall be taken in accordance with [KM 64-601](#).

4. METHODS OF REDUCTION:

4.1. METHOD A - MECHANICAL SPLITTER

4.1.1. APPARATUS:

4.1.1.1. Sample Splitter – Sample splitters shall have an even number of equal-width chutes, but not less than a total of eight for coarse aggregate, or twelve for fine aggregate, which discharge alternatively to each side of the splitter. For coarse aggregate and mixed aggregate, the minimum width of the individual chutes shall be approximately 50 percent larger than the largest particles in the sample to be split. For dry fine aggregate in which the entire sample will pass the 3/8" sieve, the minimum width of the individual chutes shall be at least 50 percent larger than the largest particles in the sample and the maximum width shall be 3/4". The splitter shall be equipped with a hopper or straight-edged pan, which has a width equal to or slightly less than the overall width of the assembly of chutes, by which the sample may be fed at a controlled rate to the chutes. The splitter and accessory equipment shall be so designed that the sample will flow smoothly without restriction or loss of material.

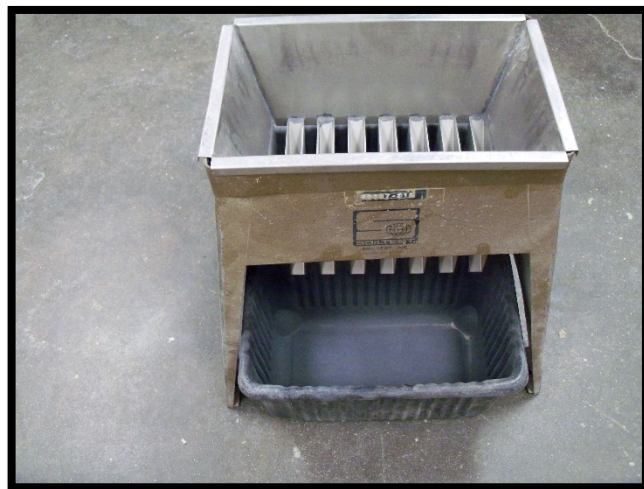

4.1.2. PROCEDURE:

4.1.2.1. Place the original sample in the hopper or pan and uniformly distribute it from edge to edge, so that when it is introduced into the chutes, approximately equal amounts will flow through each chute. The rate at which the sample is introduced shall be such as to allow free flow through the chutes into the receptacles below.

4.1.2.2. Reintroduce the portion of the sample in one of the receptacles into the splitter as many times as necessary to reduce the sample to the size specified for the intended test. The portion of the material collected in the other receptacle may be reserved for reduction in size for other tests.

4.2. METHOD B - QUARTERING:

4.2.1. APPARATUS:

4.2.1.1. Flat point shovel, scoop or trowel

4.2.1.2. Broom or brush

4.2.1.3. Canvas blanket or tear-resistant tarp.

4.2.2. PROCEDURE:

4.2.2.1. Place the original sample on a hard, clean, flat surface where there will be neither loss of material nor contamination. Thoroughly mix the sample and form a pile. Divide the pile into four equal quarters with a shovel or trowel and remove two diagonally opposite quarters, including all fine material. The two unused quarters may be set aside for later use or testing. Successively mix and quarter the remaining material until the sample is reduced to the desired size.



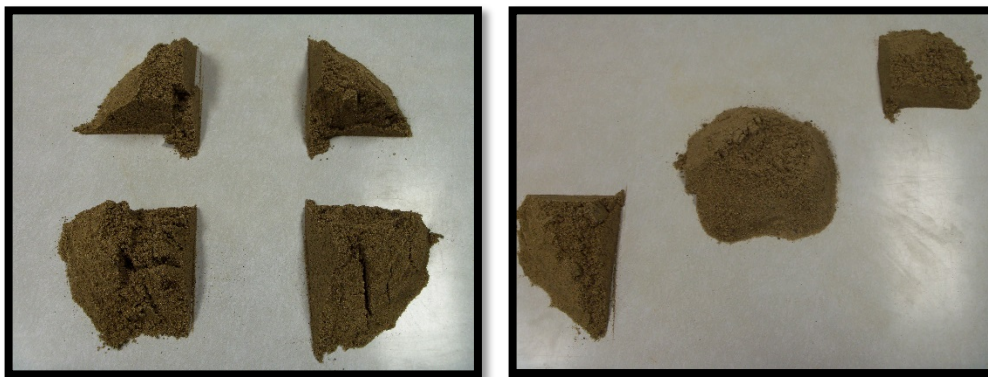

4.2.2.2.If the floor surface is uneven the field sample may be placed on a tear-resistant tarp and mixed with a shovel or trowel to eventually form a pile. As an alternative to mixing with the shovel or trowel, lift each corner of the tarp and pull it over the sample toward the diagonally opposite corner, causing the material to be rolled. After the material has been rolled so that it is thoroughly mixed, pull each corner of the tarp toward the center of the pile so the material will be left in a pile. Insert a stick or pipe beneath the tarp and under the center of the pile, then lift both ends of the stick, dividing the sample into two equal parts. Remove the stick, leaving a fold of the blanket between the divided portions. Insert the stick under the center of the pile at right angles to the first division and again lift both ends of the stick, dividing the sample into four equal parts. Remove two diagonally opposite quarters, being careful to clean the fines from the tarp. The two unused quarters may be set aside for later use or testing. Successively mix and quarter the remaining material until the sample is reduced to the desired size





4.3. METHOD C - MINIATURE STOCKPILE SAMPLING (DAMP FINE AGGREGATE ONLY):

4.3.1. APPARATUS:

4.3.1.1. Flat point shovel, scoop or trowel

4.3.1.2. Broom or brush

4.3.2. PROCEDURE:

4.3.2.1. Place the original sample on a hard, clean flat surface where there will be neither loss of material nor contamination. Thoroughly mix the sample and form a pile. Obtain a sample for each test by selecting at least three increments of material at random locations from the miniature stockpile.



APPROVED

Allen H. Myers

DIRECTOR
DIVISION OF MATERIALS

DATE

11/01/16

Kentucky Method 64-632-16

Dated 11/1/16

KM 64-632-16